

**Inductive sensor**  
**BI2-M12-AN6X-H1141**

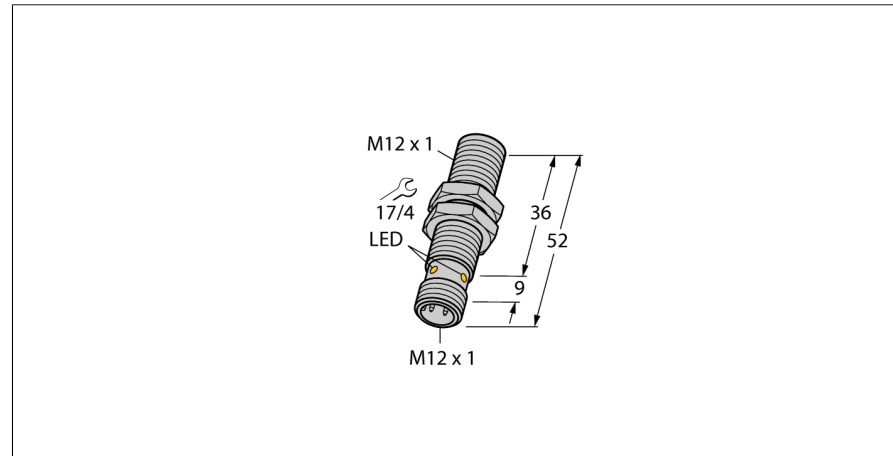

- Threaded barrel, M12 x 1
- Chrome-plated brass
- DC 3-wire, 10...30 VDC
- NO contact, NPN output
- M12 x 1 male connector

**Wiring diagram**

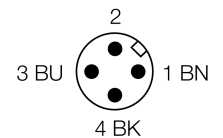
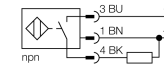

<b>Type code</b>	BI2-M12-AN6X-H1141
Ident no.	46066
<b>Rated operating distance Sn</b>	2 mm
Mounting condition	flush
Assured switching distance	≤ (0,81 x Sn) mm
Repeatability	≤ 2 % of full scale
Temperature drift	≤ ± 10 %
Hysteresis	3...15 %
Ambient temperature	-25...+70 °C
<b>Operating voltage</b>	10...30VDC
Residual ripple	≤ 10 % U <sub>ss</sub>
DC rated operational current	≤ 200 mA
No-load current I <sub>0</sub>	≤ 15 mA
Residual current	≤ 0.1 mA
Rated insulation voltage	≤ 0.5 kV
Short-circuit protection	yes/ cyclic
Voltage drop at I <sub>0</sub>	≤ 1.8 V
Wire breakage / Reverse polarity protection	yes/ complete
Output function	3-wire, NO contact, NPN
Switching frequency	2 kHz
<b>Construction</b>	threaded barrel, M12 x 1
Dimensions	52 mm
Housing material	metal, CuZn, chrome-plated
Material active area	plastic, PA
Max. tightening torque housing nut	10 Nm
Connection	male, M12 x 1
Vibration resistance	55 Hz (1 mm)
Shock resistance	30 g (11 ms)
IP Rating	IP67
MTTF	2283 years acc. to SN 29500 (Ed. 99) 40 °C
<b>Switching state</b>	LED yellow

**Functional principle**

Inductive sensors detect metal objects contactless and wear-free. For this, they use a high-frequency electromagnetic AC field that interacts with the target. Inductive sensors generate this field via an RLC circuit with a ferrite coil.

We offer special versions for temperatures of -60 °C up to +250 °C.

**Inductive sensor**  
**BI2-M12-AN6X-H1141**

Distance D	24 mm
Distance W	3 x Sn
Distance T	3 x B
Distance S	1.5 x B
Distance G	6 x Sn
<hr/>	
Diameter of the active area B	Ø 12 mm



**Inductive sensor  
BI2-M12-AN6X-H1141**

**TURCK**

Industrial  
Automation

**Accessories**

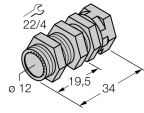
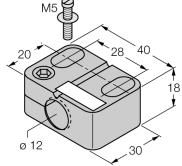
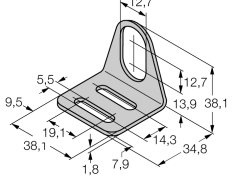
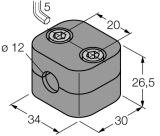
Type code	Ident no.	Description	Design
QM-12	6945101	Quick-mount bracket with dead-stop; material: Chrome-plated brass Male thread M16 x 1. Note: The switching distance of proximity switches can be reduced by the use of quick-mount brackets.	
BST-12B	6947212	Fixing clamp for threaded barrel devices, with dead-stop; material: PA6	
MW-12	6945003	Mounting bracket for threaded barrel devices; material: Stainless steel A2 1.4301 (AISI 304)	
BSS-12	6901321	Mounting bracket for smooth and threaded barrel devices; material: Polypropylene	

**Wiring accessories**

Type code	Ident no.	Description	Design
RKC4T-2/TEL	6625010	Connection cable, female M12, straight, 3-pin, cable length: 2 m, sheath material: PVC, black; cULus approval; other cable lengths and qualities available, see <a href="http://www.turck.com">www.turck.com</a>	