

# SBC System catalogue

2014 | 2015



**Electronic instrumentation, control and automation technology**  
for machines, facilities and real estate







# Contents

## Products

<b>A1</b>	Automation stations: Saia PCD3 – Saia PCD2 – Saia PCD1	7
<b>A2</b>	HMI Visualization and operating	83
<b>A3</b>	Dedicated room controllers	97
<b>A4</b>	Consumption data capture	113
<b>A5</b>	Accessories for automation technology	133

## Basic systems

<b>B1</b>	Software for Windows® PCs	145
<b>B2</b>	Communication & Interaction	189
<b>B3</b>	SBC S-Web: Visualisation–Trending Alarming	223

## Appendix

<b>C1</b>	Project help	243
<b>C2</b>	Status: Product launch	249
<b>C3</b>	Type listing	251

This catalogue presents the current product range for the automation of technical infrastructure. It includes facilities for energy production and distribution, water supply, telecommunications, transport networks and HVAC facilities in buildings.

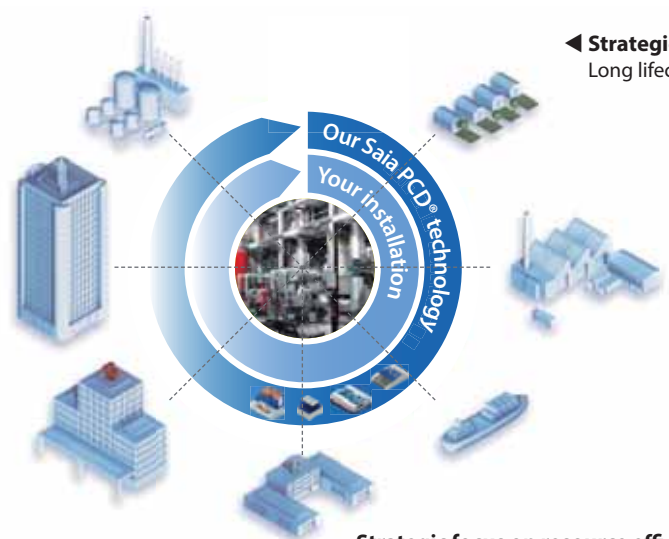

◀ **Strategic focus on primary systems with SBC technology**  
Long lifecycle, adaptable, expandable

This catalogue does not cover all the products supplied by Saia Burgess Controls. An aware choice based on relevance was made for as many of our customers as possible.

**This resulted in the following focus topics:**

- ▶ Instrumentation, control and automation (ICA) technology of primary installations
- ▶ Increased efficiency when using natural resources
- ▶ Technical integration and automation of buildings

**Strategic focus on resource efficiency ▶**

Record, display and control the consumption of electricity, water, gas, heating, etc. with SBC S-Monitoring Systems. Suitable for use everywhere where technology has to be easily and reliably integrated into operations but is to remain flexible and expandable – from residential homes to industrial facilities.

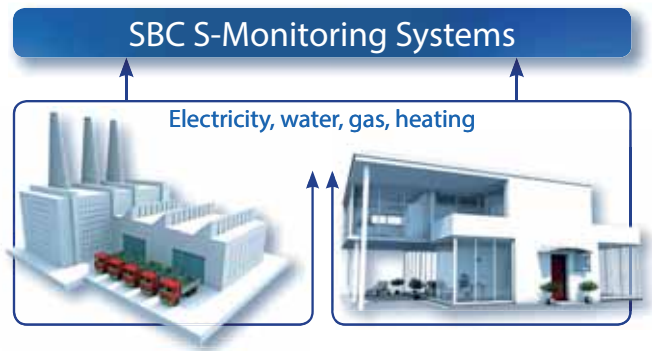

Our catalogue does not feature products with a lifecycle likely to end in a few years' time. We no longer recommend these "end of life" products when planning new projects. They will therefore no longer be listed in the manual. A list of all the available SBC products can only be found in the current price list. Here you will also find products which are specially designed for the automation of industrial production machines

**How can the SBC System Catalogue help you?**



**You invest, operate, manage...**

The catalogue provides an introduction on how to understand and be able to assess for yourself the qualities and properties of the ICA/automation technology you have integrated and/or planned. You can see which technical capabilities exist for operating infrastructure objects more cost-effectively and with less effort. You can recognize how you can avoid dependencies which are disadvantageous to your business. You can find products "Made for Lean Automation Technology" which are designed to give you more peace of mind.



**You plan, advise, calculate...**

You can find the technical basis for consulting, engineering and invitations to tenders. You can recognize how Saia PCD® technology can help you to achieve maximum flexibility in project implementation and the following optimization phase. Maximum flexibility helps you to deal with the 2 basic constants of the project business better and more easily. These include:

- a) You are lacking important information and requirements in the planning phase.
- b) The actual construction design deviates from your plan. Despite this, everything should be finished on time and within budget.



**You install, implement and provide service...**

Here you can find the general technical principles for mounting and cabling SBC device technology. You can understand how applications are created with SBC S-Engineering software tools and how they can be changed in the lifecycle. You can recognize which device, which software tools and application modules are suited to an invitation to tender or project description.

## Shared objectives

Being able to understand and assess products and their integration into systems is essential. Knowing what objectives they were created to achieve helps accomplish this. These objectives should largely be identical to those of operators, planners and integrators of ICA systems.

Shared objectives bring everyone together – just as the shared methods and values of the companies involved make collaboration easier and ensure success. The following two pages provide a short overview of this.

## Technical cornerstones

In order to achieve the shared objectives of operators and owners of automation systems, we need a suitable stable technical foundation.

This foundation comprises 4 basic properties which are common to all Saia PCD® controllers.

- 1 ▶ Modularity in hardware and function enables high flexibility and adaptability at any time during the lifecycle of 15...20 years.
- 2 ▶ Maximum portability: The project's application software can be ported over all device classes and device generations throughout the lifecycle; even by the owner/operator alone.
- 3 ▶ Complete openness in communication. All device functions and data can be seen from the outside and used. Complete openness also in licensing the SBC software tools, because SBC software tools are available to anyone.
- 4 ▶ Standard technology only: The ICA functions of Saia PCD® devices are implemented using standardized technology that is in common use and is recognized around the world (web + IT). We do not use proprietary technologies. Saia PCD® S-Bus is the exception. We need this in order to get right into the core of the Saia PCD® devices, e.g. debugging.

**Bus technology usable with Saia PCD® control devices:**  
other protocols can also be implemented later as a PLC program

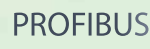

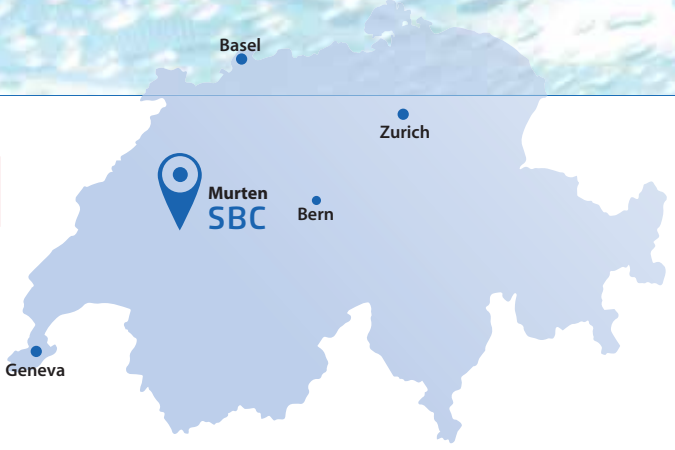

## About us ...

### Control systems "Swiss made"

Saia-Burgess Controls AG, or SBC, is based in a bilingual (German and French) part of western Switzerland – the locality which is home to companies with a global reputation and to leading schools and universities in the field of technology. Saia Burgess Controls is a wholly-owned subsidiary of Honeywell International Inc. and operates according to the "bottom up" principle: the needs of the grassroots are defined and integrated into the development and manufacturing process. The company has developed and marketed electronic components and

measurement and control systems since 1950. The products are distinguished by an extremely long service life. They are used in heating, ventilation and climate control, energy management and water systems. A further important pillar of the company is OEM production. SBC products are always fit for purpose and are guarantors of technological progress.

- Key corporate data
- 70 million euro annual sales ◀
  - 340 employees ◀
  - 2 million I/O points per year ◀
  - 40,000 CPUs per year ◀
  - 700,000 small devices/year ◀

### Our mission

Development, production and sale of industrial-grade electronic components and systems for control/automation engineering.



In the early days, Saia Burgess Controls manufactured mainly electronic timers. The spectrum of use extended from house installations to machine technology.

At the end of the seventies, Saia Burgess Controls became a pioneer in the field of programmable logic controllers (PLCs), known and used long-term under the Saia® brand name. In parallel with the component business, Saia Burgess Controls grew to become a supplier of measurement and control technology systems.

The year 2006 saw the start of the product line for fully integrated bus compatible electronic energy meters.



In the same year, Saia Burgess Controls launched the world's first completely web-based touch-panel for automation.



In 2010, with the complete redesign of the Saia PCD1, the smallest device series joined the Saia PCD3 and Saia PCD2 in being fully modernised. The 3rd generation of Saia PCD® control devices is now complete. This is characterised by the following equation:

**Saia PCD® = PLC + IT + Web**

Seamless integration of world renowned open technologies for web and IT on freely programmable, industrial electronics with the same quality and life cycle as the robust, industrial PLC.

### Value and culture of a PLC company

When they use our products customers gain value added in the form of sustainable earnings. For this reason, we develop products with a long life cycle of problem-free, reliable operation. Installed products can be adapted to changing needs at any time. Investments made by the customer are lasting and not constantly subject to incompatibilities or forced and unwanted innovations. This is why we develop PLC-based technology, with its sustained customer benefit and ease of upgrade. For more than 50 years, our company has remained true to these values.

Since application settings all too often fail to behave in accordance with the standards, we have made Saia PCD1, 2, 3 control technology more robust against interference than the CE standard requires. We set high standards for ourselves. This gives our customers greater security and peace of mind



Alongside the strict IEC 61131-2 PLC hardware standard, Saia PCD® control technology also meets the stringent requirements of various testing authorities for marine engineering.



#### IEC EN 61131-2

This standard defines in 150 pages how electronic items should be developed and produced to satisfy PLC quality requirements. It ensures, among other things, that service is possible even without specialists. Look out for the extension "-2". Many suppliers work only to PLC standard 61131-3. But that standard only defines the programming method type, regardless of the hardware/design quality. In addition, standard 61131-3 does not specify the portability of application software from one device series to another, nor from one hardware version to the next.





**From bid phase to production and far beyond:  
All in-house**



**Product Development**

Software, firmware and hardware developed in-house  
Guaranteed product life cycle and compatibility for over 15 years  
Faster and more reliable production of custom orders



**Production**

Two modern SMD lines with 560 feeder positions in the factory at Murten (Switzerland)  
Effective mounting capacity of 80,000 components per hour  
Selective soldering machine for processing densely populated, critical boards  
ICT, AOI and boundary scan test methods



**Assembly**

Production and assembly based on the "lean" principle  
Direct final assembly in work cells downstream of the SMD line, no intermediate storage  
A machine-assembled board becomes a finished product ready for dispatch, including packaging and documentation.



**Logistics**

- ▶ 75,000 order items
- ▶ 12,000 packages
- ▶ 1,000 sales items kept in stock
- ▶ Delivery reliability: >96%
- ▶ Delivery time: 80% of items within 48 hours



**Training and Support**

The aim is to achieve a high level of autonomy and efficiency for our customers.  
Product support and training centres at every sales support location  
Practical basic and advanced training facilities at the factory in Switzerland

**View of lifecycle for Saia PCD® control equipment**



Control and measurement electronics should have the same life cycle as the installation plant technology. During this cycle the technology must remain adaptable and expandable at all times; it should therefore be modular and in PLC quality.



The compatibility and free portability of system/machine software is safeguarded over an entire product generation of 18 to 25 years. This can only be achieved if we develop all the engineering software ourselves, and systematically use "interpreted program code". This approach requires rather more hardware resources, but allows user software to be portable across several controller generations.



**Our customer base**

The spread of our customers is a distinctive feature of our company. More than 50% of our corporate turnover is achieved with "small" system integrators, who carry out infrastructure automation projects. At the other end of the scale, we also develop and manufacture products for well-known international companies in electrical automation. Midway between the two are the production machine builders. Many of these supply HeaVAC and "energy" machines for infrastructure. In process technology, Saia PCD® controllers are found in machines for stoneworking, textiles, printing, assembly, etc. In the case of machine controllers, we have no specific industry focus but rather a customer focus. Target customers are manufacturers of production machines who value an economical and innovative controller technology that offers them ample room for their own added value and product differentiation. We provide our customers with individual adaptations to achieve maximum efficiency for their needs.





# Customer support

We consider service to be an integral part of the sale price. As a result, our customers experience success and delight when using our products. For us, satisfaction is not an option or an "accessory", but part of the basic product. As a system manufacturer, our support expertise goes far beyond one single device. Our products are components and systems.

## Lean automation support

The greatest benefits are achieved with minimum operating costs if the requirements profile of the user/operator is implemented as perfectly as possible in automation solutions. This profile only becomes clear in long-term operation and when there is good knowledge of the individual application. For this reason, people who implement and maintain the operational automation/ICA solution should be as close to the application as possible. SBC support is thus fully focused on achieving maximum autonomy and independence with high efficiency for system integrators, systems builders and operators. Saia Burgess Controls does not deal with the realization and maintenance of installed, fully operational automation/ICA solutions. A device manufacturer simply does not have the strategic starting position to be the best here.

## Quality and performance of SBC support

The quality and performance of our support determines our success. We regularly have independent institutes assess our customers' satisfaction with the support service. The results of the survey are checked for credibility by authorities such as the German company TÜV Süd before publication.

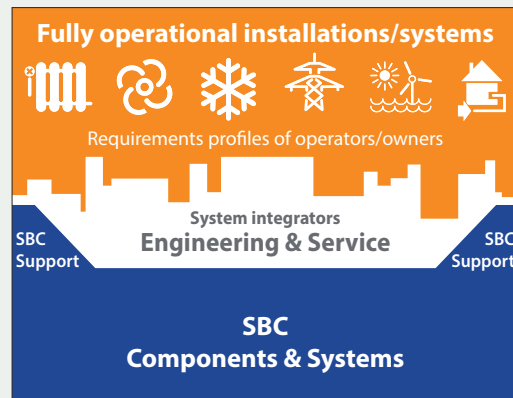
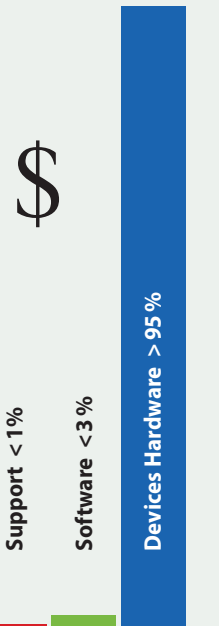

Our value contribution on the way to an installed and optimized ICA solution.

**Breakdown of sales Saia Burgess Controls:**  
 For us, revenue from service is of virtually no significance. We derive no profit from operator/owner problems and costs over the life cycle. SBC support is free of charge, because every device delivered includes support when needed.

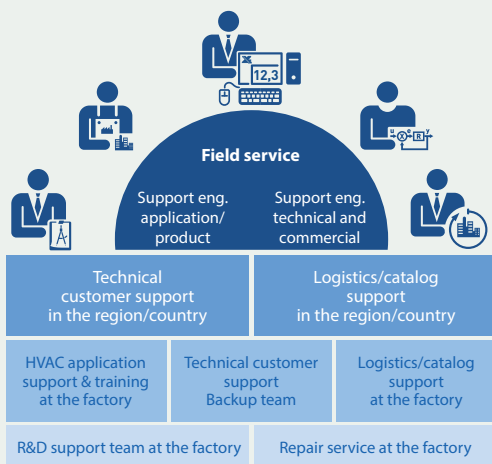

### Support structure for SBC components and systems

**Mission:** The logistics support ensures that products from the factory can be delivered within a week to each (industrialized) place on earth.

## SBC support structure

The satisfaction and economic success of the operator/user when using SBC technology is influenced by many groups of people. For this reason, SBC support specifically supports everyone involved in the planning, implementation and operation of facility installations. Support engineers are available to the customer for advice and assistance. The field service support engineers are assigned to a support center in the country/region. Their employees are available to all interested parties by phone, e-mail and NetMeeting. Where the scope and type of local resources is not sufficient, there is a further factory support level in the background. Large training facilities for HeaVAC technology are also provided here. Online help is available 24 hours a day, 7 days a week at [www.sbc-support.com](http://www.sbc-support.com).

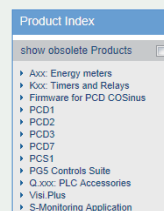

[www.sbc-support.com](http://www.sbc-support.com)  
 Online help is available 24/7.

# A

## Products

<b>A1</b>	Automation stations	
<b>A1.1</b>	System description	8
<b>A1.2</b>	Saia PCD3	19
<b>A1.3</b>	Saia PCD2	41
<b>A1.4</b>	Saia PCD1	53
<b>A1.5</b>	PCS1	65
<b>A1.6</b>	Remote data points	69
<b>A1.7</b>	Accessories for automation stations	77
<b>A2</b>	HMI Visualization and operating	83
<b>A3</b>	Dedicated room controller	97
<b>A4</b>	Consumption data acquisition	113
<b>A5</b>	Cabinet components	133



# A1

## Automation stations

Programmable controller for measuring, regulation and control tasks. Modular design consisting of industrial quality CPU, I/O and communication modules with life cycling lasting decades. The comprehensive application software can be simply and reliably adapted and extended throughout the life cycle. It is applied on all automation station series (Saia PCD1, 2, 3 and PCS1)



### 1.1 Basic properties of programmable Saia PCD® measuring, regulation and control devices

Presentation of the Saia PCD® Controls COSinus operating system – device platforms – program execution – memory system and service capability.



Page 8

### 1.2 Saia PCD3

Up to 1,023 I/Os – up to 13 simultaneously operated communication interfaces.

- ▶ Saia PCD3.Mxx6x as High Power CPU
- ▶ Saia PCD3.M5xxx as standard control device
- ▶ Saia PCD3.M3xxx as compact base unit
- ▶ Saia PCD3.M2 with dedicated I/O level and function

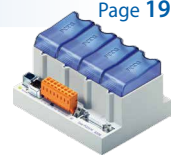

Page 19

### 1.3 Saia PCD2

External dimensions independent of the type and number of the integrated hardware modules. Extensible system to max. 1,023 I/Os – up to 15 simultaneously operated communication interfaces.



Page 41

### 1.4 Saia PCD1

18 integrated I/Os which can be extended to max. 50 I/Os with 2 optional I/O modules – up to 8 simultaneously operated communication interfaces.



Page 53

### 1.5 Saia PCD® PCS1

Programmable compact controller for HeaVAC applications. Tried and tested devices with 19, 30 and 44 I/Os for simple applications without Ethernet.



Page 65

### 1.6 Remote data points (RIOs)

- ▶ Saia PCD3.T66x Ethernet Smart Remote I/O Station with 4 I/O slots
- ▶ Saia PCD3.T760 as Profibus DP Remote I/O Station with 4 I/O slots
- ▶ Saia PCD7.Lxx S-Bus RIO modules



Page 69

### 1.7 Accessories for controllers

- ▶ Cables and connectors for SBC system
- ▶ External GSM, analog and ISDN modems for top-hat rail mounting
- ▶ Saia PCD4.U100 upgrade kit for operating old PCD4 modules on new SBC controllers



Page 77

1 Automation stations

2 HMI Visualization and operating

3 Dedicated room controller

4 Consumption data acquisition

5 Cabinet components

## 1.1 Saia PCD<sup>®</sup> system description

PLC + (web + IT) = Saia PCD<sup>®</sup>

Saia PCD<sup>®</sup>s combine PLC functionality with innovative web and IT technology in an industrial quality system. The base equation Saia PCD<sup>®</sup> = PLC + (web + IT) means that the conventional automation pyramid is becoming an open, transparent structure.

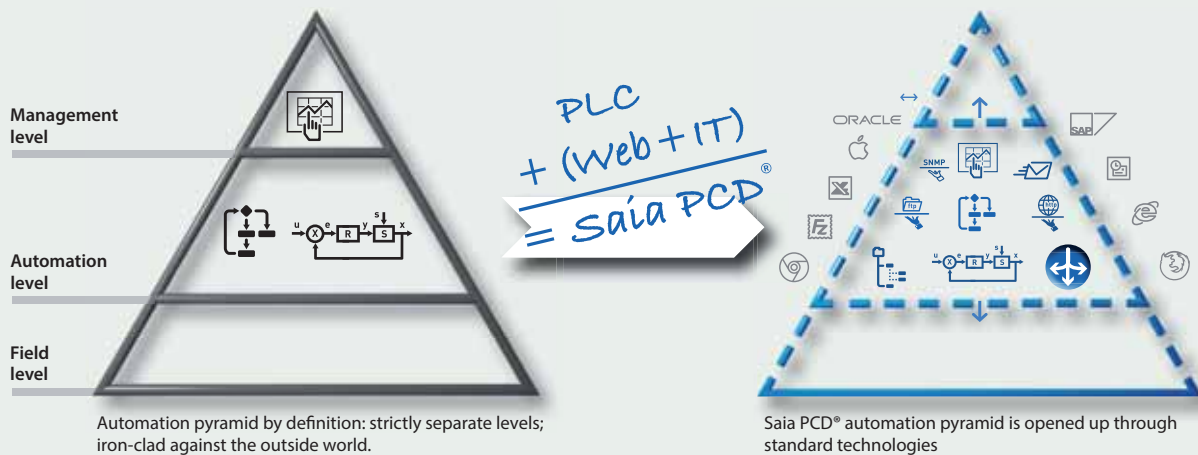

The Saia PCD<sup>®</sup> system with its open technology stands for total transparency, combinability and openness. This applies not only between all levels in the automation pyramid, but also between the automation world and the real, operational user environment. In order to achieve this, as a general rule all Saia PCD<sup>®</sup> control and regulation devices are provided with comprehensive web + IT functions. These functions do not require any additional hardware but are an integral part of every device. This means that machines and systems can be integrated into the existing IT infrastructure extremely easily.

### **Lifecycle of Saia PCD<sup>®</sup>: Compatibility and portability guaranteed for all device types across generations.**

We develop our products so that our customers in their use have a direct added value, namely to sustainably earn money. This requires products with a long life cycle and a trouble-free and reliable operation. Previously installed products must always be capable of being adapted to changed needs. Investments made should not be constantly wiped out by incompatibilities or forced innovations that no one requested.

This is why we attach such great importance to PLC-based technology, with its sustained customer benefit and ease of upgrade. For more than 50 years, our company has remained true to these values. That is why we only use components that comply with industrial standards and have a lifecycle of at least 20 years.

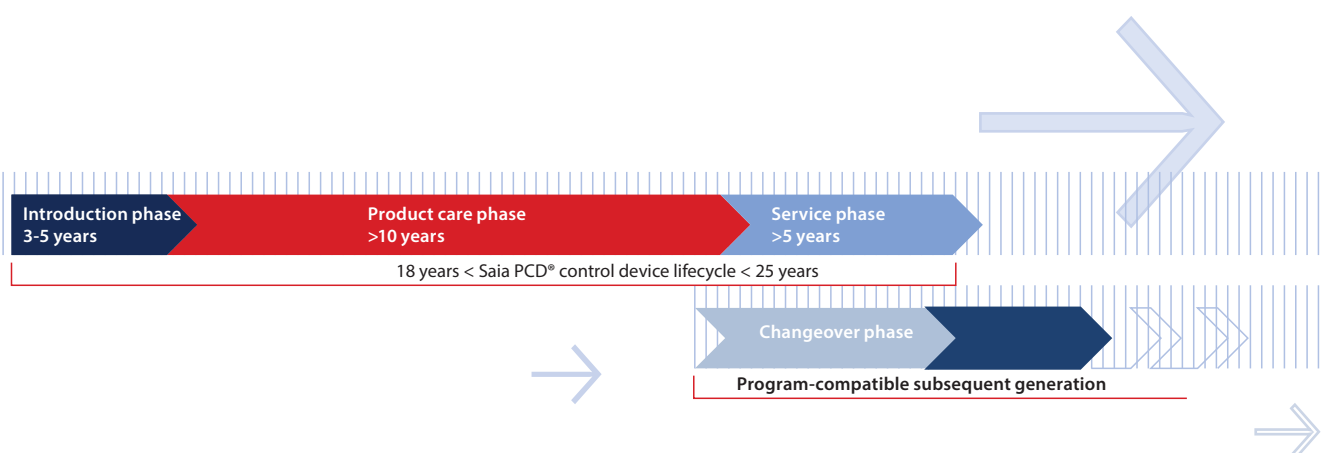





## Standards

Saia PCD® controllers comply with the IEC EN 61131-2 standard in terms of design and production quality. This standard defines in 150 pages how electronic items should be developed and produced to satisfy PLC quality requirements. All the important topics for the applications are covered: From the environmental conditions (temperature, humidity, vibration), to functionality (fluctuations in the power supply, interruptions) and electromagnetic compliance depending on the area of application.

Since application settings all too often fail to behave in accordance with the standards, we made control technology more robust against interference than the CE standard requires. The majority of Saia PCD®s are also approved for maritime applications, where increased demands are made on the devices.

The quality and robustness of the Saia PCD® controllers can also be seen in MTBF values, in the rates of returns from the field and in the feedback from the customer satisfaction surveys that we regularly carry out.

You can find further information on this on page 18.

1 Automation stations

2 HMI Visualization and operating

3 Dedicated room controller

4 Consumption data acquisition

5 Cabinet components

## Basic configuration of the Saia PCD® CPU modules

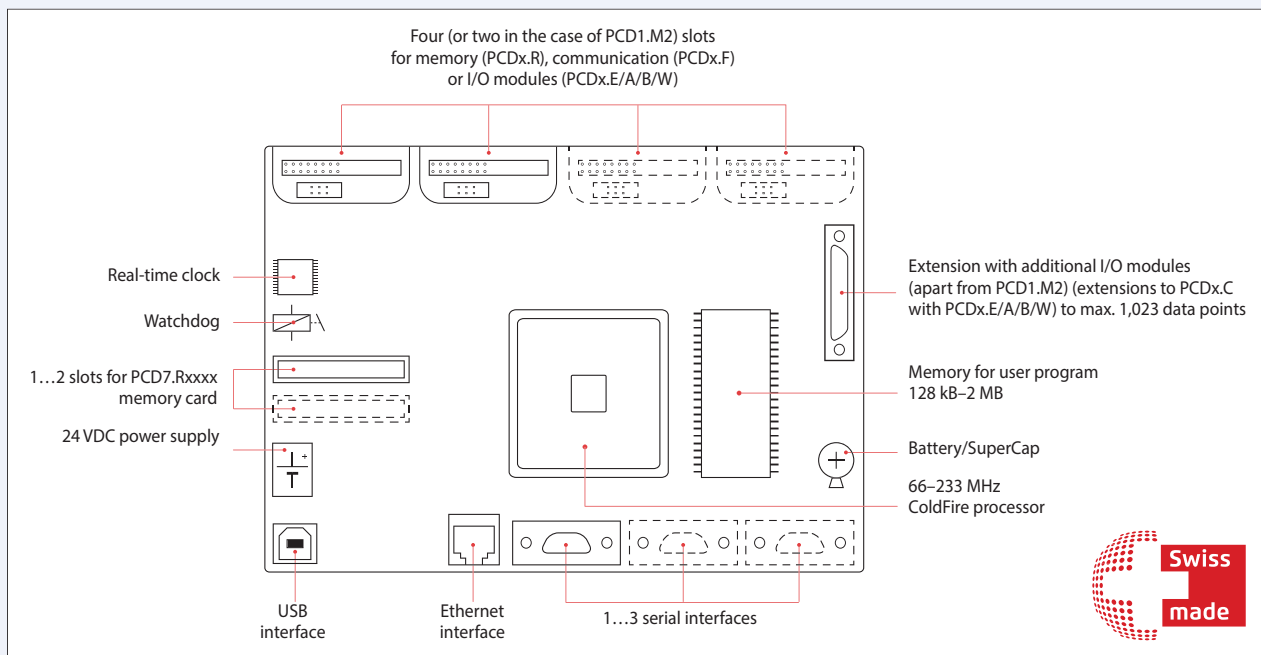

▲ Overview of the core elements of a Saia PCD® controller

### Saia PCD® hardware

#### Common properties

- ▶ USB interface for configuration, programming and commissioning
- ▶ Ethernet interface with all the important web/IT protocols, including those for PG5 communication
- ▶ At least one serial interface on-board (Saia PCD3.M5/6: 3×)
- ▶ 24VDC power supply
- ▶ Data remanence through battery and/or SuperCap
- ▶ Watchdog and fast interrupt inputs on the main CPU
- ▶ Slots for intelligent communication or memory modules
- ▶ Can be extended in a modular way (apart from Saia PCD1.M) to max. 1,023 central data points

## Saia PCD® COSinus – Control Operating System

The core of the Saia PCD® operating systems was developed by us between 2001 and 2003 as part of a European cooperation project with Philips and Nokia. We then expanded the core to an operating system for advanced, industry-quality measuring, control and regulation devices. A dedicated operating system for MRC technology – a control operating system (COS). Developed in-house and with all aspects fully mastered.

Saia PCD® COSinus combines user program and different hardware

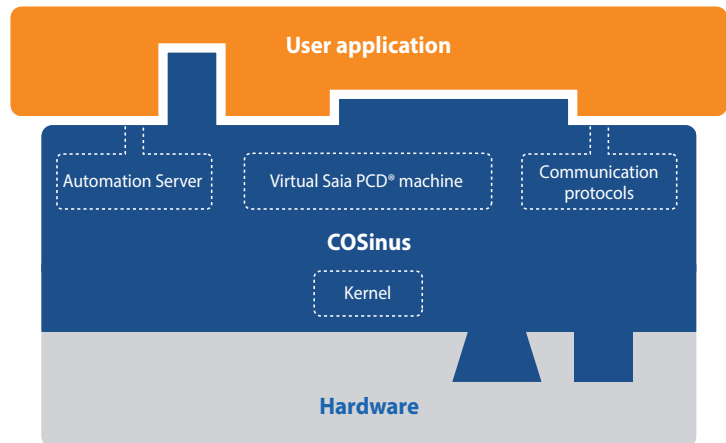

### The main components of Saia PCD® COSinus

- 1 Multi-tasking kernel: Abstracts the hardware, incl. I/Os, and communication interfaces, provides basic multi-tasking functionality on which the program processing of Saia PCD® programming is also based.
- 2 Virtual Saia PCD® machine: This is the actual logic machine that executes the PG5 programs. The virtual Saia PCD® code is interpreted and it guarantees that programs are always executed on different PCD controllers in the same way. The three hubs of the PG5 application program are the following:
  - ▶ Media: Memory of the virtual PCD machine such as registers, flags, counters, etc.
  - ▶ Program execution: Program & organization blocks, text, monitoring, error handling, memory management, etc.
  - ▶ System functions: Access to the hardware, I/Os, interfaces and drivers
- 3 Automation Server: The Automation Server includes widely used web/IT technologies and ensures data exchange between users and automation solutions without a need for proprietary hardware or software.
- 4 Communication protocols: Various field and automation protocols such as BACnet®, Lon, Profibus, Modbus, DALI, M-Bus, and many others.

### Why COSinus?

The control operating system (COS) ensures that customers' application software always runs on all platforms, is portable across device generations and extendable over several decades. Hardware and the Windows® programming tools may change, but the customer does not need to touch the application code. The hardware, software tool and application software are in a relationship like the sides of a triangle. If hardware and/or software changes, the angles have to adapt for the application software to remain the same. We extended the abbreviation COS to the name COSinus due to the trigonometric relationships in triangles.

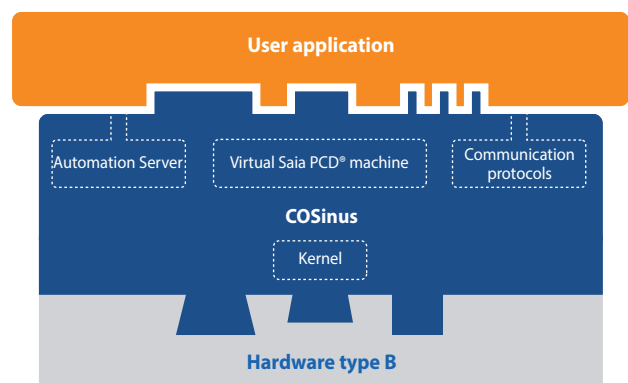
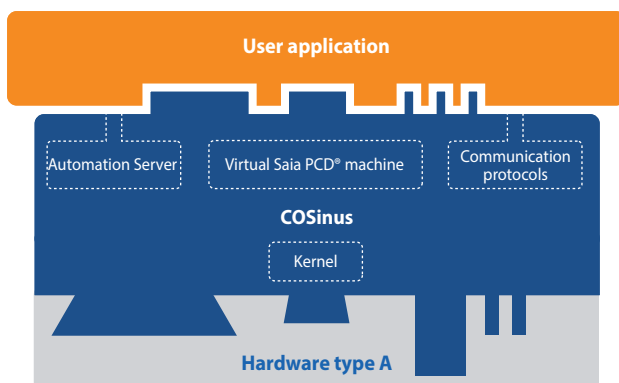

▲ The COSinus operating system always provides the application with the same infrastructure, regardless of the underlying hardware and processor. The key to this is the Saia virtual machine. It ensures that an application program created with PG5 works on all PCDs across generations.

## Execution of user program

The user program consists of one or more organization blocks that are executed by the PCD Interpreter. Each user program has at least one cyclical COB organization block, COB0.

The PCDs are mono-processor systems. Saia PCD® 1, 2, 3 control and regulation devices have a main processor that processes all the tasks. The user program has a specific role here and is treated as a core task. In addition to the user program, any communication tasks and server functions (web, FTP) still to be done are processed. The capacity of the CPU is divided accordingly. The cycle time for the user program not only depends on the length of the program itself but also on the additional load at the same time.

### Examples

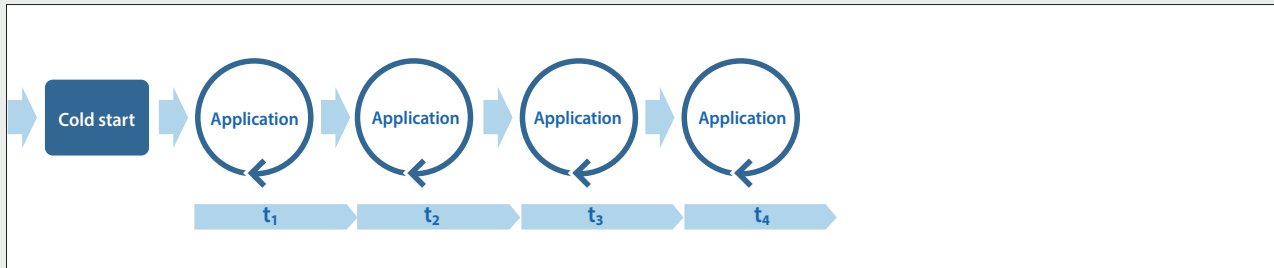

▲ Cycle time without any further communication

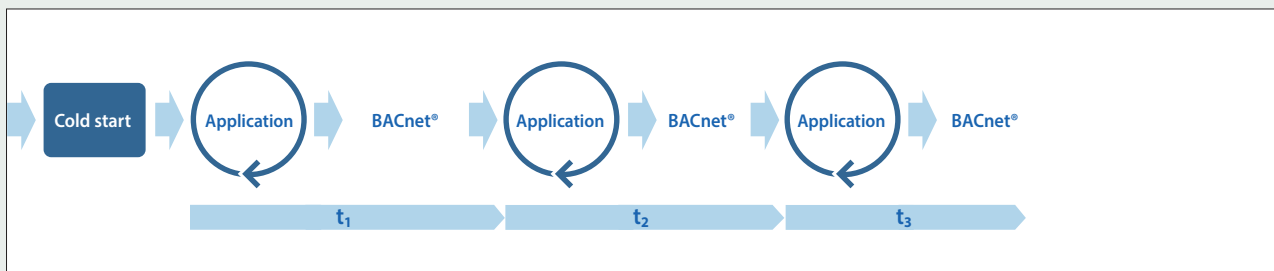

▲ Cycle time with BACnet® communication

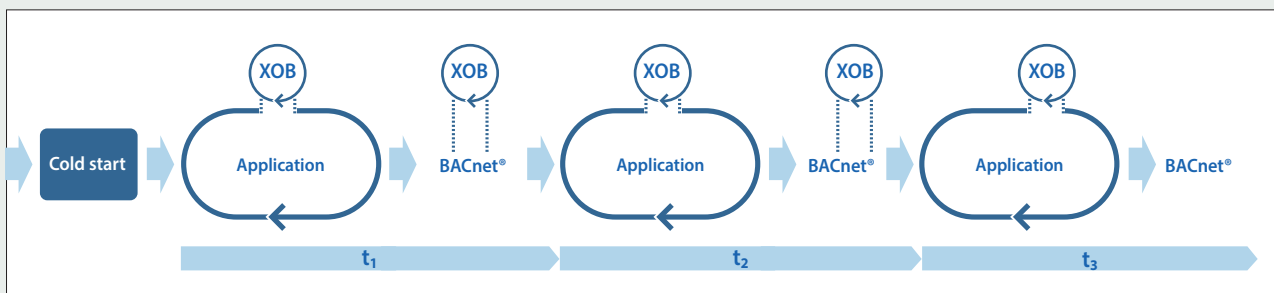

▲ Cycle time with BACnet® communication and interrupt (XOB)

The more communication takes place, the longer the cycle time ( $t_x$ ) and this may result in variation in the cycle time. If this variation in the cycle time is not desired, for example because regulation must take place in a fixed time period and ideally without any jitter, then you should ensure that this part of the program is executed in an XOB. The priority of the XOBs is higher than that of the COBs and higher than many other operating system tasks. The above example shows that a periodic XOB interrupts the cyclical program as well as the execution of the BACnet® task.



The COSinus operating system ensures that all tasks are processed. A sensible load balance must be maintained between the user program and communication. This actually always comes up in planning practice. It is only problematic if the contractor uses a weaker Saia PCD® CPU than planned in order to save money or completely "saves" on CPUs by concentrating tasks on one CPU.

### The main XOBs and their priority levels

Priority 4

▶ XOB 0: Network out

Priority 3

▶ XOB 7: System overload – called if the interrupt XOB queue is overflowing

▶ XOB 13: Error flag – called in the event of communication or calculation errors or in the event of an invalid instruction

Priority 2

▶ XOB 16: Cold start

▶ XOBs 14, 15: Periodic XOBs

▶ XOBs 20...25: Interrupts

Priority 1

▶ XOB 2: Battery failure

▶ XOB 10: Nesting depth exceeded when PB/FBs are called

▶ XOB 12: Index register overflow

### Data types and program blocks\*

Registers (32-bit): 16,384

Flags (1-bit): 16,384

Timers & Counters (31-bit): 1600

(Partitioning configurable)

Cyclic organization blocks (COB): 0...31

“Exception” organization blocks (XOB): 0...31

Program blocks (PB): 1000

Function blocks (FB): 2000

Text/data blocks (DB): 8192

Sequential blocks (SB): 96

You can find a complete list in the PG5 help.

\* This information is dependent on the hardware and the COSinus version.

### Saia PCD® opcode

Saia PG5® generates a platform-independent opcode that is interpreted by the Saia PCD®. As a result, the same program runs on different platforms. This also enables the user program to be updated by means of a flash card as the operating system of the Saia PCD® performs the necessary actions so that the program is copied from the flash card to the memory and run.

Code that is generated (= compiled) and optimized for the specific platform, of course, runs faster. This compiler is not integrated in the PC tool (Saia PG5®). Saia PCD® COSinus knows best how this code should be ideally implemented on the given hardware. The program is compiled when it is loaded in the Saia PCD®.

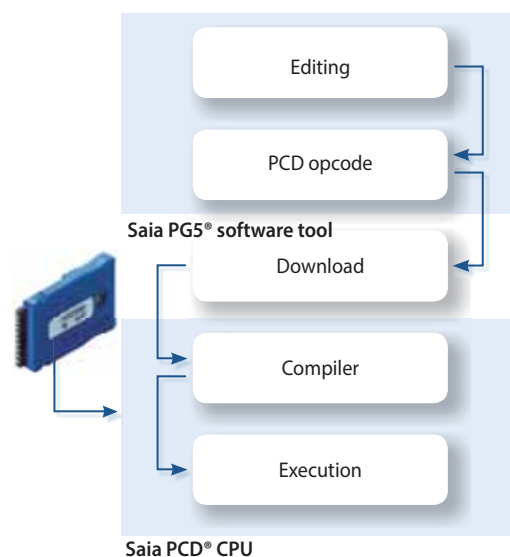

### Automation Server

The Automation Server is part of the COSinus operating system. It includes widely used web/IT technologies and ensures data exchange between users and automation solutions without a need for proprietary hardware or software.

Specially adapted automation functions and objects form the perfect counterpart for control uses. The web/IT functions can thus be optimally and seamlessly integrated into the automation device and efficiently used.

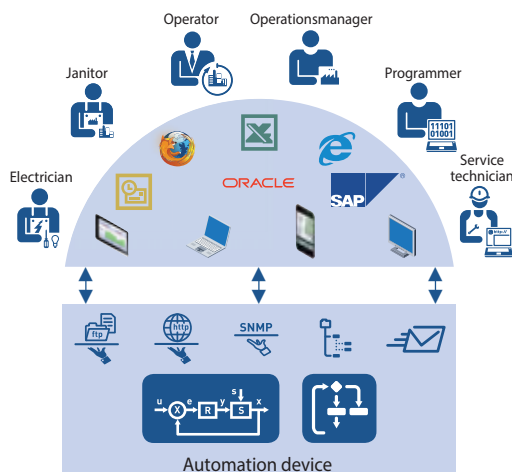

▲ Target group-oriented data output

### Components of the Automation Server



#### Web server:

System and process visualizations are implemented in the form of websites and can be accessed from the web server using browsers such as Internet Explorer, Firefox, etc.



#### File system:

Process data, records, etc. are stored in easy-to-use files. Standard formats allow problem-free subsequent processing, e.g. with Microsoft Excel.



#### FTP server:

Load files into the automation device over the network using FTP or export files from it.



#### E-mail:

Send critical system statuses and alarms, and log data via e-mail.



#### SNMP:

Transmit messages and alarms in an IT-compliant manner. Access to automation data using the IT management system.

... SNTP, DHCP, DNS ...

## Memory management in the Saia PCD® systems

Various data types may be found in a user program. These include pieces of data that are relevant for a fast regulation process, as well as data records that have to be collected over a long period or permanently saved. All these types of data have different requirements as far as the hardware is concerned.

For example, a regulation-relevant process requires fast memory in order to calculate and provide current values.

However, historical data records require sufficient remanent mass memory to cover a long time period.

If a user program function is placed in PG5, various memory areas are required in the system. Essentially, these areas can be divided into 3 groups. The parameter group controls the behavior of the FBox that is processed in the user program. Defined statuses of the parameters result in responses in the FBox. Taking the example of the HDLog function, the log data of the associated parameters is written to the file system in an Excel-compatible file format. Various templates are provided in the Web Editor to visualize this file in the web application.

These can be easily connected with the FBox with the help of parameters. As the visualization pages only change when the Saia PG5® is created, these are stored in the file system.

### Memory areas of the Saia PCD® systems

A distinction is made between 2 key memory areas.

The user memory (RAM), which ensures fast access for reading and writing, contains time-critical content such as media and the program code executed by the CPU. However, this memory is not a programmable read-only memory (PROM) and is buffered by a battery. The flash memory, on the other hand, permanently saves data and provides space for historical data records or data that will not change again during the operation of the system. The backup of the user application can be stored in a file system. This guarantees the processing of the program.

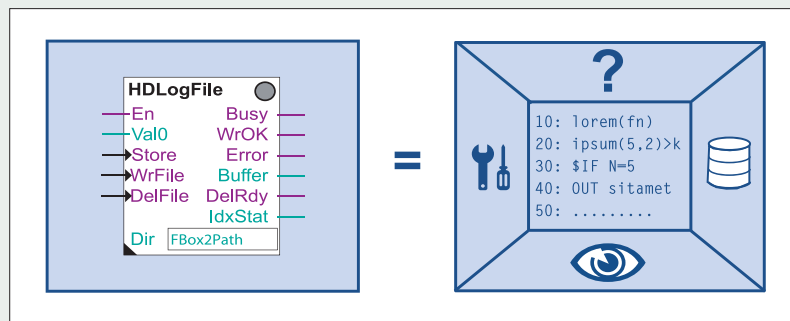

▲ Saia PG5® FBox shown as an object in the Saia PG5® Fupla engineering environment. To the right of this, you can see which functions belong to the object.

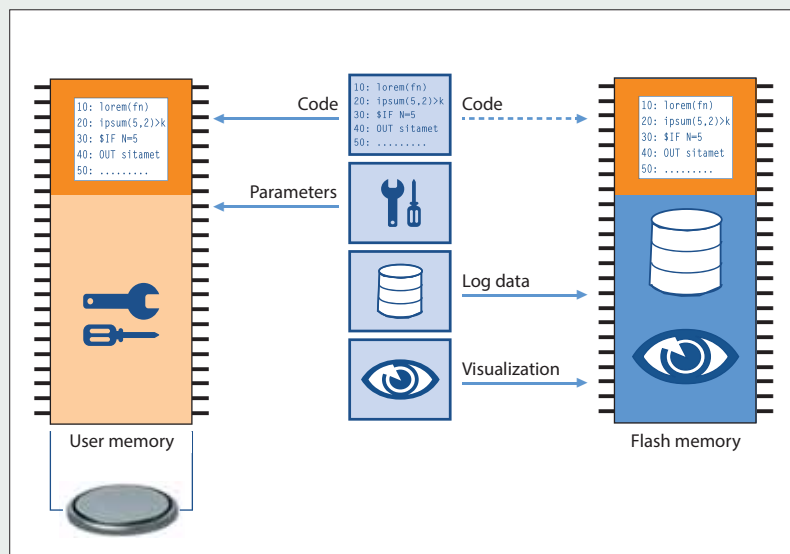

▲ This is how the functions of a [...] belonging to the Saia PG5® FBox are mapped in the memory areas



## Memory management of the Saia PCD® systems with COSinus operating system

### Automation devices with integrated uSD card

The automation devices Saia PCD3 Plus, Saia PCD1.M2 and the programmable panel are provided with an on-board uSD flash card. When loading a user application with Saia PG5®, all the necessary files in the internal flash memory are stored on the uSD card. If the operating voltage is connected to the automation device and there is no executable program in the user memory, COSinus attempts to load a valid program from the uSD card on startup.



Saia PCD1.M2xxx

Saia PCD3.Mxx6x

Saia PCD7.D4xxVT5F

### Automation devices without integrated on-board flash

In the case of automation devices without an integrated uSD card that are fitted with the COSinus system, the user application is copied directly to the user memory from Saia PG5®. If when the controller is started up no valid program is detected in the user program, a search is run for a backup program in the on-board flash or an optional memory module.



Saia PCD2.M554x

Saia PCD3.Mxx4x

Saia PCD3.M3xxx

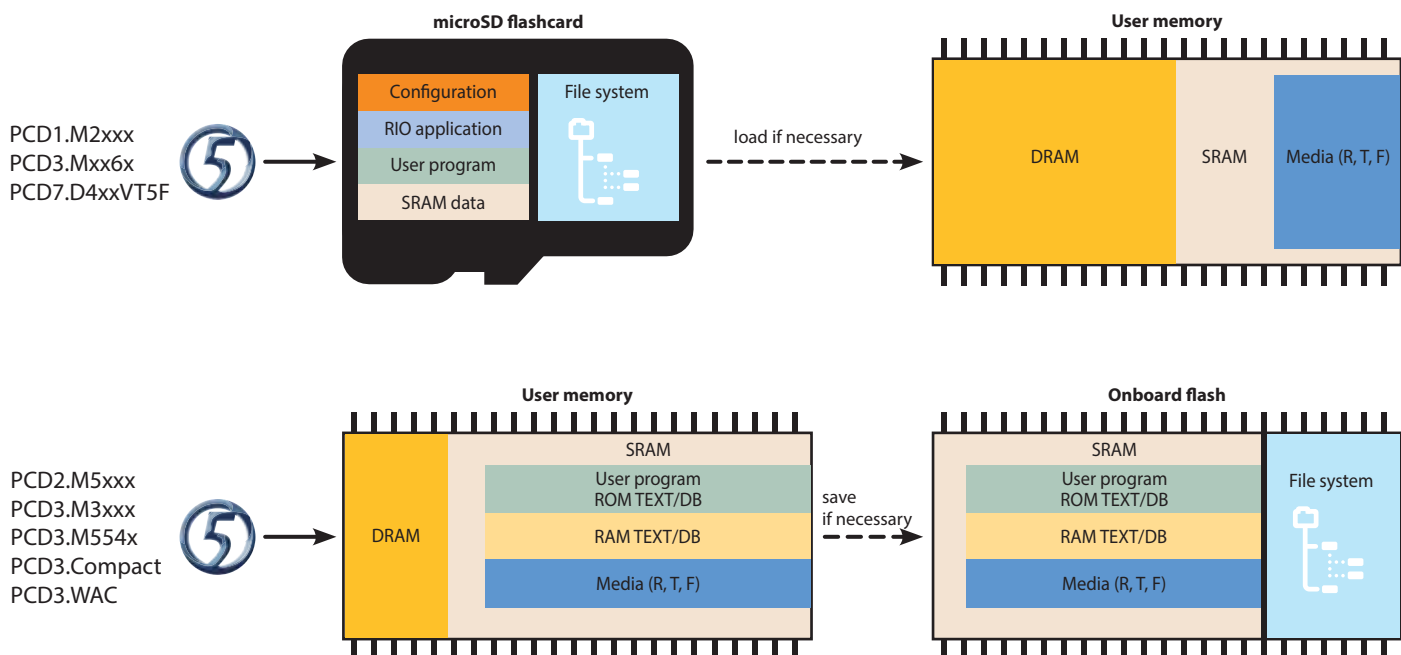
Saia PCD3.Compact  
Saia PCD3.Wide Area Controller

▲ Loading of the user program from Saia PG5® onto Saia PCD® automation devices and division of different data between the storage media.

# Memory extension and resources of the Saia PCD® systems

## Memory division of PCD1.M2xx0

### User memory

- ▶ User program: 512 kbytes–1 Mbyte
- ▶ DB/text: 128 kbytes–1 Mbyte

### Flash memory

- ▶ File system 8–128 Mbytes(maximum of 900–2,500 files or 225–625 directories)

### Flash memory extensions

- ▶ 1 extension module



## Memory division of PCD3.Mxx6x

### User memory

- ▶ User program: 2 Mbytes
- ▶ DB/text: 1 Mbyte

### Flash memory

- ▶ File system 128 Mbytes (maximum of 2,500 files or 625 directories)

### Flash memory extensions

- ▶ 4 extension modules



## Memory division of PCD3.Mxxxx

### User memory

- ▶ User program and DB/text 1024 kbytes

### Flash memory

- ▶ Backup memory 1024 kbytes

### Flash memory extensions

- ▶ 4 extension modules



## Memory division of PCD2.M5xx0

### User memory

- ▶ User program and DB/text 1024 kbytes

### Flash memory

- ▶ Backup memory 1024 kbytes

### Flash memory extensions

- ▶ 4 extension modules



## The system backup – entire automation project

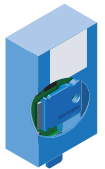
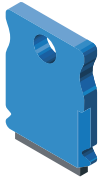

The application's system backup contains all the vital information and data that must be available in order to process the application. This enables the user to easily and safely reset his controller to a saved and known state. With the system backup function of the Saia PCD® COSinus operating system, it is also possible to fully duplicate a system and copy it to an identical piece of hardware – without any further adjustments (copy/paste). The system backup can be created in the office on a Saia PCD® memory module using an automation device of identical construction. Any technician (without training, a manual or software tools) can then perform a system restore or a system update in the event of changes directly on site.

### Creating a system backup

A system backup can also be created by the license-free Saia PG5® software tool "Online Configurator".

The system can be backed up on either the internal flash memory module or an optional memory module Saia PCD7.Rxxx.

### Using a system backup

No dedicated software tools are required to restore a system backup. All that is needed is an optional Saia PCD7.Rxxx memory module that contains a system backup for the target controller.

In order to restore the application contained in the backup memory module, you should press and hold the run/stop button for 3 seconds. The COSinus operating system automatically looks for a system backup of the application in all the storage media connected to the automation device.

If a valid system backup of the operating system is found, it is "automatically" loaded into the user memory. The automation device restarts.

▲ Memory media for external backups

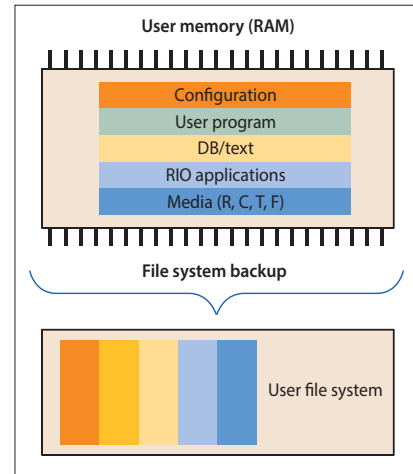

▲ Content of a system backup, created on an external module with a file system

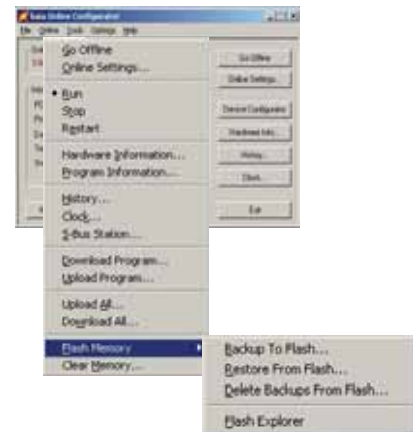

▲ Creation of a system backup with the Online Configurator

## Extension options of the user file system

Saia PCD® systems can be expanded with at least 1 to a maximum of 4 external memory modules that contain a user file system. An external file system is ideally suited as a backup for the entire user application and makes it possible to save trend data, alarms and event lists, as well as log files defined by the user. An external file system may contain up to 900 files or 225 directories.

### PCD3.R600 and PCD2.R6000

Module holder for SD flash memory cards with 512 and 1024 MB



### PCD7.R-SD512

SD flash memory cards with 512 MB

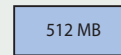

### PCD7.R-SD1024

SD flash memory cards with 1024 MB

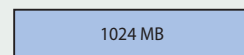

### PCD7.R582 Lon over IP

128 MB for file system and firmware extension for Lon over IP with Lon configuration files

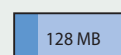

### PCD7.R562 BACnet®

128 MB for file system and firmware extension for BACnet® configuration files with BACnet® applications

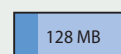

## FAQs for the design of automation systems



### Can third-party local I/Os be connected via S-Bus?

We exclude connecting these in the manual for the Saia PCD® controllers. SBC S-Bus is a proprietary protocol that is essentially designed for communication with engineering and debugging tools, for the connection of the management level or process control systems, and for PCD to PCD communication. It is not suitable for and nor is it approved for the connection of local I/Os from different manufacturers. I/Os from third-party manufacturers should be integrated professionally and safely using one of the many manufacturer-independent field bus systems.

### May the Saia PCD controllers directly connected to the internet?

When Saia PCD controllers are connected directly to the internet, they are also a potential target of cyber attacks. For secure operation, appropriate protective measures must always be taken. PCD controllers include simple, built-in protection features. However, secure operation on the internet is only ensured if external routers are used with a firewall and encrypted VPN connections.

For more information, please refer to our support site: [www.sbc-support.com/security](http://www.sbc-support.com/security)

### How do I connect a third-party device to the PCD if the protocol is not supported in the PCD firmware and there is not a corresponding FBox library either?

One of the greatest strengths of the Saia PCD® is that, in addition to the numerous communication protocols that exist "off the shelf", the user has the option of implementing any protocol he chooses in the user program himself. This is possible via a serial interface and also via Ethernet.

You can find PG5 example programs on our support site on this subject.

### What is the difference between local and remote I/Os?

When remote I/Os are accessed, a communications task always has to run. This task interrupts processing of the actual ICA task, thus extending the cycle time (page 11). If cycle time is important and critical, local I/Os are to be preferred.

### How many central I/Os per Saia PCD®?

The I/O capacity of a Saia PCD® automation station depends on the maximum number of pluggable I/O modules, i.e. 64 modules for the Saia PCD2 and Saia PCD3 series. Each module requires 16 bits. This gives a maximum of 1024 binary signals overall. Each Saia PCD® CPU in this system catalogue can read all 1024 binary signals in less than 10 msec and provide them to the user program logic. For calculation purposes, one can assume a value of 0.01 msec per binary I/O and 0.03 msec per analog value.

In practice, the number of I/Os is limited by the cycle time required for the user program (see explanation page 11). If the Saia PG5® IL-Editor is used to write a resource-efficient user program in text form, the 64 I/O slots of the Saia PCD® automation station will be fully usable. Cycle time will certainly be well below 100 msec.

If the application software is created using the Saia PG5® Fupla graphical software engineering tool with ready-made system templates (Saia PG5® DDC Suite), only half of the 64 possible I/O modules should be fitted for a cycle time < 100 msec. Additional communication and data processing tasks will further increase cycle time.

In the case of fully graphical software engineering for control-intensive applications combined with additional tasks (eg BACnet® gateway management functions), it is advisable not to use more than 300 I/Os per automation station.

### How does communication influence the application's cycle time?

If the PCD is set as server (master station), it has little to no control over its partner stations. Should these partner stations send large amounts of data simultaneously, the PCD MUST receive them. The receiving/processing of these data packages takes priority over the application's cycle time. Depending upon the workload, the cycle time may, as a consequence, be increased. Should several partner stations send large amounts of data at the same time, the PCD's processing time may be massively increased.

If the PCD is set as client (slave station), the impact is then minimal.

The figures below are based on a PCD3.M5340 with a program cycle time of 100 ms, excluding additional communication.

**Web server:** Displaying a page on a Micro-Browser panel or PC does not have a major impact. Loading a large file such as a Java applet or an offline trend during the transfer can increase cycle time by 40–50%. The same applies when large files are transferred via FTP.

**S-Bus or Modbus communication via Ethernet:** Each partner station running under full load increases the cycle time by approximately 8%.

**Serial S-Bus:** Each slave-type communication at 38.4 kbit/s increases cycle time by 5% (port #2). On PCDx.F2xx modules the increase is about 17%.

At 115 Kbit/s the cycle time is approximately 20% higher.

**Modbus RTU:** A client at 115 kbit/s increases cycle time by about 11% (port #2). On PCDx.F2xx modules the increase is up to 45%.

### What exactly does MTBF mean? Where can I find the MTBF values for Saia PCD® controllers?

MTBF is the abbreviation for Mean Time Between Failures. The time referred to is the period of operation between two consecutive failures of a unit (module, device or system). The higher the MTBF value, the more "reliable" the device. On average, a device with a MTBF of 100 hours will fail more often than a similar device with a MTBF of 1,000 hours. The MTBF can be calculated in purely mathematical terms or on the basis of empirical values. Please bear in mind that the MTBF value of the overall installation is dependent on the values of the individual switch cabinet components.

You can find an overview of the MTBF values of the PCD controllers on our support site.

The rate of returns is more relevant in practice. We analyze all the devices that come back from the field. The return rates of the current PCD controllers during the warranty period (30 months) are as follows:

PCD2.M5xxx:	0.94%
PCD3.M5xxx:	0.99%
PCD3.M3xxx:	1.14%

### What part of the memory is lost if the battery fails and how does the PDC react?

In theory, the user memory of the PCD, which contains the content of the media such as registers, counters, meters and flags, as well as the writable part of the DB and text elements, is lost in the event of a failure of the power supply with a battery that is additionally weak or defective. We now have to differentiate between two different types of PCDs.

Controllers that are equipped with an internal microSD card, store the user program and associated initial values of the media in a system partition. In the event of the user memory without backup being lost, this data is reloaded into the user memory and the program is processed again with the parameters that were defined at the time of the download in PG5.

Controllers that do not have an internal file system need a backup containing the user program and associated media. This backup can be created with the help of PG5 when downloading the application. In order that it is possible to restore the program and the media content, in the case of empty memory, as a general rule, the last download of an application should be backed up to an external file system of the PCD.

If a backup of the application of a PCD is available and the content of the user memory is not plausible, the application will be restored from the point at which the backup was created.



## 1.2 Saia PCD3 series

### 1.2.1 Saia PCD3 controllers

#### Layout for the Saia PCD3 series

Page 20

**Description of the basic structure and general features of the modular Saia PCD3 series**

#### Saia PCD3.Mxxxx controllers

Page 22



##### Base units with 4 slots for I/O modules

- ▶ PCD3.Mxx60 High Power CPU
- ▶ PCD3.M5xxx Standard CPU
- ▶ PCD3.M3xxx Minimum Basic CPU

Up to 5 integrated communication interfaces, can be extended to max. 13 communication interfaces with plug-in modules. Integrated Automation Server in all CPUs.

#### Saia PCD3.Cxxx module holder for I/O expansion

Page 21



##### Module holder for I/O modules

- ▶ PCD3.C100 4 I/O slots
- ▶ PCD3.C110 2 I/O slots
- ▶ PCD3.C200 4 I/O slots with 24 VDC power supply

Expansion to max. 1,023 I/Os

#### Saia PCD3 input/output modules in cassette design

Page 26



##### Modules with various functions with plug-in terminals

- ▶ PCD3.Axxx Digital output modules
- ▶ PCD3.Bxxx Digital combined input/output modules
- ▶ PCD3.Exxx Digital input modules
- ▶ PCD3.Wxxx Analog input/output modules

#### Saia PCD3 interface modules

Page 31



##### Plug-in modules to extend the communication interfaces

(up to 4 modules or 8 interfaces)

- ▶ PCD3.F1xx 1 serial interface RS-232, RS-422/485
- ▶ PCD3.F2xx 2 serial interfaces RS-232, RS-422/RS-485
- ▶ PCD3.F215 BACnet® MSTP
- ▶ PCD3.F26x DALI
- ▶ PCD3.F27x M-Bus
- ▶ PCD3.F28x Belimo MP-Bus

#### Saia PCD3 memory modules

Page 32



##### Plug-in memory modules for data and program backup

- ▶ PCD3.R5xx Flash memory module for slots 0...3
- ▶ PCD3.R6xx Basic module for SD flashcard for slots 0...3
- ▶ PCD7.R-SD SD flashcards for PCD3.R6xx
- ▶ PCD7.R5xx Flash memory module for slots M1 and M2

#### Consumables and accessories for Saia PCD3 controllers

Page 33



**Batteries, terminals, system cables, labeling accessories...**

## Layout for Saia PCD3 controllers

The CPU has been incorporated in the back-plate of the device, unlike comparable systems. Its capacity can be increased individually with plug-in communication modules and/or intelligent I/O modules. These have a direct, very fast bus connection to the CPU.



### PCD3.Mxxxx base unit

Base unit with CPU and 4 slots for I/O modules, communication or other specific modules (e.g. PCD3.Hxxx counting module)

#### Layout

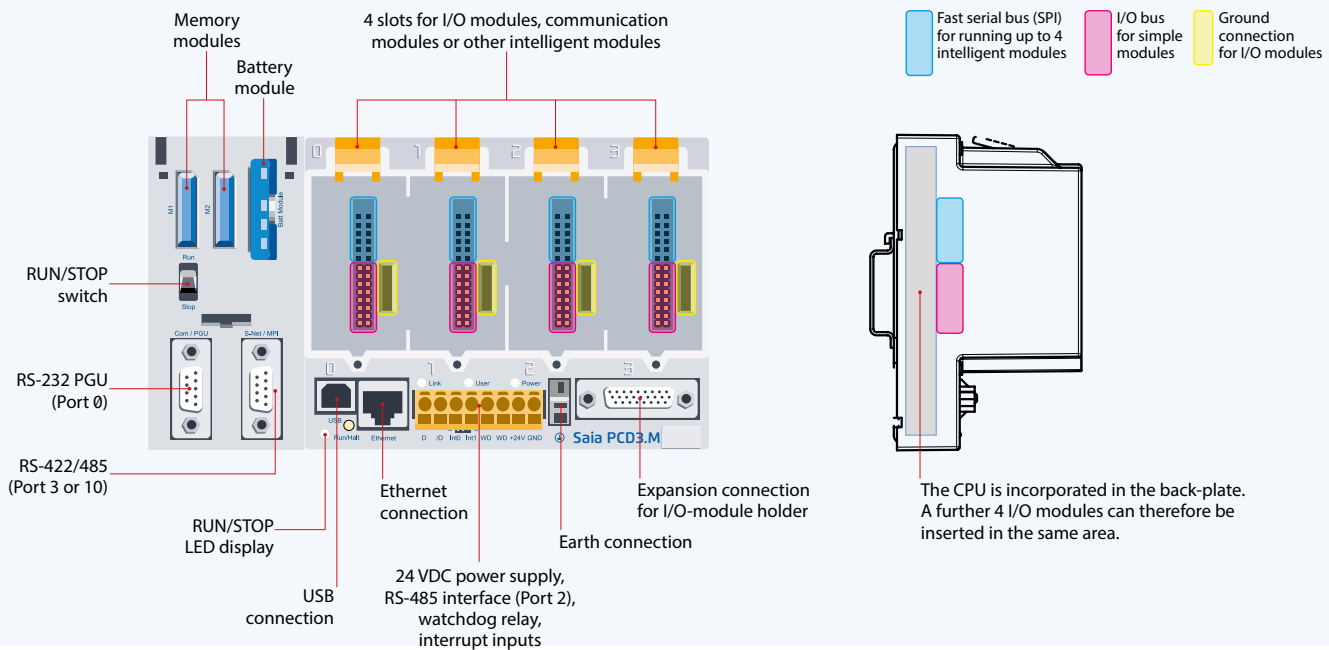

With the left expansion, the Standard (PCD3.M5/M6xxx) and High Power (PCD3.Mxx60) CPU types have slots for a battery holder module with LED displays, a run/stop switch, two slots for flash memory modules and two further communication interfaces. The LED displays on the battery module indicate the status of the CPU and battery and any errors in the application. The battery also protects the data in the event of the supply voltage being interrupted. It can be replaced while under power during operation. The configuration, programs and data can be transferred from one controller to another using the plug-in flash memory modules. No programming tool is required for this.

#### Dimensions

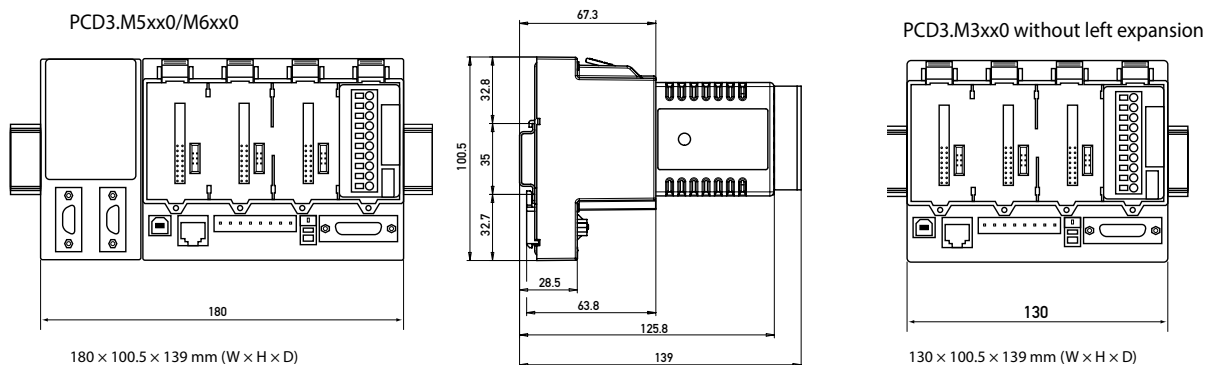

▲ Standard and High Power CPU with slots for battery and memory modules, run/stop switch and additional interfaces

▶ Minimum Basic CPU without battery module  
PCD3.Rxxx memory modules are plugged into an I/O slot.

# Saia PCD3.Cxxx module holder

I/O expansion module holders are available in either a 2 or 4 slot version. They can be expanded to a maximum of 64 I/O modules or a maximum of 1,203 I/Os.



## Layout Module holder

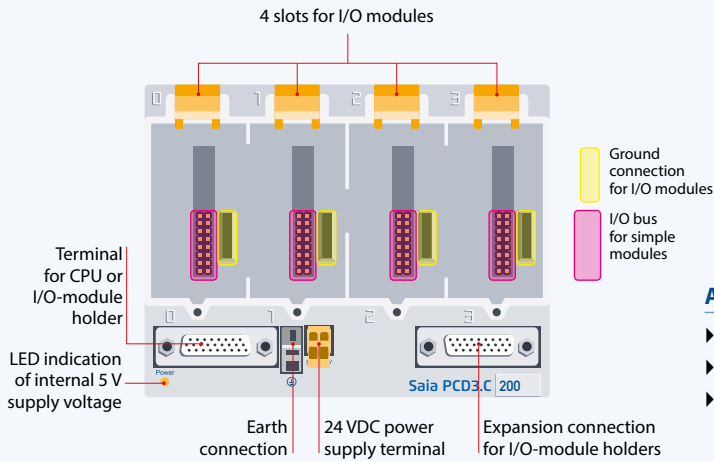

All standard I/O-modules can be used in the expansion module holders. Communication modules or other intelligent modules can only be used in the slots of the Basic CPU.

### Available types

- ▶ **PCD3.C100** Expansion module holder with 4 I/O slots
- ▶ **PCD3.C110** Expansion module holder with 2 I/O slots
- ▶ **PCD3.C200** Expansion module holder with 4 I/O slots and terminal connectors for 24 VDC power supply for all connected I/O modules, plus any downstream PCD3.C1xx module holders

**PCD3.C100/200**  
with 4 I/O slots

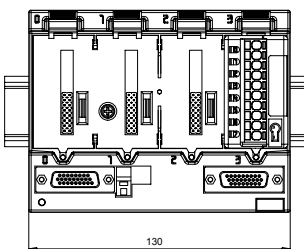

**PCD3.C110**  
with 2 I/O slots

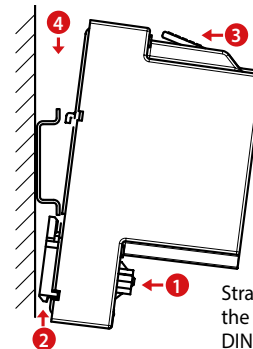
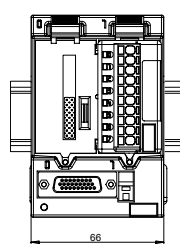

Straightforward mounting of the CPUs and module holders on DIN top-hat rail (1 x 35 mm)

## System can be expanded to max. 1,023 I/Os

Single-row and multiple-row mounting of the module holders

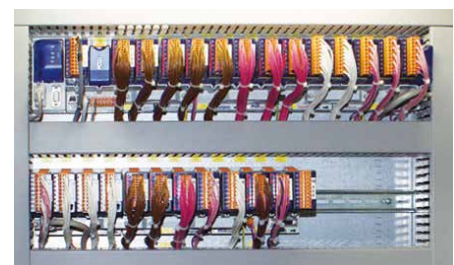
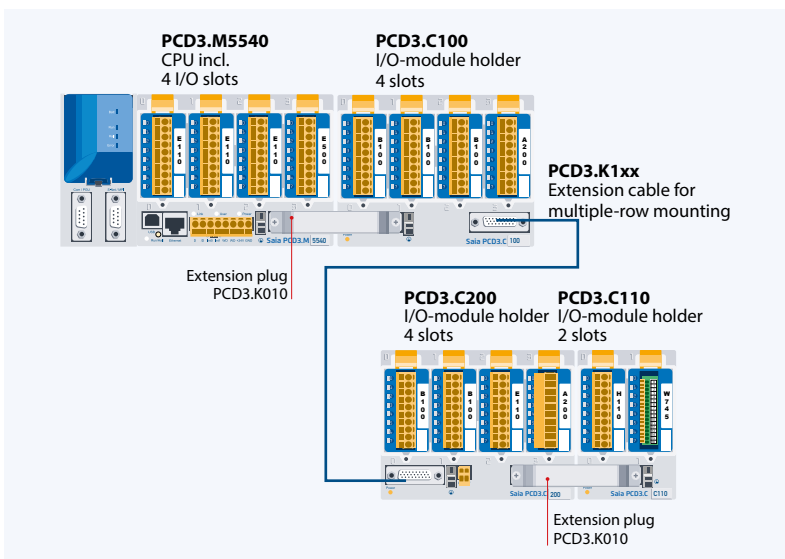

PCD3 in multiple-row mounting in the switch cabinet

### Extension plug and cables

- ▶ **PCD3.K010** Extension plug
- ▶ **PCD3.K106** Extension cable 0.7 m
- ▶ **PCD3.K116** Extension cable 1.2 m

## Saia PCD3.Mxx60 controllers

### High Power CPU for all requirements

Thanks to the fast processor and the increased system resources, the Power CPU has sufficient power reserves to process the most demanding control and communication tasks.



#### System properties

- ▶ Up to 1'023 inputs/outputs  
Can be expanded locally with RIO PCD3.T66x or PCD3.T76x
- ▶ Up to 13 communication interfaces
- ▶ USB and Ethernet interface onboard
- ▶ 2 Ethernet interfaces (PCD3.M6860 only)
- ▶ Fast program processing (0.1µs for bit operations)
- ▶ Large onboard memory for programs (2 MByte) and data (128 MByte file system)
- ▶ Memory with SD flashcards can be expanded to 4 GByte
- ▶ Automation Server for the integration into Web/IT systems



#### Types

- ▶ **PCD3.M5560** CPU basic module with Ethernet TCP/IP, 2 MByte of program memory
- ▶ **PCD3.M6560** CPU basic module with Ethernet TCP/IP and Profibus-DP Master 12 Mbit/s, 2 MByte of program memory
- ▶ **PCD3.M6860** CPU basic module with 2 × Ethernet TCP/IP, 2 MByte of program memory

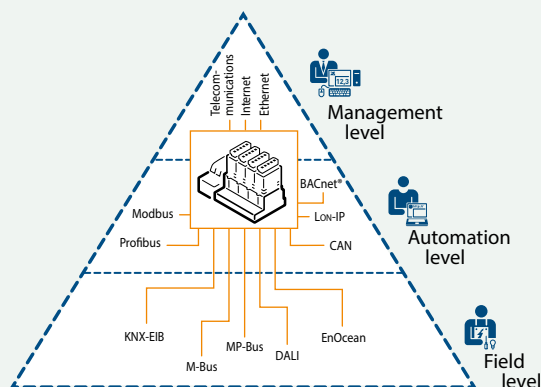

- ▶ The Saia PCD3 Power CPU has sufficient system resources to operate up to 13 communication interfaces in the same device. Even the most demanding tasks, such as simultaneous communication via BACnet® and LON IP, are handled reliably.

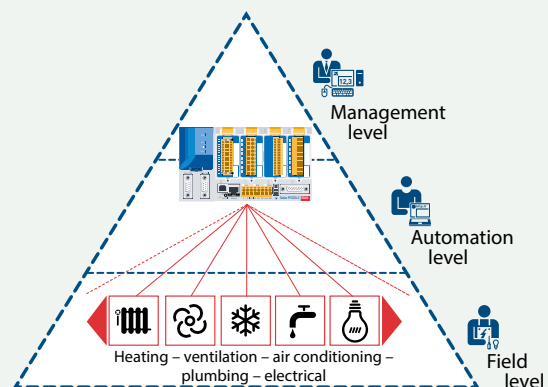

- ▶ The generous memory resources (4 GByte) of the new PCD3 Power CPU make it possible to record/monitor, archive and control the data and statuses of all trades in the Saia PCD®, even without computer equipment and control system software. Applications for the various subsystems (HVAC) can be conveniently created using the graphical PG5 engineering tool and application-specific software libraries.

## Saia PCD3.Mxx60 controllers

### High Power CPU

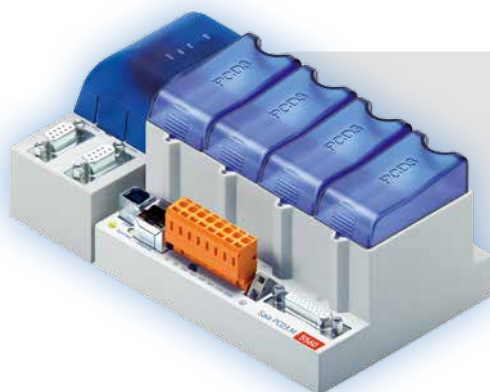

1,023	I/O
4.2 GByte	File system
2 MByte	Program
0.1/0.3 μs bit/word	CPU speed

#### Technical data

	PCD3.M5560	PCD3.M6560	PCD3.M6860
	Power	Power DP Master	Power 2 × Ethernet
Number of inputs/outputs or I/O-module slots		1023	
I/O expansion connection for PCD3.C module holder		Yes	
Processing time [μs]	bit operation	0.1...0.8 μs	
	word operation	0.3 μs	
Real time clock (RTC)		Yes	

#### On-Board memory

Program memory, DB/text (ROM)	2 MByte
User memory, DB/text (RAM)	1 MByte
Flash memory (S-RIO, configuration and backup)	128 MByte
User flash file system (INTFLASH)	128 MByte
Data backup	1...3 years with lithium battery

#### On-Board interfaces

USB 1.1	Yes		
Ethernet 10/100 Mbit/s, full-duplex, auto-sensing/auto-crossing	Yes		2×
RS-232 on D-Sub connector (PGU/Port 0)	up to 115 kbit/s		No
RS-485 on terminal block (Port 2) or RS-485 Profibus-DP Slave, Profi-S-Net on terminal block (Port 2)	up to 115 kbit/s No	up to 115 kbit/s up to 187.5 kbit/s	up to 115 kbit/s up to 187.5 kbit/s
RS-485 on D-Sub connector (Port 3) * or Profibus-DP Slave, Profi-S-Net on D-Sub connector (Port 10) * or Profibus-DP Master up to 12 Mbit/s on D-Sub connector (Port 10) *	up to 115 kbit/s up to 1.5 Mbit/s No	No No Yes	No No No

\* can be used as an alternative, electrically isolated

#### Options

The data memory can be extended with flash memory modules (with file system) up to 4 GByte.

#### Optional data interfaces

I/O slot 0	PCD3.F1xx modules for RS-232, RS-422, RS-485 and Belimo MP-Bus
I/O slot 0...3 up to 4 modules or 8 interfaces	PCD3.F2xx modules for RS-232, RS-422, RS-485, BACnet® MS/TP, Belimo MP-Bus, DALI and M-Bus

#### General data

Supply voltage (according to EN/IEC 61131-2)	24 VDC -20/+25% max. incl. 5% ripple or 19 VAC +/-15% full-wave rectified (18 VDC)
Power consumption	typically 15 W for 64 I/Os
Capacity 5 V/+V (24 V) internal	max. 600 mA/100 mA

## Saia PCD3.M5x40 controllers

### Standard CPU for a large number of applications

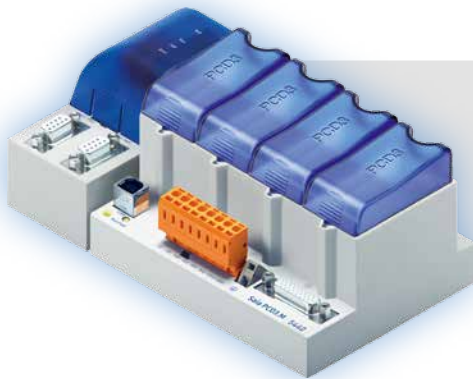

1,023	I/O
4 GByte	File system
1 MByte	Program
0.3/0.9 $\mu$ s bit/word	CPU speed

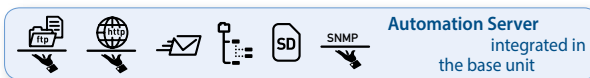

#### Types

- ▶ **PCD3.M5340** CPU basic module with Ethernet TCP/IP, 1 MByte of program memory
- ▶ **PCD3.M5440** CPU basic module without Ethernet TCP/IP, 1 MByte of program memory
- ▶ **PCD3.M5540** CPU basic module with Ethernet TCP/IP and Profibus-DP Slave 1.5 Mbit/s, 1 MByte of program memory

#### Technical data

	PCD3.M5340	PCD3.M5440	PCD3.M5540
	Standard	Standard	Standard
Number of inputs/outputs or I/O-module slots		1,023	64
I/O expansion connection for PCD3.Cxxx module holder		Yes	
Processing times [ $\mu$ s]	bit operation	0.3 ... 1.5 $\mu$ s	
	word operation	0.9 $\mu$ s	
Real time clock (RTC)		Yes	

#### On-Board memory

Main memory (RAM) for program and DB/text	1 MByte
Flash memory (S-RIO, configuration and backup)	2 MByte
User flash file system (INTFLASH)	No
Data backup	1 ... 3 years with lithium battery

#### On-Board interfaces

USB 1.1		Yes	
Ethernet 10/100 Mbit/s, full-duplex, auto-sensing/auto-crossing	Yes	No	Yes
RS-232 on D-Sub connector (PGU/Port 0)		up to 115 kbit/s	
RS-485 on terminal block (Port 2) or RS-485 Profibus-DP Slave, Profi-S-Net on terminal block (Port 2)	up to 115 kbit/s up to 187.5 kbit/s	up to 115 kbit/s No	up to 115 kbit/s No
RS-422/485 (electrically connected) on D-Sub connector (Port 3) *	up to 115 kbit/s	No	No
RS-485 (electrically separated) on D-Sub connector (Port 3) *	No	up to 115 kbit/s	up to 115 kbit/s
Profibus-DP Slave, Profi-S-Net on D-Sub connector (Port 10) *	No	up to 1.5 Mbit/s	up to 1.5 Mbit/s

\* can be used as an alternative

#### Options

The data memory can be expanded to 4 GByte with flash memory modules (with file system).

#### Optional data interfaces

I/O slot 0	PCD3.F1xx modules for RS-232, RS-422, RS-485 and Belimo MP-Bus
I/O slot 0 ... 3 up to 4 modules or 8 interfaces	PCD3.F2xx modules for RS-232, RS-422, RS-485, BACnet® MS/TP, Belimo MP-Bus, DALI and M-Bus

#### General data

Supply voltage (according to EN/IEC 61131-2)	24 VDC -20/+25% max. incl. 5% ripple or 19 VAC +/-15% full-wave rectified (18 VDC)
Power consumption	typically 15 W for 64 I/Os
Capacity 5V/+V (24V) internal	max. 600 mA/100 mA



## Saia PCD3.M3xx0 controllers

### Basic CPU for simple applications

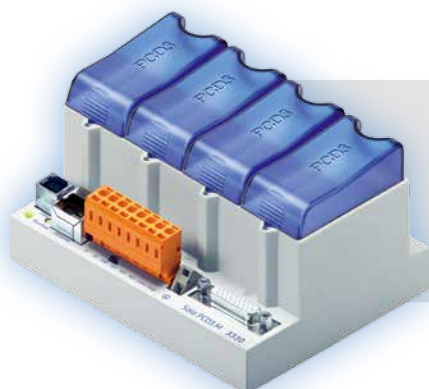

1,023	I/O
4 GByte	File system
512 kByte	Program
0.3/0.9 $\mu$ s bit/word	CPU speed

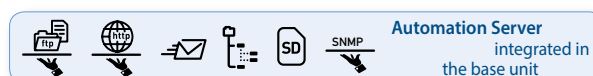

#### Types

- **PCD3.M3120** CPU basic module with Ethernet TCP/IP, 64 I/Os, 128 kByte of program memory
- **PCD3.M3230** CPU basic module without Ethernet TCP/IP, 1,023 I/Os, 512 kByte of program memory
- **PCD3.M3330** CPU basic module with Ethernet TCP/IP, 1,023 I/Os, 512 kByte of program memory

#### Technical data

	PCD3.M3120	PCD3.M3230	PCD3.M3330
	Basic	Basic	Basic
Number of inputs/outputs	64	1,023	1,023
or I/O-module slots	4	64	64
I/O expansion connection for PCD3.Cxxx module holder	No	Yes	Yes
Processing times [ $\mu$ s]	bit operation	0.3...1.5 $\mu$ s	
	word operation	0.9 $\mu$ s	
Real time clock (RTC)		Yes	

#### On-Board memory

	PCD3.M3120	PCD3.M3230	PCD3.M3330
Main memory (RAM) for program and DB/text	128 kByte	512 kByte	512 kByte
Flash memory (S-RIO, configuration and backup)	2 MByte		
User flash file system (INTFLASH)	No		
Data backup	4 hours with SuperCap		

#### On-Board interfaces

	PCD3.M3120	PCD3.M3230	PCD3.M3330
USB 1.1		Yes	
Ethernet 10/100 Mbit/s, full-duplex, auto-sensing/auto-crossing	Yes	No	Yes
RS-485 on terminal block (Port 2) or RS-485 Profibus-DP Slave, Profi-S-Net on terminal block (Port 2)		up to 115 kbit/s up to 187.5 kbit/s	

#### Options

The data memory can be expanded to 4 GByte with flash memory modules (with file system).

#### Optional data interfaces

I/O slot 0	PCD3.F1xx modules for RS-232, RS-422, RS-485 and Belimo MP-Bus
I/O slot 0...3 up to 4 modules or 8 interfaces	PCD3.F2xx modules for RS-232, RS-422, RS-485, BACnet® MS/TP, Belimo MP-Bus, DALI and M-Bus

#### General data

Supply voltage (according to EN/IEC61131-2)	24 VDC $-20/+25\%$ max. incl. 5% ripple or 19 VAC $+/-15\%$ full-wave rectified (18 VDC)
Power consumption	typically 15 W for 64 I/Os
Capacity 5V/+V (24V) internal	max. 600 mA/100 mA



## Saia PCD3 input and output modules in cassette design

The functions of the Saia PCD3 can be expanded as required using a wide range of plug-in I/O modules and can be adapted to specified needs. This not only ensures that a project can be implemented quickly but also provides the option of expanding or modifying the system at any time.

### System properties

- ▶ Numerous variants available
- ▶ Slot directly in the Saia PCD3 basic CPU or in the module holder
- ▶ Full integration into the Saia PCD3 housing
- ▶ Stable cassette design
- ▶ Connection to the I/O level via plug-in spring terminal blocks or ribbon cables and adapters
- ▶ I/O terminal blocks are supplied as standard
- ▶ No tools required for replacing modules

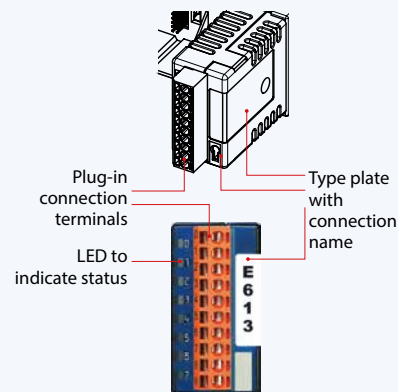

### Insertion of I/O modules

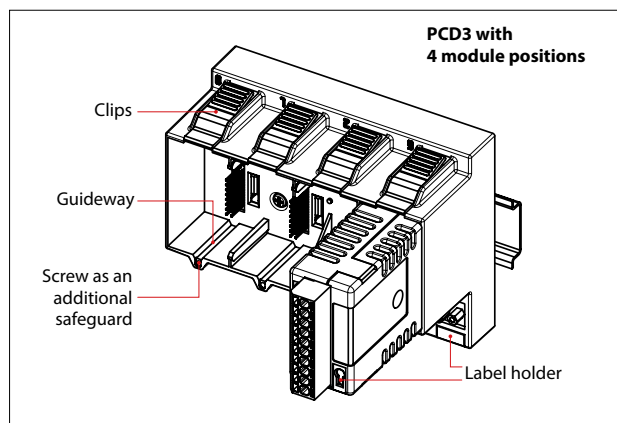

▲ Simple exchange of I/O modules

### More than 50 modules available with different functionalities

#### Types

- ▶ PCD3.Axxx Digital output modules
- ▶ PCD3.Bxxx Digital combined input/output modules
- ▶ PCD3.Exxx Digital input modules
- ▶ PCD3.Fxxx Communication modules
- ▶ PCD3.Hxxx Fast counter modules
- ▶ PCD3.Rxxx Memory modules
- ▶ PCD3.Wxxx Analog input/output modules

### Connecting plugs/terminals

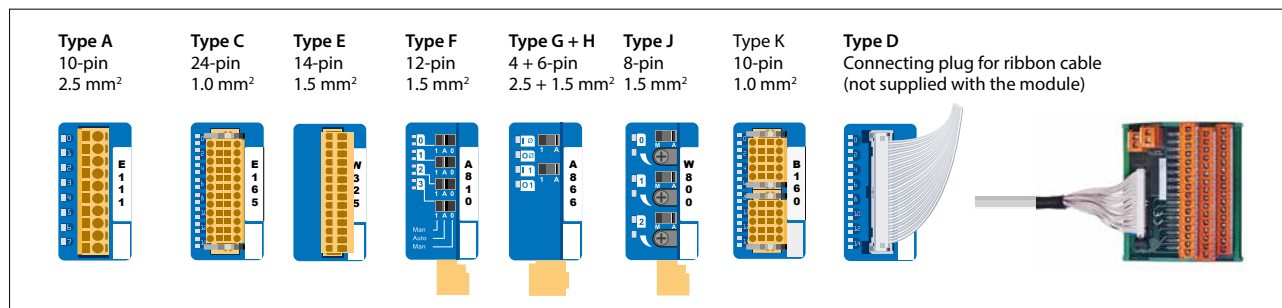

▲ Spare terminals, ribbon connectors with system cables and separate terminals are ordered as accessories.

## Saia PCD3 Digital input and output modules

The digital I/O modules can be easily plugged into the Saia PCD3 Basis CPU or an appropriate module holder. In addition to inputs for various voltage levels, digital outputs are provided with both the transistor technology and as mechanical relays. This means that electrical isolation from the switching electrical circuit can be achieved easily and reliably.

### Digital input modules

Type	Number of I/Os	Input voltage	Output breaking capacity		Input delay	Electrical isolation	Internal current draw		I/O connector type <sup>3)</sup>
			DC	AC			5 V bus <sup>1)</sup>	+ V bus <sup>2)</sup>	
PCD3.E110	8 I	15...30 VDC			8 ms		24 mA		A
PCD3.E111	8 I	15...30 VDC	---	---	0.2 ms		24 mA		A
PCD3.E112	8 I	7.5...15 VDC			9 ms	---	24 mA	---	A
PCD3.E116	8 I	3.5...7 VDC			0.2 ms		24 mA		A
PCD3.E160	16 I	15...30 VDC	---	---	8 ms		10 mA	---	D
PCD3.E161	16 I	15...30 VDC			0.2 ms		10 mA		D
PCD3.E165	16 I	15...30 VDC	---	---	8 ms		10 mA	---	C
PCD3.E166	16 I	15...30 VDC			0.2 ms		10 mA		C
PCD3.E500	6 I	80...250 VAC	---	---	20 ms	•	1 mA	---	A
PCD3.E610	8 I	15...30 VDC	---	---	10 ms	•	24 mA	---	A
PCD3.E613	8 I	30...60 VDC	---	---	9 ms	•	24 mA	---	A

### Digital output modules

Type	Number of I/Os	Input voltage	Output breaking capacity		Input delay	Electrical isolation	Internal current draw		I/O connector type <sup>3)</sup>
			DC	AC			5 V bus <sup>1)</sup>	+ V bus <sup>2)</sup>	
PCD3.A200	4 O, relay (make)		2 A/50 VDC	2 A/250 VAC		•	15 mA		A
PCD3.A210	4 O, relay (break)	---	2 A/50 VDC	2 A/250 VAC	---	•	15 mA	---	A
PCD3.A220	6 O, relay (make)	---	2 A/50 VDC	2 A/250 VAC	---	•	20 mA	---	A
PCD3.A251	8 O, relay (6 changeover + 2 make)	---	2 A/50 VDC	2 A/48 VAC	---	•	25 mA	---	C
PCD3.A300	6 O, transistor	---	2 A/10...32 VDC	---	---	---	20 mA	---	A
PCD3.A400	8 O, transistor	---	0.5 A/5...32 VDC	---	---	---	25 mA	---	A
PCD3.A410	8 O, transistor	---	0.5 A/5...32 VDC	---	---	•	24 mA	---	A
PCD3.A460	16 O, transistor	---	0.5 A/10...32 VDC	---	---	---	10 mA	---	D
PCD3.A465	16 O, transistor	---	0.5 A/10...32 VDC	---	---	---	10 mA	---	C
PCD3.A810 Manual control	4 O, relay (2 changeover + 2 make)	---	2 A/50 VDC 2 A/50 VDC	5 A/250 VAC 6 A/250 VAC	---	• •	40 mA	---	F

### Digital input/output modules

Type	Number of I/Os	Input voltage	Output breaking capacity		Input delay	Electrical isolation	Internal current draw		I/O connector type <sup>3)</sup>
			DC	AC			5 V bus <sup>1)</sup>	+ V bus <sup>2)</sup>	
PCD3.A860 Light&shade	2 O, relay (make) 2 I	15...30 VDC	---	12 A/250 VAC	8 ms	•	18 mA	---	G H
PCD3.B100	2 I + 2 O + 4 selectable I or O	I: 15...32 VDC	0.5 A/5...32 VDC	---	8 ms	---	25 mA	---	A
PCD3.B160	16 I/O (configurable)	I: 24 VDC	0.25 A/18...30 VDC	---	8 ms or 0.2 ms	---	120 mA	---	2× K

### Fast counter modules (only for I/O slots with fast SPI bus)

Type	Number of counters	Inputs per counter	Outputs per counter	Counting range	Selectable digital filter	Current draw		I/O connector type <sup>3)</sup>
						5 V bus <sup>1)</sup>	+ V bus <sup>2)</sup>	
PCD3.H112 <sup>4)</sup>	2	2 I + 1 configurable I	1 CCO	0...16777215 (24-bit)	10 kHz...150 kHz	50 mA	4 mA	K
PCD3.H114 <sup>4)</sup>	4	2 I + 1 configurable I	1 CCO	0...16777215 (24-bit)	10 kHz...150 kHz	50 mA	4 mA	2× K

### Capacity of the internal bus (5V, +V) of the PCD3 controllers and module holders

Capacity	PCD3.Mxxx0	PCD3.Txxx	PCD3.C200
<sup>1)</sup> Internal 5V	600 mA	600 mA	1500 mA
<sup>2)</sup> Internal +V (24V)	100 mA	100 mA	200 mA

The electrical requirement of the internal +5V and +V bus for the I/O modules is calculated in the PG5 2.0 Device Configurator.

<sup>3)</sup> Plug-in I/O terminal blocks are included with I/O modules. Spare terminals, ribbon connectors with system cables and separate terminals are ordered as accessories (see page 34 and page 78).

<sup>4)</sup> Delivery on demand

## Saia PCD3 Analogue input and output modules

The numerous analogue modules allow complex control tasks or measurements. Depending on the speed of the AD converter, the resolution is between 8 and 16-bit. The digitized values can be processed further directly in the project in the Saia PCD3. The large number of different modules means that suitable modules can be found to cover nearly every requirement.

### Analogue input modules

Type	Total channels	Signal ranges/description	Resolution	Electrical isolation	Internal current draw		I/O connector type <sup>3)</sup>
					5 V bus <sup>1)</sup>	+V bus <sup>2)</sup>	
PCD3.W200	8 I	0...+10 V	10-bit	---	8 mA	5 mA	A
PCD3.W210	8 I	0...20 mA <sup>4)</sup>	10-bit		8 mA	5 mA	A
PCD3.W220	8 I	Pt 1000: -50°C...400°C/Ni 1000: -50°C...+200°C	10-bit		8 mA	16 mA	A
PCD3.W220Z03	8 I	NTC 10 temperature sensor	10-bit		8 mA	16 mA	A
PCD3.W220Z12	4 I +4 I	4 I: 0...10 V 4 I Pt 1000: -50°C...400°C/Ni 1000: -50°C...+200°C	10-bit		8 mA	11 mA	A
PCD3.W300	8 I	0...+10 V	12-bit	---	8 mA	5 mA	A
PCD3.W310	8 I	0...20 mA <sup>4)</sup>	12-bit		8 mA	5 mA	A
PCD3.W340	8 I	0...+10 V/0...20 mA <sup>4)</sup> Pt 1000: -50°C...400°C/Ni 1000: -50°C...+200°C	12-bit		8 mA	20 mA	A
PCD3.W350	8 I	Pt 100: -50°C...+600°C/Ni 100: -50°C...+250°C	12-bit		8 mA	30 mA	A
PCD3.W360	8 I	Pt 1000: -50°C...+150°C	12-bit		8 mA	20 mA	A
PCD3.W380	8 I	-10 V...+10 V, -20 mA...+20 mA, Pt/Ni1000, Ni1000 L&S, NTC10k/NTC20k (configuration via user program)	13-bit	25 mA	25 mA	2×K	
PCD3.W305	7 I	0...+10 V	12-bit	•	60 mA	0 mA	E
PCD3.W315	7 I	0...20 mA <sup>4)</sup>	12-bit	•	60 mA	0 mA	E
PCD3.W325	7 I	-10 V...+10 V	12-bit	•	60 mA	0 mA	E
PCD3.W720	2 I	Weighing module with 2 systems for up to 6 weighing cells	≤18 Bit	---	60 mA	100 mA	E
PCD3.W745	4 I	Temperature module for TC type J, K and 4-wire Pt/Ni 100/1000	16-bit	•	200 mA	0 mA	<sup>6)</sup>

### Analogue output modules

Type	Total channels	Signal ranges/description	Resolution	Electrical isolation	Internal current draw		I/O connector type <sup>3)</sup>
					5 V bus <sup>1)</sup>	+V bus <sup>2)</sup>	
PCD3.W400	4 O	0...+10 V	8-bit	---	1 mA	30 mA	A
PCD3.W410	4 O	0...+10 V/0...20 mA/4...20 mA jumper-selectable	8-bit		1 mA	30 mA	A
PCD3.W600	4 O	0...+10 V	12-bit	---	4 mA	20 mA	A
PCD3.W610	4 O	0...+10 V/-10 V...+10 V/0...20 mA/4...20 mA jumper-selectable	12-bit		110 mA	0 mA	A
PCD3.W605	6 O	0...+10 V	10-bit	•	110 mA	0 mA	E
PCD3.W615	4 O	0...20 mA/4...20 mA parameters can be set	10-bit	•	55 mA	0 mA	E
PCD3.W625	6 O	-10 V...+10 V	10-bit	•	110 mA	0 mA	E
PCD3.W800	4 O, 3 of which are manually operated	0...+10 V, short circuit proofed	10-bit	---	45 mA	35 mA <sup>5)</sup>	J

### Analogue input/output modules

Type	Total channels	Signal ranges/description	Resolution	Electrical isolation	Internal current draw		I/O connector type <sup>3)</sup>
					5 V bus <sup>1)</sup>	+V bus <sup>2)</sup>	
PCD3.W525	4 I + 2 O	I: 0...10 V, 0(4)...20 mA, Pt 1000, Pt 500 or Ni 1000 (selectable by DIP switch) O: 0...10 V or 0(4)...20 mA (selectable by software)	I: 14-bit O: 12-bit	•	40 mA	0 mA	E

### Manual control modules

#### PCD3.A810

Relay outputs, 2 changeover and 2 make contacts



#### PCD3.A860

Light and shade 2 relay outputs and 2 inputs



#### PCD3.W800

4 analog outputs (3 channels with manual control)



### Capacity of the internal bus (5V, +V) of the PCD3 controllers and module holders

Capacity	PCD3.Mxxx0	PCD3.Txxx	PCD3.C200
<sup>1)</sup> Internal 5 V	600 mA	600 mA	1500 mA
<sup>2)</sup> Internal +V (24 V)	100 mA	100 mA	200 mA

The electrical requirement of the internal +5V and +V bus for the I/O modules is calculated in the PG5 Device Configurator.

<sup>3)</sup> Plug-in I/O terminal blocks are included with I/O modules. Spare terminals, ribbon connectors with system cables and separate terminals are ordered as accessories (see pages 34 and 78).

<sup>4)</sup> 4...20 mA via user program

<sup>5)</sup> At 100% output value and 3 kΩ load

<sup>6)</sup> With soldered I/O spring terminal block

## Information for project planning with PCD3 module holders

The internal load current taken by the I/O modules from the +5V and +V (24V) supply must not exceed the maximum supply current specified for the CPUs, RIOs or PCD3.C200 module holders.

### Example calculation for the current consumption of the internal +5V and +V (24V) bus of the I/O modules

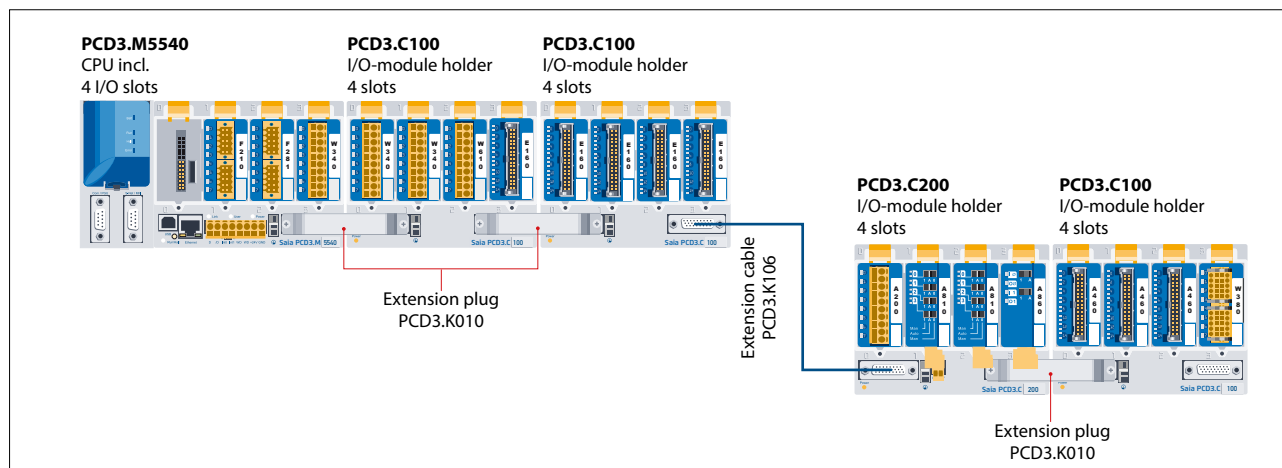

#### Consumption: M5540 + C100 + C100

Module	Internal 5V	Internal +V (24V)
Not used		
F210	110 mA	
F281	90 mA	15 mA
W340	8 mA	20 mA
<b>Total for M5540</b>	<b>208 mA</b>	<b>35 mA</b>
W340	8 mA	20 mA
W340	8 mA	20 mA
W610	110 mA	0 mA
E160	10 mA	
<b>Total for C100</b>	<b>136 mA</b>	<b>40 mA</b>
E160	10 mA	
E160	10 mA	
E160	10 mA	
E160	10 mA	
<b>Total for C100</b>	<b>40 mA</b>	<b>0</b>
<b>Total for M5540</b>	<b>384 mA</b>	<b>75 mA</b>

#### Consumption: C200 + C100

Module	Internal 5V	Internal +V (24V)
A200	15 mA	
A810	40 mA	
A810	40 mA	
A860	18 mA	
<b>Total for C200</b>	<b>113 mA</b>	
A460	10 mA	
A460	10 mA	
A460	10 mA	
W380	25 mA	25 mA
<b>Total for C100</b>	<b>55 mA</b>	<b>25 mA</b>
<b>Total for C200</b>	<b>168 mA</b>	<b>25 mA</b>

Capacity	PCD3.M5540	PCD3.C200
Internal 5V	600 mA	1500 mA
Internal +V (24V)	100 mA	200 mA

The calculation example given shows that internal capacity is maintained in the CPU basic module PCD3.M5540 and the holder module PCD3.C200. The CPU basic module has sufficient reserves to accommodate an additional communication module in the empty 0 slot. The holder module PCD3.C200 also has sufficient reserves for an additional PCD3.C100 or PCD3.C110 holder module to be connected. The power consumption of the internal +5V and +V (24V) bus for the I/O modules is calculated in the PG5 Device Configurator.



#### The following aspects should be considered when planning PCD3 applications:

- ▶ In keeping with lean automation, it is recommended to leave the first slot in the CPU basic module free for any subsequent expansions. Both simple I/O modules and communication modules can be used in this slot.
- ▶ The total length of the I/O bus is limited by technical factors; the shorter, the better.

The PCD3.C200 is used to extend the I/O bus or for the internal power supply (+5V and +V (24V)) to a module segment. Please note the following rules:

- ▶ Do not use more than six PCD3.C200s in one configuration, or the time delay will exceed the I/O access time.

- ▶ Use a maximum of five PCD3.K106/116 cables.
- ▶ After each cable (at the start of a row), insert a PCD3.C200. Exception: In a small configuration with no more than 3 PCD3.C1xxs, these can be supplied from the PCD3.Mxxx. A PCD3.C200 is not needed
- ▶ Where an application is mounted in a single row (max. 15 module holders), after every five PCD3.C100s a PCD3.C200 must be inserted to amplify the bus signal (unless the configuration ends with the fifth PCD3.C100).
- ▶ If the application is mounted in multiple rows, the restricted length of cable means that only three module holders (1× PCD3.C200 and 2× PCD3.C100) may be mounted in one row

## Saia PCD3 power supply and connection plan

### External power supply

For most modules, a full wave rectified power supply can be used.

The following modules must be connected to 24 VDC smoothed: PCD3.H1xx, H2xx, H3xx, PCD7.D2xx

Using robust and interference-resistant SBC power supply units with 24 VDC output is generally recommended. For available types see section 1.7 "accessories".

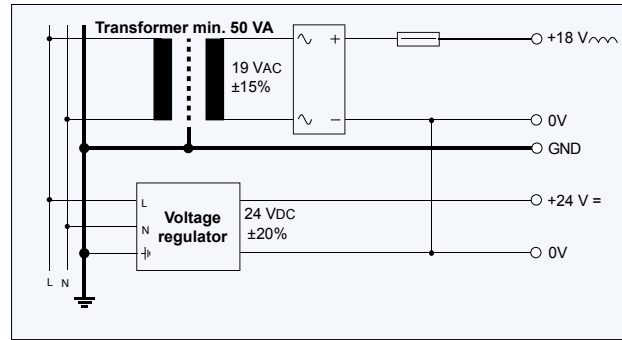

### Grounding and connection plan

- ▶ The zero-potential (GND) of the 24 V supply is connected to the GND and the controller's grounding terminal. This should be connected to the ground bar with the shortest possible wire (< 25 cm) of 1.5 mm<sup>2</sup>. The same applies to the negative connection to the PCD3.F1xx or the interrupt terminal.
- ▶ Any shielding of analog signals or communication cables should also be brought to the same grounding potential, either via a negative terminal or via the ground bar.
- ▶ All negative connections are linked internally. For problem-free operation, these connections should be reinforced externally by short wires with a cross-section of 1.5 mm<sup>2</sup>.

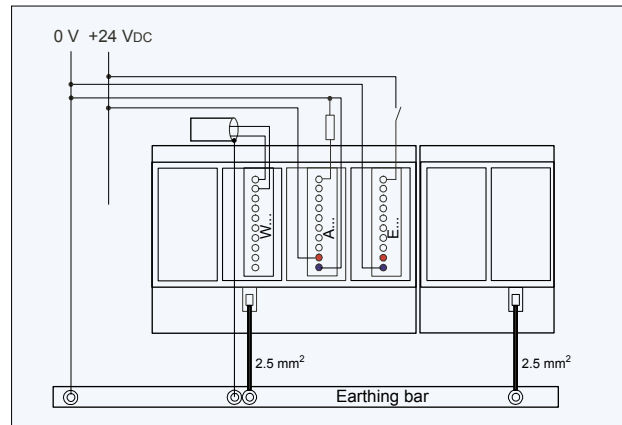

### Grounding and connection plan for analog inputs that are not isolated electrically (PCD3.W2x0, PCD3.W3x0)

Signal sources (such as temperature sensors) should be connected directly to the input module where possible.

The reference potentials of signal sources should be wired to a common GND connection ("-" and "COM" terminals). To obtain optimum measurement results, any connection to a ground bar should be avoided. Additional external GND connections to the sensor signals may result in equalizing currents which distort the measurement.

If shielded cables are used, the shield should be continued to a ground bar.

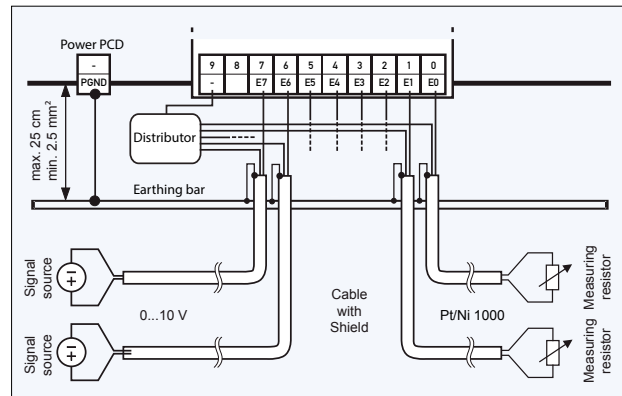
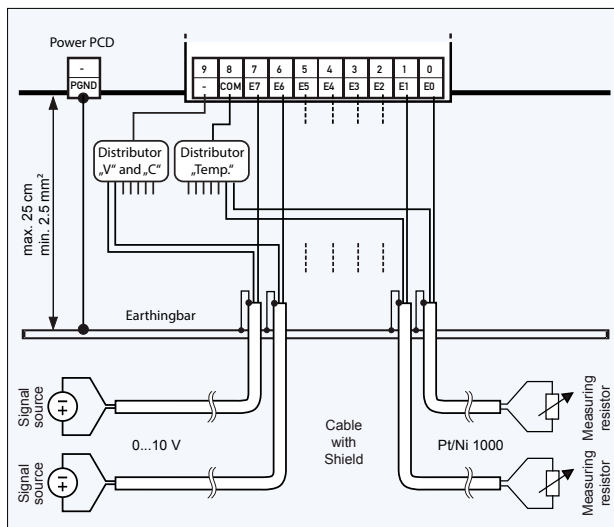

### Connection concept for PCD3.W2x0

The reference potential of signal sources must be wired to a common GND distribution at the "-" terminal

### Connection concept for PCD3.W3x0

The reference potential of voltage and current inputs must be wired to a common GND distribution at the "-" terminal. Temperature sensors must be wired to a common GND distribution at the "COM" terminal.

## Communication interfaces of Saia PCD3.Mxxxx controllers

In addition to the interfaces that the Saia PCD3 has onboard, the interface functions can also be expanded by means of various slots. Numerous protocols are therefore supported by the PCD3. For the majority of protocols, the physical bus specifications are offered as a plug-in module. If this is not the case, the bus can be connected via an external converter.

### Protocols supported by PCD3.Mxxxx via FBoxes

- ▶ Modem communication with the PCD
- ▶ S-Bus
- ▶ Modbus
- ▶ JCI N2-Bus
- ▶ KNX® S-Mode/EIB (with external converter)
- ▶ DALI
- ▶ EnOcean (with external converter)
- ▶ M-Bus
- ▶ BACnet® MS/TP
- ▶ HMI editor applications with PCD7.Dxxx text terminals (RS-232 only)

ref.Modbus

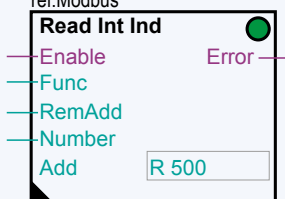

### PCD3.F1xx for slot 0

Port 1 RS-232  
or RS-422  
or RS-485  
or MP-Bus

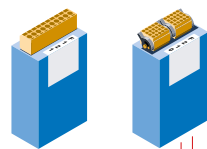

### PCD3.F2xx for slot no. 0...3

PCD3.F221 → RS-232  
PCD3.F210 → RS-422/RS-485  
PCD3.F281 → MP-Bus  
PCD3.F215 → BACnet®-MS/TP  
PCD3.F261 → DALI  
PCD3.F27x → M-Bus

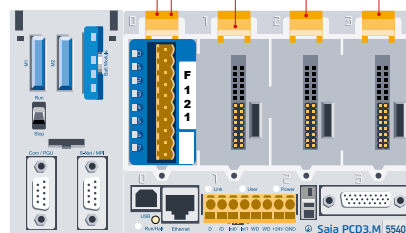

### Physical interfaces that can be freely programmed

Module	Specifications	Slot	Electrical isolation	Internal current draw 5V	+V (24V)	I/O connector type <sup>1)</sup>
PCD3.F110	RS-422 with RTS/CTS or RS-485, with activatable terminating resistors.	I/O 0	---	40 mA	---	A
PCD3.F121	RS-232 with RTS/CTS, DTR/DSR, DCD	I/O 0	---	15 mA	---	A
PCD3.F150	RS-485 with activatable terminating resistors.	I/O 0	•	130 mA	---	A
PCD3.F210	RS-422 / RS-485 plus PCD7.F1xxS as an option	I/O 0...3	---	110 mA	---	2x K
PCD3.F221	RS-232 plus PCD7.F1xxS as an option	I/O 0...3	---	90 mA	---	2x K

### Physical interfaces for specific protocols

Module	Specifications	Slot	Electrical isolation	Internal current draw 5V	+V (24V)	I/O connector type <sup>1)</sup>
PCD3.F180	Belimo MP-Bus, for connecting up to 8 drives on one line	I/O 0	---	15 mA	15 mA	A
PCD3.F215	BACnet® MS/TP	I/O 0...3	---	110 mA	---	2x K
PCD3.F240*	LONWORKS®-Interface-Modul only for PCD3.M5xx6x	I/O 0...3	---	90 mA	---	A9
PCD3.F261	DALI	I/O 0...3	---	90 mA	---	A
PCD3.F270	M-Bus 240 nodes	I/O 0...3	---	70 mA	8 mA	A
PCD3.F271	M-Bus 20 nodes	I/O 0...3	---	70 mA	8 mA	A
PCD3.F272	M-Bus 60 nodes	I/O 0...3	---	70 mA	8 mA	A
PCD3.F273	M-Bus 120 nodes	I/O 0...3	---	70 mA	8 mA	A
PCD3.F281	Belimo MP-Bus with slot for PCD7.F1xxS modules	I/O 0...3	---	90 mA	15 mA	2x K

<sup>1)</sup> Plug-in I/O terminal blocks are included with I/O modules.

Spare terminals, ribbon connectors with system cables and separate terminals are ordered as accessories (see pages 34 and 78).

### System properties of PCD3.F2xxx modules:

The PCD3 system has a processor, who handles both the application and the serial ports. To determine the maximum communication capacity for each PCD3.M5xxx system, consult the information and examples provided in Manual 26-789 for PCD3.M5xxx.

### Interface modules for optional insertion in PCD3.F2xx modules

Module	Specifications
PCD7.F110S	RS-422 with RTS/CTS or RS-485 (electrically connected), with activatable terminating resistors.
PCD7.F121S	RS-232 with RTS/CTS, DTR/DSR, DCD. Suitable for modem connection and EIB connection.
PCD7.F150S	RS-485 (electrically isolated), with activatable terminating resistors.
PCD7.F180S	Belimo® MP-Bus, for connecting up to 8 drives on one line

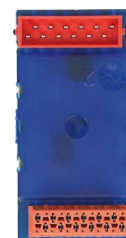

\*<sup>1)</sup> In preparation, see section C2 Product status



## Memory modules of Saia PCD3.Mxxxx controllers

In addition to the onboard memory contained within the base units, PCD3 controllers can also be expanded in a modular way with various flash memory modules for programs and data. The various communication protocols whose firmware is installed on the flashcards can also be used by simply inserting the relevant card.

More information to memory management and construction can be found in the section 1.1 Saia PCD® System description.

### System properties

- ▶ Configuration, programs and data can be transferred from one CPU to another
- ▶ Two slots (M1 and M2) for memory cards
- ▶ Additional memory cards can be inserted in the I/O slots using I/O adapters
- ▶ Memory can be expanded to 4 GByte

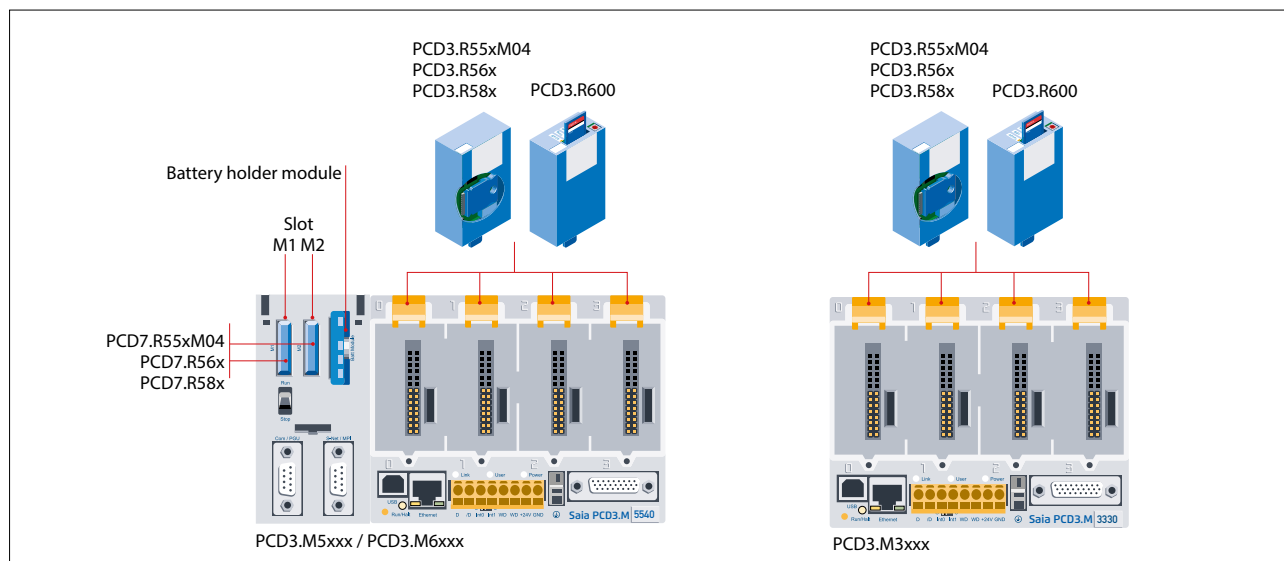

PCD7.R55xM04  
PCD7.R56x  
PCD7.R58x

PCD7.R610



### Flash memory with file system, program and data backup, BACnet® for slot M1/M2

Type	Description	Slot
PCD7.R550M04	4 MByte flashcard with file system	M1 & M2
PCD7.R560	Flashcard with BACnet®	M1 & M2
PCD7.R562	Flashcard with BACnet® and 128 MByte file system	M1 & M2
PCD7.R580	Flashcard with Lon IP	M1 & M2
PCD7.R582	Flashcard with Lon IP and 128 MByte file system	M1 & M2
PCD7.R610*	Base module for Micro SD Flash Card	M1 & M2
PCD7.R-MSD1024*	Micro SD Flash Card 1024 MB, PCD formatted	PCD7.R610



PCD3.R55xM04

PCD3.R56x

PCD3.R58x

### Plug-in flash modules for I/O-module slots of all PCD3.Mxxxx0s

Type	Description	Slot
PCD3.R550M04	4 MByte flashcard with file system	I/O 0...3
PCD3.R560	Flashcard with BACnet®	I/O 0...3
PCD3.R562	Flashcard with BACnet® and 128 MByte file system	I/O 0...3
PCD3.R580	Flashcard with Lon IP	I/O 0...3
PCD3.R582	Flashcard with Lon IP and 128 MByte file system	I/O 0...3



PCD3.R600

### Saia PCD3 basic module for SD flashcards with file system

Type	Description	Slot
PCD3.R600	Basic module with slot for SD flashcards (Up to 4 modules in I/O slots 0 to 3 on a CPU)	I/O 0...3
PCD7.R-SD512	SD flashcard, 512 MByte with file system	---
PCD7.R-SD1024	SD flashcard, 1024 MByte with file system	---

Spare parts (battery and battery holder module) see Consumables and accessories

\*) In preparation, see section C2 Product status



## Consumables and accessories for Saia PCD3 controllers

### Labeling accessories

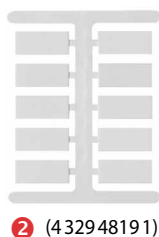
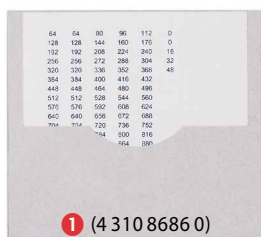

Type  
(4 310 8723 0)

### Addressing and marking I/O modules and module holders

I/O-module slots in the module holder are labeled with numbers:

- ▶ 0...3 (PCD3.Mxxxx /T66x/C100, C200)
- ▶ 0...1 (PCD3.C110)

The provided inscription labels **2** can either be used for additional labeling of the module holders, or for the I/O modules themselves. They are blank and, depending on requirements, may either be labeled by hand or by means of preprinted adhesive strips **1**.

The circuit diagram **3** printed on the side of each I/O-module not only makes wiring easier, it also helps during commissioning. Sufficient space **4** is available on the opposite side of the cassette for the user to add customized labeling.

### Additional labeling on the front **5**

The PCD3 modules can also be labeled on the front panel. Optionally, neutral labels with a snap-on cover (clip) are available for this purpose.

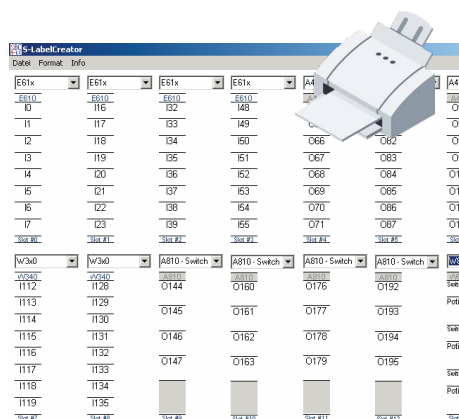

## Consumables and accessories for Saia PCD3.Mxxxx controllers



### Saia PCD3 battery and battery holder module

Type	Description
PCD3.R010	Battery kit for PCD3.M3xxx Basic CPU (battery module for slot#3 incl. lithium battery CR2032)
4 639 4898 0	Battery holder module (for PCD3.M5xxx)
4 507 4817 0	Lithium battery for PCD Basis CPU

### Saia PCD3 housing covers

Type	Description
4 104 7493 0	Cover for PCD3.M5xxx and M6xxx
PCD3.E009	Empty module housing for unused PCD3 I/O slots
4 104 7515 0	Slot cover for unused PCD3 I/O slots
4 104 7502 0	Slot cover for unused PCD3 I/O slots without SBC logo



### Saia PCD3 plug-in terminal blocks for basic modules and module holders

Type	Description
4 405 4995 0	8-pin spring terminal block for power supply to PCD3.Mxxxx
4 405 4952 0	2-pin screw terminal block for power supply to PCD3.C200

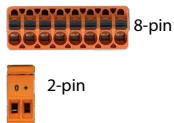

### Saia PCD3 plug-in terminal blocks and labeling for I/O modules

Type	Description
4405 4954 0	Plug-in I/O spring terminal block 10-pin for wires up to 2.5 mm <sup>2</sup> type A
4405 4956 0	Plug-in I/O spring terminal block 24-pin for wires up to 1,0 mm <sup>2</sup> type C
4405 4998 0	Plug-in I/O spring terminal block 14-pin for wires up to 1,5 mm <sup>2</sup> type E
4405 4936 0	Plug-in I/O spring terminal block 12-pin for PCD3.A810 for wires up to 1,5 mm <sup>2</sup> type F
4405 5027 0	Plug-in I/O spring terminal block 4-pin for PCD3.A860 for wires up to 2,5 mm <sup>2</sup> type G
4405 5028 0	Plug-in I/O spring terminal block 6-pin for PCD3.A860 for wires up to 1,0 mm <sup>2</sup> type H
4405 5113 0	Plug-in I/O spring terminal block 9-pin for PCD3.F240 for wires up to 2,5 mm <sup>2</sup> type A9
4405 4934 0	Plug-in I/O spring terminal block 8-pin for PCD3.W800 for wires up to 1,5 mm <sup>2</sup> type J
4405 5048 0	Plug-in I/O spring terminal block 10-pin for wires up to 1,0 mm <sup>2</sup> type K
4 310 8723 0	Set of 10: Transparent snap-on label holder including neutral inscription labels (2x DIN A4)
4 329 4819 1	Set of 10: Snap-on inscription carrier for modules
4 310 8686 0	Set of 10: Preprinted adhesive strips for snap-on label holder

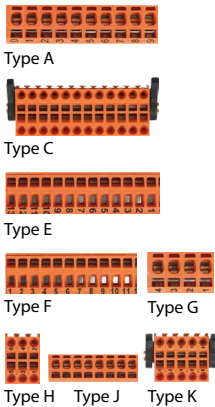

### System cables & "ribbon-screw terminal" adapters (see section 1.7 for details)

Type	Description
<b>System cables for digital modules with 16 I/Os</b>	
PCD2.K221	Sheathed, round cable with 32 strands of 0.25 mm <sup>2</sup> , 1.5 m long PCD side: 34-pin ribbon cable connector type D, process side: strand ends free, color coded
PCD2.K223	Sheathed, round cable with 32 strands of 0.25 mm <sup>2</sup> , 3.0 m long PCD side: 34-pin ribbon cable connector type D, process side: strand ends free, color coded
<b>System cables for adapters PCD2.K520/..K521/..K525</b>	
PCD2.K231	Sheathed, half-round cable with 34 strands, each 0.09 mm <sup>2</sup> , 1.0 m long, 34-pin ribbon connector at both ends type D
PCD2.K232	Sheathed, half-round cable with 34 strands, each 0.09 mm <sup>2</sup> , 2.0 m long, 34-pin ribbon connector at both ends type D
<b>System cables for 2 adapters PCD2.K510/..K511 or 1 adapter and relay interface PCD2.K551</b>	
PCD2.K241	Sheathed, half-round cable with 34 strands, each 0.09 mm <sup>2</sup> , 1.0 m long, PCD side: 34-pin ribbon connector type D, process side: two 16-pin ribbon connector
PCD2.K242	Sheathed, half-round cable with 34 strands, each 0.09 mm <sup>2</sup> , 2.0 m long, PCD side: 34-pin ribbon connector type D, process side: two 16-pin ribbon connector

### "Ribbon/screw terminal" adapters

Type	Description
PCD2.K510	for 8 inputs/outputs, with 20 screw terminals without LED
PCD2.K511	for 8 inputs/outputs, with 20 screw terminals and LED (for source operation only)
PCD2.K520	for 16 inputs/outputs, with 20 screw terminals without LED
PCD2.K521	for 16 inputs/outputs, with 20 screw terminals and LED (for source operation only)
PCD2.K525	for 16 inputs/outputs, with 3 × 16 screw terminals and LED (for source operation only)
PCD2.K551	Relay interface for 8 PCD transistor outputs with 24 screw terminals and LED
PCD2.K552	Relay interface for 8 PCD transistor outputs with 24 screw terminals, LED and manual control mode (on-off-auto switch) and 1 output as feedback for manual control

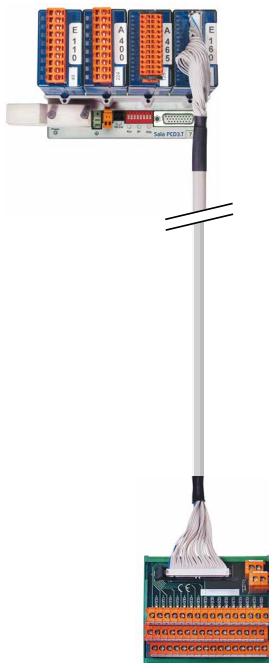

## 1.2.2 Saia PCD3.M2130V6 Compact

The PCD3 Compact brings together a high degree of functionality in a very compact space. With its compact dimensions, it can fit into the smallest switch cabinets. This makes it ideal for upgrading existing installations. It includes all the features of PCD3 technology and also has I/Os directly onboard.



### System properties

- ▶ Freely programmable with PG5
- ▶ Compact dimensions: 130 × 140 × 74 mm (W × H × D)
- ▶ Integral interfaces: USB, Ethernet and RS-485
- ▶ Slot A for optional PCD7.F1xxS serial communication modules
- ▶ 38 inputs/outputs already in base unit
- ▶ Replaceable lithium battery
- ▶ Configurable analog inputs for voltage, current and temperature
- ▶ Expandable with PCD3.C200 or PCD3.C110 I/O-module holder
- ▶ Local I/O expansion with remote I/O PCD3.T66x (Ethernet) or PCD3.T760 (Profi-S-IO)

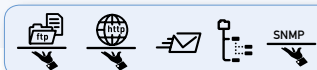

Automation Server  
integrated in  
the base unit

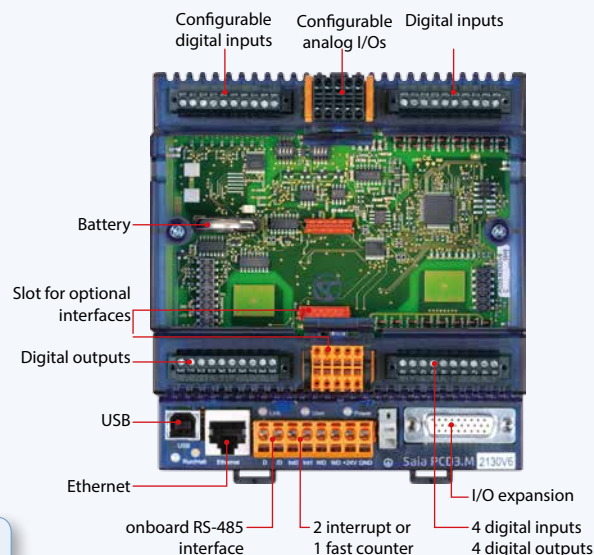

### On-Board inputs/outputs

Type	Number	Input voltage	Signal ranges	Breaking capacity VDC	Resolution	I/O connector type
Digital inputs	20	15...30 VDC	---	---	---	Plug-in screw terminals or push-in terminals with LED (optional)
Digital outputs Transistor	12	---	---	0,5 A / 5...32 VDC	---	Plug-in screw terminals or push-in terminals with LED (optional)
Analog inputs Configurable	4	---	-10 V ... +10 V / 0 ... 20 mA Pt/Ni 1000, Ni 1000 L&S, resistance 0...2500 Ω	---	13-bit / 12-bit	Plug-in spring terminals
Analog outputs	2	---	0 ... 10 V	---	12-bit	Plug-in spring terminals

### Dimensions

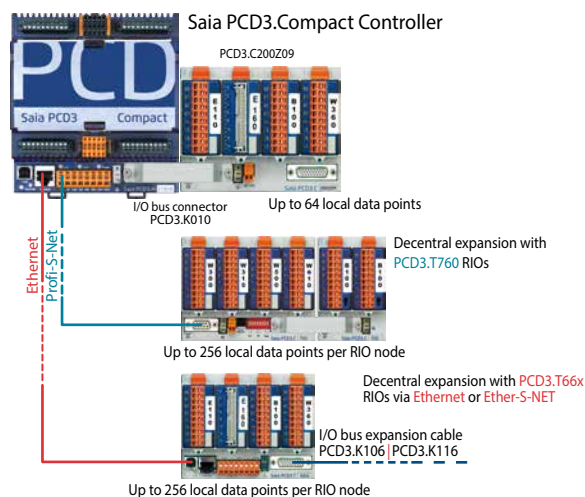
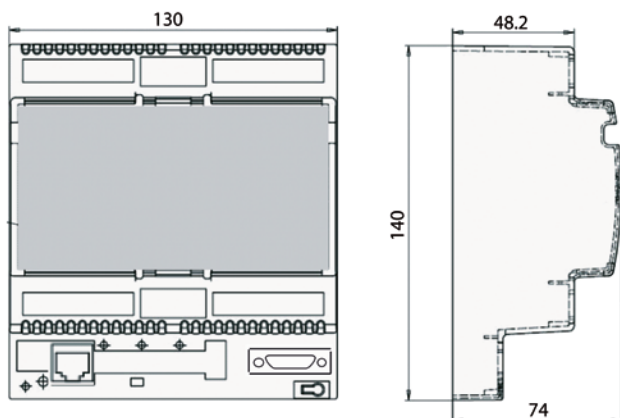

1 Automation stations

2 HMI Visualization and operating

3 Dedicated room controller

4 Consumption data acquisition

5 Cabinet components

## Performance overview and accessories

### Power supply

Type	Description
Supply voltage (according to EN/IEC 61131-2)	24 VDC -20/+25% incl. 5% ripple
Current draw / Input power	typically 175 mA / 4.2 W max. 500 mA / 12 W
Load capacity 5 V / +V internal	max. 600 mA / 100 mA
Reclosing (according to EN/IEC 61131-2)	≤ 10 ms at interval ≥ 1 s
Watchdog relay, make contact	48 VAC or VDC, 1 A

### Communication interfaces to field level, options in slot A

PCD7.F110S	RS-422 with RTS/CTS or RS-485 electrically connected, with line termination resistors capable of activation. Suitable for Modbus, S-Bus, EnOcean, etc.
PCD7.F121S	RS-232 with RTS/CTS, DTR/DSR, DCD. Suitable for modem, EIB, DALI connection.
PCD7.F150S	RS-485 (electrically isolated), with line termination resistors capable of activation,
PCD7.F180S	Belimo® MP-Bus, for connecting up to 8 drives on one line

### I/O expansions

Type	Description	Capacity
PCD3.C110Z09	2 module slots (connection with PCD3.K010 connector or cable PCD3.K106/K116)	0 mA
PCD3.C200Z09	4 module slots, with 24 VDC supply (connection with PCD3.K010 cable or cable PCD3.K106/K116)	1500 mA / 200 mA (5 V / +V)
PCD3.C110	2 module slots (connection with PCD3.K106/K116 cable only)	0 mA
PCD3.C200	4 module slots, with 24 VDC supply (connection with PCD3.K106/K116 cable only)	1500 mA / 200 mA (5 V / +V)

I/O-modules see pages 27 and 28

### Ordering information

Type	Description
PCD3.M2130V6	Base units with 38 I/Os (with plug-in terminal blocks) CPU with 512 kByte user program, backup with onboard flash memory, 1 MByte File System, USB port for programming with PG5, RS-485 interface, 2 interrupt inputs, integral Web & FTP server, 1 port (slot A) for PCD7.F1xxS communication modules, lithium battery for data backup for 1...3 years, Ethernet TCP/IP interface
PCD3.M2030V6	Same as PCD3.M2130V6 but without Ethernet TCP/IP interface
4 405 5066 0	Optional: pluggable 10-pin push-in terminal block with LEDs, for digital I/Os
4 405 5079 0	Optional: 3×10 pin (3-wire connection), pluggable push-in terminal block with LEDs, for digital I/Os



## 1.2.3 Saia PCD3.M2330A4Tx Wide Area Controller

Saia PCD3 Wide Area Controllers are freely programmable, industrial devices for control and automation devices with web, IT and telecommunications functions. Its potential uses therefore extend much further than those of a classic RTU station, which is normally only suitable for alarm monitoring with remote alarms and data logging. The PCD3 Wide Area Controller is also suitable for sophisticated control tasks.



### System properties

- ▶ Freely programmable with PG5
- ▶ Compact dimensions: 130 × 140 × 74 mm (W × H × D) (without antenna)
- ▶ Management of historical data with up to 1 GByte flash memory
- ▶ Integral telecommunications interface (ISDN, PSTN, GSM/GPRS)
- ▶ Always accessible, thanks to redundant communication
- ▶ 14 inputs/outputs already in base unit

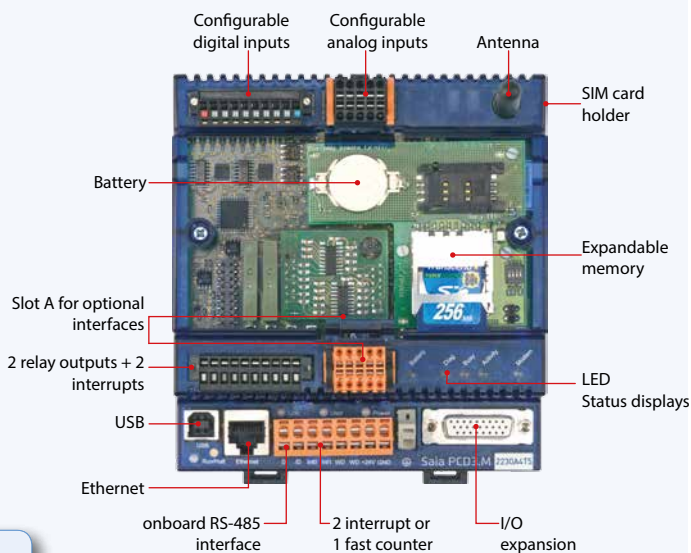

### On-Board inputs/outputs

I/O data point	Properties
8 digital inputs + 2 interrupts	15...30 VDC
2 relay outputs	DC 2 A/50 V, AC 6 A/250 V
4 configurable analog inputs	-10...+10 VDC, 0...±20 mA, Pt1000, Ni1000, Ni1000 L&S, 0...2.5 kΩ

### On-Board interfaces

Interface	Transmission rate
RS-485 (serial) on terminal block for free protocols or Profi-S-Net / Profibus-DP Slave	≤ 115.2 kbit/s ≤ 187.5 kbit/s
Ethernet TCP/IP	10/100 Mbit/s
USB 1.1 slave (PGU)	

### Dimensions

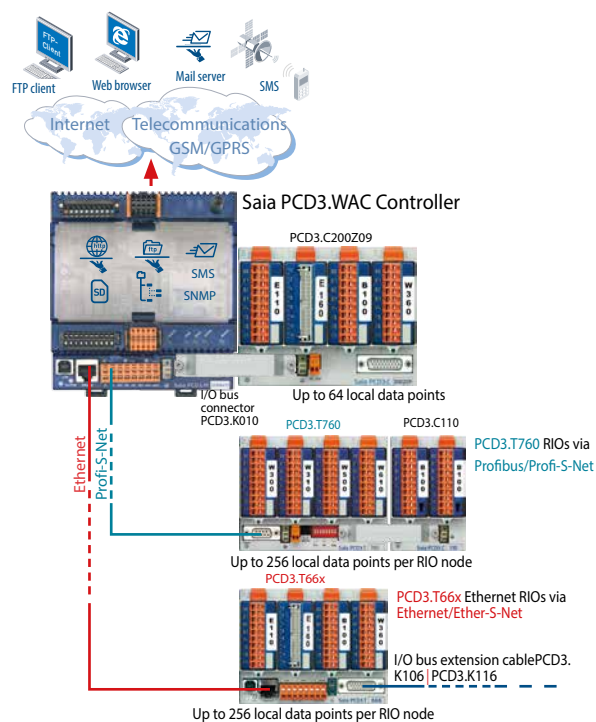
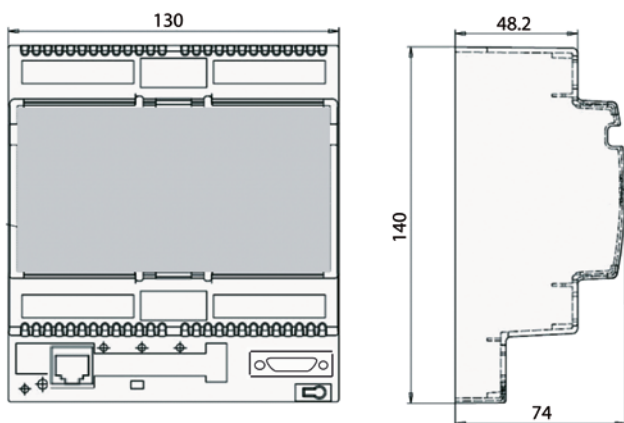

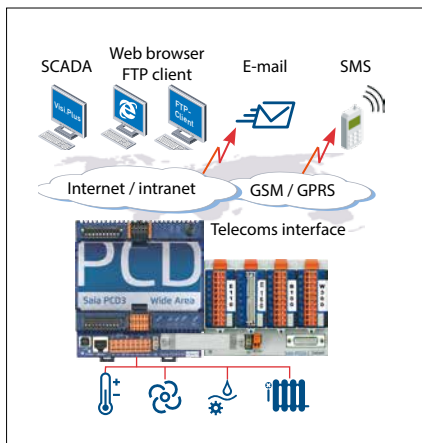

#### PCD3.WAC as RTU controller

Send SMS messages and emails through the GSM/GPRS network. Use the PCD3.WAC with local I/Os and send messages, statuses or alarms to the SCADA system or, by email and SMS, to the end user.

Via integrated web and FTP servers, external stations are easily brought together across internet and internet. The integrated web server also permits access to external stations via standard web browsers.

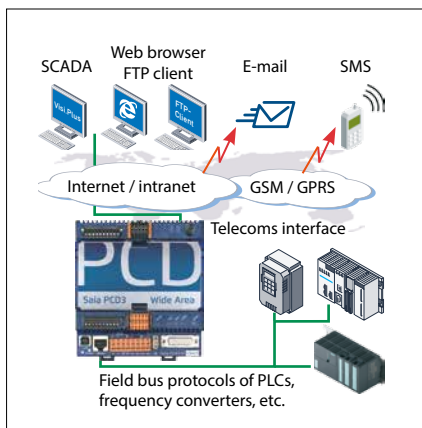

#### WAC communications gateway

With integrated protocols such as FTP, HTTP, or by using open data modes, Ethernet, or a serial interface, the Saia PCD3.WAC can be used for non-SBC systems as a communications gateway to Internet or intranet applications.

Many field bus protocols are supported at the field level, such as Modbus TCP/RTU/ASCII, EIB, M-Bus, etc.

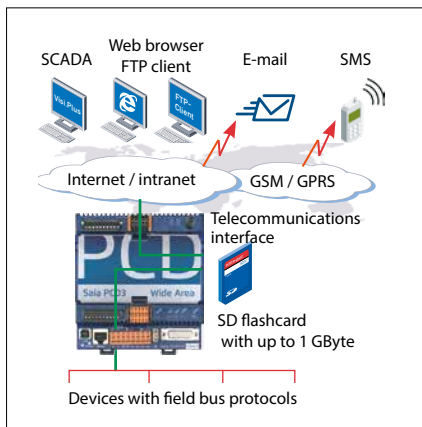

#### Ready for data management:

With up to 1 GByte of memory, the Saia PCD3.WAC has enough memory to store data received from the field level over a long period. This data can be processed directly by the Saia PCD<sup>®</sup> and then transferred to the management or upstream monitoring systems by e-mail, FTP, HTTP or data communication. This makes the Saia PCD3 Wide Area Controller independent of management stations and therefore suitable as a data concentrator.

Many potential uses can be found with remote operation and control wherever measurements have to be taken, the statuses of systems monitored, and the relevant data transferred.

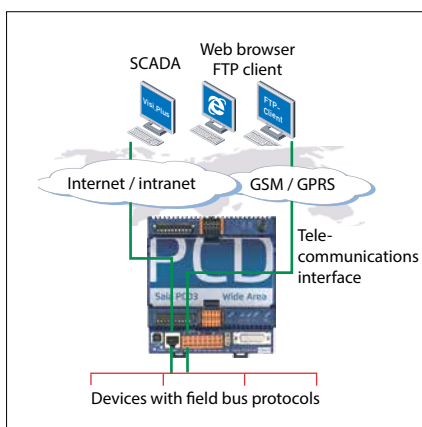

#### Always available, thanks to redundant communication

Bridging geographical distances is often a requirement for systems with a large number of distributed stations. With integrated telecommunications interfaces (GSM/GPRS, PSTN or ISDN) and an Ethernet interface, the Wide Area Controller is permanently available via its telecommunications interface and Ethernet port. Redundant communication paths (telecommunications or Ethernet interface) increase the reliability and availability of the system.



## Performance overview, ordering information and accessories

### CPU technology

RAM as program memory	512 kByte
Back-up memory (flash)	512 kByte
Memory for file system (flash)	1 MByte (onboard)
PCD media	8,192 flags, 16,384 × 32-bit register

### Telecom communication interface (alternatively integrated interfaces)

GSM / GPRS / PSTN / ISDN / SMS – sending and receiving

### Internet and intranet protocols

HTTP server	Visualization with web browser and web panel
FTP server	Easy exchange of data
TCP/IP-PPP Point-to-Point Protocol	Efficient communication
SMTP client	Sending e-mails with files (e.g. log files) as attachments
DHCP and DNS client	Easy integration into IP networks
SNTP client	Synchronization of the internal clock
SNMP agent	Network management

### Field level protocols

Serial-S-Bus, Ether-S-Bus and Profi-S-Bus

MODBUS RTU or TCP EIB M-Bus IEC 870-5-101/103/104

For other protocols please refer to section B2

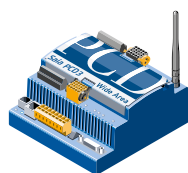

### Types

PCD3.M2330A4T1	with PSTN modem
PCD3.M2330A4T3	with ISDN modem
PCD3.M2330A4T5	with GSM/GPRS modem (without antenna)
PCD3.M2230A4T5	with GSM/GPRS modem, without Ethernet (without antenna)



### Additional data storage

Slot for SD flashcards	SBC SD card with up to 1 GByte file system
Data files with up to 900 files with Saia file system	Download and upload via ftp
PCD7.R-SD512	SBC SD flashcard, 512 MByte with file system
PCD7.R-SD1024	SBC SD flashcard, 1024 MByte with file system



### Communication modules for slot A

PCD7.F110S	RS-422 with RTS/CTS or RS-485 electrically connected, with line termination resistors capable of activation. Suitable for Modbus, S-Bus, EnOcean, etc.
PCD7.F121S	RS-232 with RTS/CTS, DTR/DSR, DCD. Suitable for modem, EIB, DALI connection.
PCD7.F150S	RS-485 (electrically isolated), with line termination resistors capable of activation,
PCD7.F180S	Belimo® MP-Bus, for connecting up to 8 drives on one line

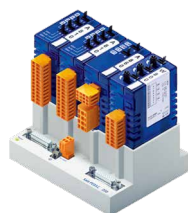

### I/O expansions

PCD3.C110Z09	2 module slots (connection with PCD3.K010 connector or with PCD3.K106/K116 cable)	0 mA
PCD3.C200Z09	4 module slots, with 24 VDC supply (connection with PCD3.K010 connector or with PCD3.K106/K116 cable)	1500 mA / 200 mA (5 V / +V)
PCD3.C110	2 module slots (connection with PCD3.K106/K116 cable only)	0 mA
PCD3.C200	4 module slots, with 24 VDC supply (connection with PCD3.K106/K116 cable only)	1500 mA / 200 mA (5 V / +V)

I/O-modules see pages 27 and 28



## 1.3 Saia PCD2 programmable controllers

### Overview of Saia PCD2 device series

#### Saia PCD2.M5 controllers

Page 42



##### Base units with 8 slots for I/O modules

- ▶ PCD2.M5440 Basic
- ▶ PCD2.M5540 Extended with Ethernet switch

Up to 4 integrated communication interfaces, can be expanded to max. 15 communication interfaces with plug-in modules. Integrated Automation Server in all CPUs.

#### Saia PCD2 module holder for I/O expansion

Page 43

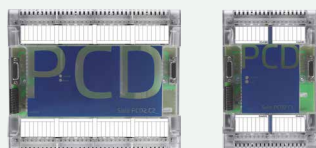

##### Module holder for I/O modules

- ▶ PCD2.C1000 4 I/O slots
- ▶ PCD2.C2000 8 I/O slots

Expansion to max. 1,023 I/Os

#### Saia PCD2 input/output modules

Page 45



##### Modules with various functions with plug-in terminals

- ▶ PCD2.Exxx Digital input modules
- ▶ PCD2.Axxx Digital output modules
- ▶ PCD2.Bxxx Combined digital input/output modules
- ▶ PCD2.Wxxx Analog input/output modules

#### Saia PCD2 interface modules

Page 48



##### Plug-in modules to expand the communication interfaces (up to 4 modules or 8 interfaces)

- ▶ PCD2.F1xxS 1 serial interface RS-232, RS-422/485, Belimo MP-Bus
- ▶ PCD2.F2xxx 2 serial interfaces RS-232, RS-422/RS-485
- ▶ PCD2.F2150 BACnet® MSTP
- ▶ PCD2.F2610 DALI
- ▶ PCD2.F27x0 M-Bus
- ▶ PCD2.F2180 Belimo MP-Bus

#### Saia PCD2 memory modules

Page 49



##### Plug-in memory modules for data and program backup

- ▶ PCD2.R6xx Basic module for SD flash memory card for slots 0...3
- ▶ PCD2.R-SD SD flash memory cards for PCD3.R6xx
- ▶ PCD2.R5xx Flash memory module for slots M1 & M2

#### Consumables and accessories for Saia PCD2 controllers

Page 52



Housing covers, plug-in screw terminal blocks, I/O bus connection, battery, system cables and adapters

## Saia PCD2.M5xxx controllers

Due to its flat housing design, the Saia PCD2.M5xxx is especially suitable for space-saving applications. The powerful CPU enables the control and regulation functions of complex applications with up to 1,023 central data points. The PCD2 can be expanded by means of plug-in memory modules to become a LoN IP® or BACnet®-enabled controller. The PCD2 has communication interfaces such as USB, Ethernet, RS-485 and Automation Server On-Board.

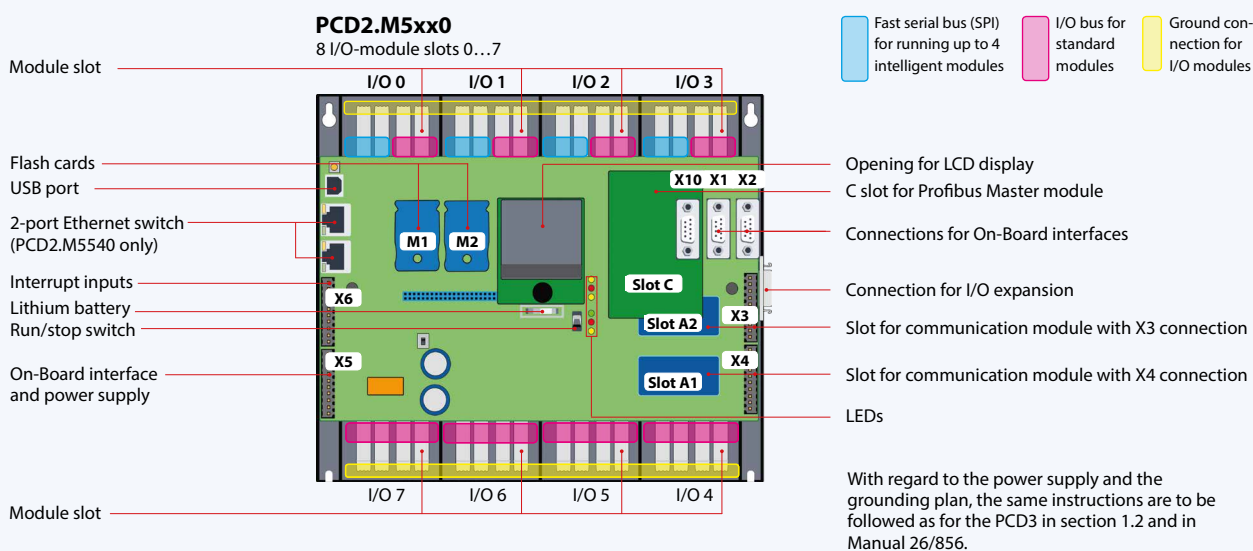
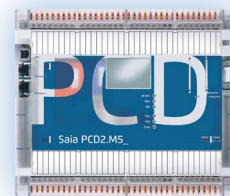

### System properties

- ▶ Up to 15 communication interfaces (RS-232, RS-485, etc.)
- ▶ 8 I/O slots that can be expanded by means of module holders to max. 64 slots (1,023 central data points)
- ▶ Local I/O expansion with RIO-PCD3.T66x (Ethernet) or PCD3.T760 (Profi-S-IO)
- ▶ 1 MByte of program memory
- ▶ Automation Server On-Board
- ▶ Data memory with flash memory modules that can be expanded to 4 GByte
- ▶ 6 fast interrupt/counter inputs on the CPU
- ▶ Compatible with all PCD3 module holders

### On-Board interfaces of the Saia PCD2.M5xxx

Type	Connection	Port	Transmission rate
RS-232 (serial) or RS-485 (serial)	X2 (D-Sub) X5 (terminal)	0 0	≤ 115.2 kbit/s ≤ 115.2 kbit/s
RS-485 (serial) for free protocols or Profi-S-Net / Profibus-DP Slave	X1 (D-Sub) X1 (D-Sub)	3 10	≤ 115.2 kbit/s ≤ 1.5 Mbit/s
Ethernet (2 port switch) (PCD2.M5540 only)	Ethernet	9	10/100 Mbit/s
USB 1.1 (PGU)	USB	---	≤ 12 Mbit/s

### Dimensions

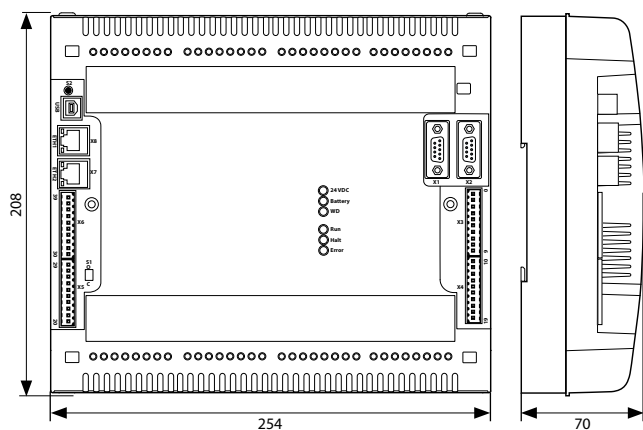

### Mounting

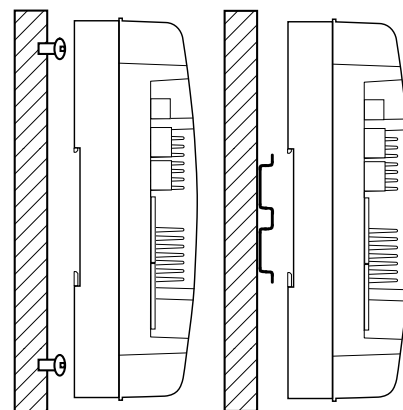

## Saia PCD2.Cxxxx module holder

Up to 7 Saia PCD2.C1000 or Saia PCD2.C2000 module holders can be connected to the Saia PCD2.M5xxx. This makes it possible to connect up to 64 I/O modules or 1023 digital inputs/outputs. A module holder has space for 4/8 I/O modules. In addition to Saia PCD2.Cxxxx module holders, all Saia PCD3 module holders can also be connected.

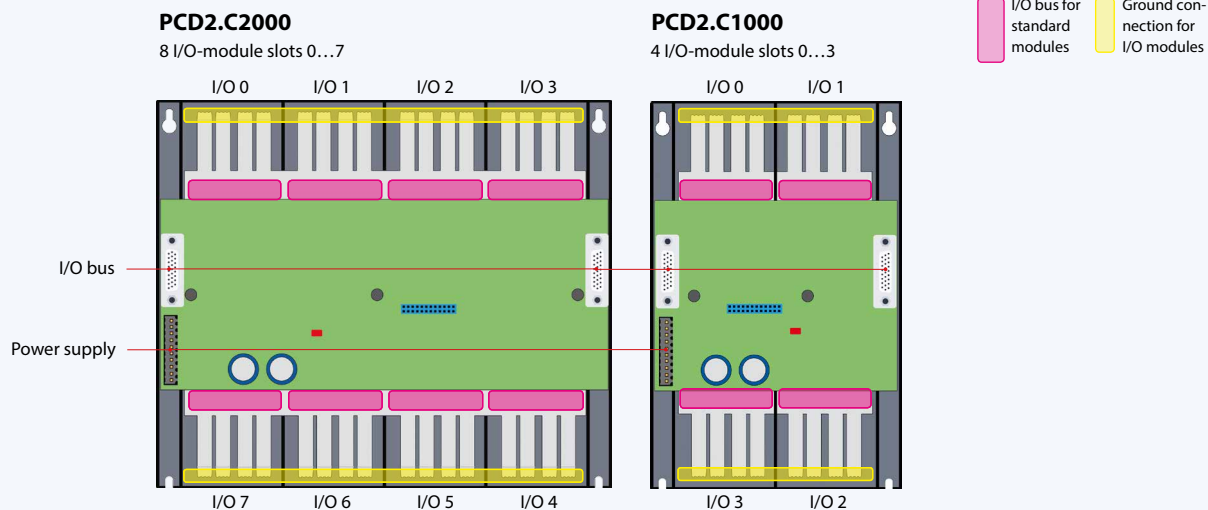

### System properties

- ▶ Up to 1,023 central data points
- ▶ Numerous module variants can be plugged in
- ▶ Mounting is quick and easy
- ▶ Can be combined with Saia PCD3.Cxxx module holders
- ▶ Connections for a power supply on each module holder
- ▶ Can be connected below or next to each other

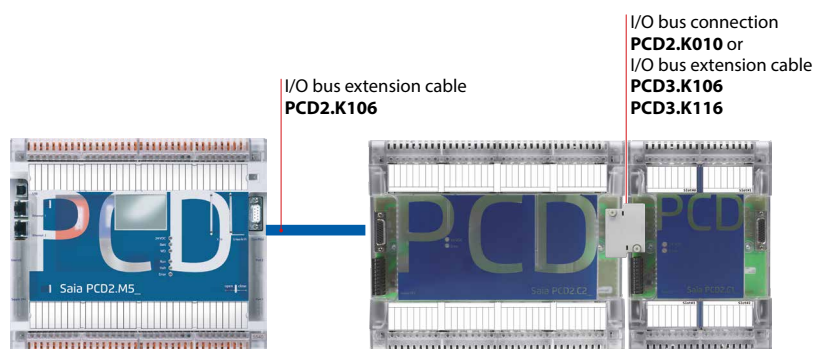

A maximum of 7 module holders can be connected to a PCD2.M5xxx. In this case, no more than 5 extension cables may be used. PCD3.Kxxx cables required for connection between two module carriers.

### Dimensions of PCD2.C2000

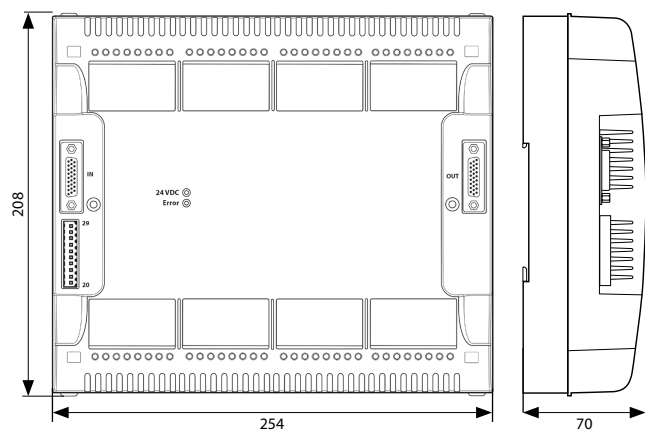

### Dimensions of PCD2.C1000

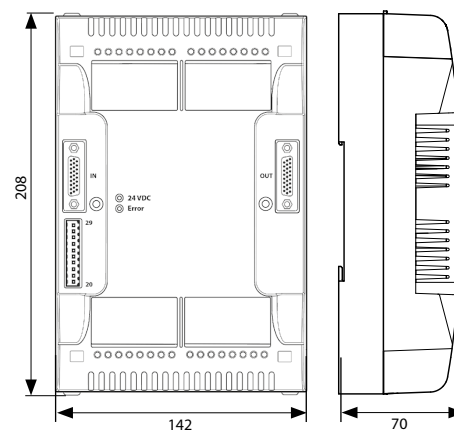

## Technical data and ordering information for PCD2.M5xxx controllers



### Technical overview

#### Technical data

Number of digital inputs/outputs On-Board	6 digital inputs (24 V, 4× interrupts) 2 digital outputs (2× PWM, 24 V 100 mA)
Number of digitale inputs/outputs ind the base unit	128
resp. /O module slots in the base unit	8
Number of digital inputs/outputs with 7 PCD2.C2000 module holder	896
resp. I/O-module slots	56
Processing time [µs]	bit operation 0,3...1,5 µs word operation 0,9 µs
Real time clock (RTC)	yes

#### Memory On-Board

Main memory (RAM) for program and DB/TEXT	1 MByte
Flash memory (S-RIO, configuration and backup)	2 MByte
User flash file system (INTFLASH)	No
Data backup	1...3 years with lithium battery

#### Communication interfaces On-Board

RS-232, RS-485 / PGU	≤ 115 kbit/s
RS-485 Profibus-DP-Slave, Profi-S-Net (S-IO, S-Bus)	≤ 1,5 Mbit/s
USB 1.1 (PGU)	≤ 12 Mbit/s
Ethernet, 2 port switch (PCD2.M5540 only)	≤ 10/100 Mbit/s (full duplex, auto-sensing/auto-crossing)

#### Genera data

Supply voltage (according to EN/IEC 61131-2)	24 VDC -20/+25 % max. incl. 5% ripple
Loading capacity 5 V / + V internal	max. 1400 mA / 800 mA
Automation Server	Flash memory, file system, FTP and web server, e-mail, SNMP

### Ordering information

#### Saia PCD2

Type	Description
<b>PCD2.M5440</b>	Programmable controller, 1024 kByte of RAM
<b>PCD2.M5540</b>	Programmable controller, 1024 kByte of RAM, Ethernet interface

#### Saia PCD2 I/O-module holder

Type	Description
<b>PCD2.C1000</b>	Extension module holder with 4 I/O slots
<b>PCD2.C2000</b>	Extension module holder with 8 I/O slots
<b>PCD2.K010</b>	I/O bus connector
<b>PCD2.K106</b>	I/O bus extension cable Length 0.9 m (Connection between PCD2.M5xxx and PCD2.Cxxxx)
<b>PCD3.K106</b>	I/O bus extension cable Length 0.7 m (Connection between two module holder)
<b>PCD3.K116</b>	I/O bus extension cable Length 1.2 m (Connection between two module holder)

Additional accessories such as connectors, covers, etc. are described on the last page of this section.



## Saia PCD2 Plug-in I/O modules: Overview

The functions of Saia PCD2 can be expanded as required using a wide range of plug-in I/O modules and can be adapted to the specified needs. This not only ensures that a project can be implemented quickly but also provides the option of expanding the system at any time during operation.

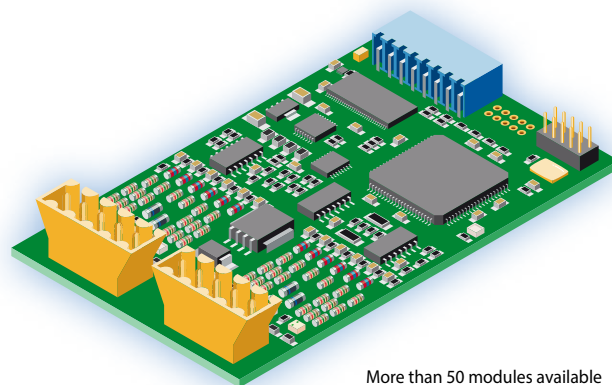

More than 50 modules available with differing functionalities

### System properties

- ▶ Numerous variants available
- ▶ Slot directly in the Saia PCD2.M5xxxx, PCD1.M2xxx or in the module holder
- ▶ Full integration into the Saia PCD2 housing
- ▶ Compact design
- ▶ Up to 16 I/Os per module
- ▶ Modules with an input delay of 0.2 ms

### General type key

- ▶ PCD2.Axxx Digital output modules
- ▶ PCD2.Bxxx Digital combined input/output modules
- ▶ PCD2.Exxx Digital input modules
- ▶ PCD2.Fxxx Communication modules
- ▶ PCD2.Hxxx Fast counter modules
- ▶ PCD2.Rxxx Memory modules
- ▶ PCD2.Wxxx Analog input/output modules



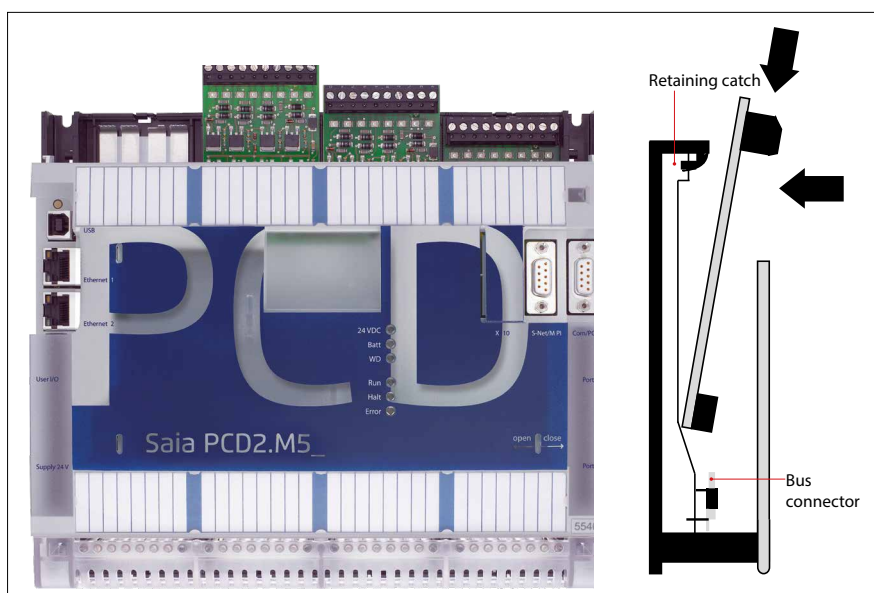

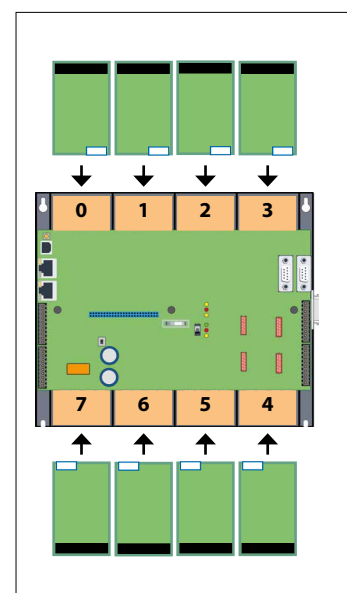

### Insertion in housing



### Slots for I/O modules



### Differences between the terminals of the I/O modules

Type K	Type L	Type M	Type N	Type O	Type P	Type R
2 × 5-pin connector	10-pin connection terminal plug-in	14-pin connection terminal plug-in	20-pin connection terminal	34-pin ribbon connector	14-pin connection terminal	17-pin connection terminal
						

The screw terminal blocks and connectors can also be ordered individually as accessories.

## Saia PCD2 Digital input and output modules

The digital I/O modules can be easily plugged into Saia PCD2 and Saia PCD1 base units or an appropriate I/O-module holder. In addition to inputs for various voltage levels, digital outputs are provided with both transistor construction and as mechanical relays. This means that electrical isolation from the switching electrical circuit can be achieved easily and reliably.

### Digital input modules

Type	Number of inputs	Input voltage	Breaking capacity		Input filter	Electrical isolation	Current draw		I/O connector type <sup>3)</sup>
			DC	AC			5 V bus <sup>1)</sup>	+ V bus <sup>2)</sup>	
PCD2.E110	8 I	15...30 VDC	---	---	8 ms	---	24 mA	---	L
PCD2.E111	8 I	15...30 VDC	---	---	0.2 ms	---	24 mA	---	L
PCD2.E112	8 I	7.5...15 VDC	---	---	9 ms	---	24 mA	---	L
PCD2.E116	8 I	3.5...7 VDC	---	---	0.2 ms	---	24 mA	---	L
PCD2.E160	16 I	15...30 VDC	---	---	8 ms	---	72 mA	---	O
PCD2.E161	16 I	15...30 VDC	---	---	0.2 ms	---	72 mA	---	O
PCD2.E165	16 I	15...30 VDC	---	---	8 ms	---	72 mA	---	N
PCD2.E166	16 I	15...30 VDC	---	---	0.2 ms	---	72 mA	---	N
PCD2.E500	6 I	80...250 VAC	---	---	20 ms	●	1 mA	---	L
PCD2.E610	8 I	15...30 VDC	---	---	10 ms	●	24 mA	---	L
PCD2.E611	8 I	15...30 VDC	---	---	0.2 ms	●	24 mA	---	L
PCD2.E613	8 I	30...60 VDC	---	---	9 ms	●	24 mA	---	L
PCD2.E616	8 I	3.5...7 VDC	---	---	0.2 ms	●	24 mA	---	L

### Digital output modules

Type	Number of outputs	Input voltage	Breaking capacity		Input filter	Electrical isolation	Current draw		I/O connector type <sup>3)</sup>
			DC	AC			5 V bus <sup>1)</sup>	+ V bus <sup>2)</sup>	
PCD2.A200	4 O, relay (make)	---	2 A/50 VDC	2 A/250 VAC	---	●	15 mA	---	L
PCD2.A210	4 O, relay (break with contact protection)	---	2 A/50 VDC	2 A/250 VAC	---	●	15 mA	---	L
PCD2.A220	6 O, relay (make with contact protection)	---	2 A/50 VDC	2 A/250 VAC	---	●	20 mA	---	L
PCD2.A250	8 O, relay (make)	---	2 A/50 VDC	2 A/48 VAC	---	●	25 mA	---	M
PCD2.A300	6 O, transistor	---	2 A/10...32 VDC	---	---	---	20 mA	---	L
PCD2.A400	8 O, transistor	---	0.5 A/5...32 VDC	---	---	---	25 mA	---	L
PCD2.A410	8 O, transistor	---	0.5 A/5...32 VDC	---	---	●	24 mA	---	L
PCD2.A460	16 O, transistor (with short circuit protection)	---	0.5 A/10...32 VDC	---	---	---	74 mA	---	O
PCD2.A465	16 O, transistor (with short circuit protection)	---	0.5 A/10...32 VDC	---	---	---	74 mA	---	N

### Digital input/output modules

Type	Number of I/Os	Input voltage	Breaking capacity		Input filter	Electrical isolation	Current draw		I/O connector type <sup>3)</sup>
			DC	AC			5 V bus <sup>1)</sup>	+ V bus <sup>2)</sup>	
PCD2.B100	2 I + 2 O + 4 selectable I or O	15...32 VDC	0.5 A/5...32 VDC	---	8 ms	---	25 mA	---	L
PCD2.B160	16 I/O (in blocks of 4 (configurable))	24 VDC	0.25 A/18...30 VDC	---	8 ms or 0.2 ms	---	120 mA	---	2× K

### Fast counter modules (only for I/O slots with fast SPI bus)

Type	Number of counters	Inputs per counter	Outputs per counter	Counting range	Selectable digital filter	Current draw		I/O connector type <sup>3)</sup>
						5 V bus <sup>1)</sup>	+ V bus <sup>2)</sup>	
PCD2.H112 <sup>4)</sup>	2	2 I + 1 configurable I	1 CCO	0...16 777 215 (24-bit)	10 kHz...150 kHz	50 mA	4 mA	K
PCD2.H114 <sup>4)</sup>	4	2 I + 1 configurable I	1 CCO	0...16 777 215 (24 bit)	10 kHz...150 kHz	50 mA	4 mA	2× K



The internal load current drawn by the I/O modules from the +5V and +V bus supply must not exceed the maximum supply current specified for the PCD2.M5xxx, PCD2.Cxxxx and PCD1.M2xxx.

### Capacity of the PCD2 controllers and module holders

Capacity	PCD1.M2xxx	PCD2.M5xxx	PCD2.C1000	PCD2.C2000
<sup>1)</sup> Internal 5V bus	500 mA	1400 mA	1400 mA	1400 mA
<sup>2)</sup> Internal +V bus 2)	200 mA	800 mA	800 mA	800 mA

The electrical requirement of the internal +5V and +V bus for the I/O modules is calculated in the PG5 2.0 Device Configurator.

<sup>3)</sup> Plug-in terminal blocks are included with I/O modules.

Spare parts are listed on the last page of this section (page 52).

Ribbon cables are not included in the scope of delivery and are listed in section 1.7 (page 78).

<sup>4)</sup> Delivery on demand



More information on counting modules, stepper motor control and positioning modules:  
Webcode scen13046

## Saia PCD2 Analog input and output modules

The numerous analog modules allow complex control tasks or measurements. Depending on the speed of the AD converter, the resolution is between 8 and 16-bit. The digitized values can be processed further directly in the project in PCD2 and PCD1. The large number of different modules means that suitable modules can be found to cover nearly every requirement.

### Analog input modules

Type/ Order no.	Total channels	Signal range	Resolution	Electrical isolation	Current draw 5 V bus <sup>1)</sup> + V bus <sup>2)</sup>		I/O connector type <sup>3)</sup>
PCD2.W200	8 I	0...+10 V	10-bit	---	8 mA	5 mA	L
PCD2.W210	8 I	0...20 mA (4...20 mA via user program)	10-bit	---	8 mA	5 mA	L
PCD2.W220	8 I	Pt 1000: -50°C...400°C/Ni 1000: -50°C...+200°C	10-bit	---	8 mA	16 mA	L
PCD2.W220Z02	8 I	NTC 10 temperature sensor	10-bit	---	8 mA	16 mA	L
PCD2.W220Z12	4 I + 4 I	4 I: 0...10 V and 4 I: Pt 1000: -50°C...400°C/Ni 1000: -50°C...+200°C	10-bit	---	8 mA	11 mA	L
PCD2.W300	8 I	0...+10 V	12-bit	---	8 mA	5 mA	L
PCD2.W310	8 I	0...20 mA (4...20 mA via user program)	12-bit	---	8 mA	5 mA	L
PCD2.W340	8 I	0...+10 V/0...20 mA (4...20 mA via user program) Pt 1000: -50°C...400°C/Ni 1000: -50°C...+200°C	12-bit	---	8 mA	20 mA	L
PCD2.W350	8 I	Pt 100: -50°C...+600°C/Ni 100: -50°C...+250°C	12-bit	---	8 mA	30 mA	L
PCD2.W360	8 I	Pt 1000: -50°C...+150°C	12-bit	---	8 mA	20 mA	L
PCD2.W380	8 I	-10 V...+10 V, -20 mA...+20 mA, Pt/Ni1000, Ni1000 L&S, NTC10k/NTC20k (configuration via user program)	13-bit	---	25 mA	25 mA	2x K
PCD2.W305	7 I	0...+10 V	12-bit	•	60 mA	0 mA	P
PCD2.W315	7 I	0...20 mA (4...20 mA via user program)	12-bit	•	60 mA	0 mA	P
PCD2.W325	7 I	-10 V...+10 V	12-bit	•	60 mA	0 mA	P
PCD2.W720	2 I	Weighing module with 2 systems for up to 6 weighing cells	≤ 18 bit	---	60 mA	100 mA	P
PCD2.W745	4 I	Temperature module for TC type J, K and 4-wire Pt/Ni 100/1000	16 bit	•	200 mA	0 mA	R

### Analog output modules

Type/ Order no.	Total channels	Signal range	Resolution	Electrical isolation	Current draw 5 V bus <sup>1)</sup> + V bus <sup>2)</sup>		I/O connector type <sup>3)</sup>
PCD2.W400	4 O	0...+10 V	8-bit	---	1 mA	30 mA	L
PCD2.W410	4 O	0...+10 V/0...20 mA/4...20 mA jumper-selectable	8-bit	---	1 mA	30 mA	L
PCD2.W600	4 O	0...+10 V	12-bit	---	4 mA	20 mA	L
PCD2.W610	4 O	0...+10 V/-10 V...+10 V/0...20 mA/4...20 mA jumper-selectable	12-bit	---	110 mA	0 mA	L
PCD2.W605	6 O	0...+10 V	10-bit	•	110 mA	0 mA	P
PCD2.W615	4 O	0...20 mA/4...20 mA, parameters can be set	10-bit	•	55 mA	0 mA	P
PCD2.W625	6 O	-10 V...+10 V	10-bit	•	110 mA	0 mA	P

### Analog input/output modules

Type/ Order no.	Total channels	Signal range	Resolution	Electrical isolation	Current draw 5 V bus <sup>1)</sup> + V bus <sup>2)</sup>		I/O connector type <sup>3)</sup>
PCD2.W525	4 I + 2 O	I: 0...10 V, 0(4)...20 mA, Pt 1000, Pt 500 or Ni 1000 (selectable by DIP switch) O: 0...10 V or 0(4)...20 mA (selectable by software)	I: 14-bit O: 12-bit	•	40 mA	0 mA	P

## Saia PCD2 mixed digital and analog input and output modules

With the multi-function I/O module PCD2.G200 a total of 24 digital and analog inputs and outputs is achieved. Thus, the need for additional module holders can be avoided, and sophisticated small applications can be implemented cost-effectively.

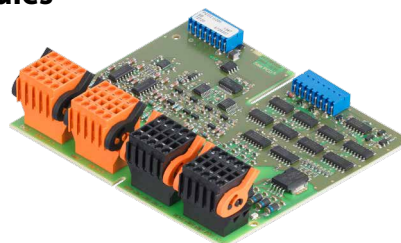

### Multifunction input/output modules

Type/ Order no.	Total channels	Signal range	Resolution	Input filter	Electrical isolation	Current draw 5 V bus <sup>1)</sup> + V bus <sup>2)</sup>		I/O connector type <sup>3)</sup>
PCD2.G200	4 I	Digital: 15...30 VDC		8 ms	---	12 mA	35 mA	KB black
	4 O	Digital: 0.5 A/10...32 VDC			---			KB black
	2 I	Analog: 0...10 V	12 bit	10 ms	---			K orange
	2 I	Analog: Pt1000 or Ni1000	12 bit	20 ms				
	4 I	Analog: universal, 0...10 V, 0...20 mA, Ni/Pt1000 (selectable by DIP switch)	12 bit	10 ms Ni/Pt 20 ms				
	8 O	Analog: 0...10 V	10 Bits		---		K orange	

<sup>1)</sup> <sup>2)</sup> <sup>3)</sup> See page 46

## Communication interfaces of the Saia PCD2.M5xxx controllers

In addition to the On-Board interfaces of Saia PCD2, the interface functions can also be extended in a modular way by means of the various slots. Numerous protocols are therefore supported by the PCD2.M5xxx series. The physical bus specifications are offered for the majority of protocols as a plug-in module. If this is not the case, the bus can be connected via an external converter.

### Protocols supported by the PCD2.M5xxx via FBoxes

- ▶ Modem communication with the PCD
- ▶ HMI editor applications with PCD7.Dxxx text terminals
- ▶ Serial S-Net (S-Bus)
- ▶ Modbus
- ▶ JCI N2-Bus
- ▶ KNX® S-Mode/EIB (with external converter)
- ▶ DALI
- ▶ EnOcean (with external converter)
- ▶ M-Bus
- ▶ BACnet®

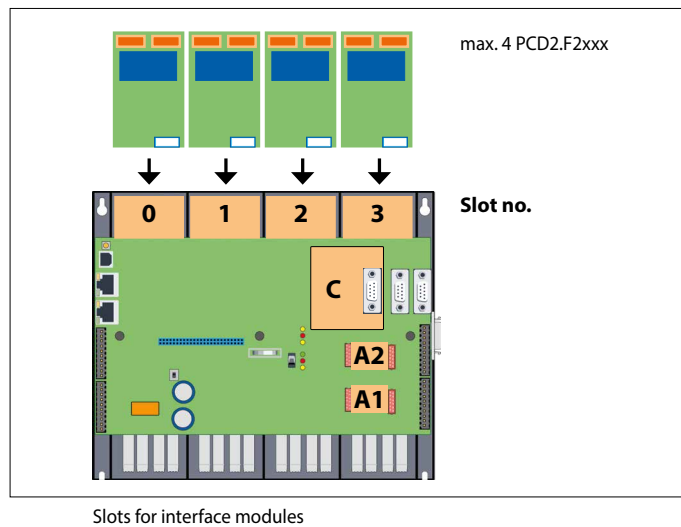
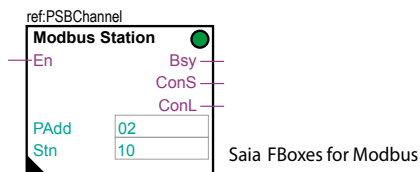

### Physical interfaces that can be freely programmed



PCD7.F150S

PCD2.F2150  
mit PCD7.F150S

Module	Specifications	Electrical isolation	Current draw		Slot	I/O connector type <sup>1)</sup>
			5 V bus	+ V bus		
PCD7.F110S	RS-422 with RTS/CTS or RS-485, with line termination resistors capable of activation.	---	40 mA	---	A1 / A2	
PCD7.F121S	RS-232 with RTS/CTS, DTR/DSR, DCD	---	15 mA	---	A1 / A2	
PCD7.F150S	RS-485 with line termination resistors capable of activation	•	130 mA	---	A1 / A2	
PCD2.F2100	RS-422 / RS-485 plus PCD7.F1xxS as option	---	110 mA	---	I/O 0-3	2x K
PCD2.F2210	RS-232 plus PCD7.F1xxS as option	---	90 mA	---	I/O 0-3	2x K

### Physical interfaces for specific protocols



PCD2.F2210



PCD2.F2150



PCD2.F2810

Module	Specifications	Electrical isolation	Current draw		Slot	I/O connector type <sup>1)</sup>
			5 V bus	+ V bus		
PCD7.F180S	Belimo MP-Bus, for connecting up to 8 drives on one line	---	15 mA	15 mA	A1 / A2	
PCD2.F2150	BACnet® MS/TP	---	110 mA	---	I/O 0-3	2x K
PCD2.F2400*	LoNWORKS®-Interface-Modul	---	90 mA	---	I/O 0-3	L9
PCD2.F2610	DALI	---	90 mA	---	I/O 0-3	L
PCD2.F2700	M-Bus 240 nodes	---	70 mA	8 mA	I/O 0-3	L
PCD2.F2710	M-Bus 20 nodes	---	70 mA	8 mA	I/O 0-3	L
PCD2.F2720	M-Bus 60 nodes	---	70 mA	8 mA	I/O 0-3	L
PCD2.F2730	M-Bus 120 nodes	---	70 mA	8 mA	I/O 0-3	L
PCD2.F2810	Belimo MP-Bus with slot for PCD7.F1xxS modules	---	90 mA	15 mA	I/O 0-3	2x K
PCD7.F7500	Profibus-DP Master	---	200 mA	---	C	
PCD2.T814	Analog modem 33.6 kbit/s (RS-232 and TTL interface)	---	250 mA	---	I/O 4 + A1	

<sup>1)</sup> Plug-in I/O terminal blocks are included with I/O modules.

Spare terminals, ribbon connectors with system cables and separate terminals are ordered as accessories (see pages 34 and 78).

\* In preparation, see section C2 Product status

### System properties of PCD2.F2xxx modules:

The following points must be observed when using the PCD2.F2xxx interface modules:

- ▶ For each PCD2 system, up to 4 PCD2.F2xxx modules (8 interfaces) can be used in slots 0...3.
- ▶ The PCD2 system has a processor to look after both the application and the serial interfaces. Processing of the interface modules requires the appropriate CPU capacity.
- ▶ To determine the maximum communication capacity for each PCD2.M5 system, consult the information and examples provided in Manual 26/856 for PCD2.M5.

## Memory modules of the Saia PCD2.M5xxx controllers

The functions of the Saia PCD2 can be expanded by means of flash memory. Memory cards with file systems and data backup are available for this. The various protocols whose firmware is installed on the flash cards can also be used by simply inserting the relevant card. The controller thus becomes BACnet® or Lon IP-enabled, for example.

More information about memory management and memory structure are listed Chapter 1.1 "Saia PCD® system description".

### System properties

#### User memory On-Board:

- ▶ 1024 kByte RAM for program + DB/text
- ▶ 2 MByte flash memory (S-RIO, configuration and backup)

#### Expansion options:

- ▶ Two slots (M1 and M2) for memory cards integrated into the CPU
- ▶ Additional SD memory cards can be inserted in the I/O slots 0 to 3 using adapters

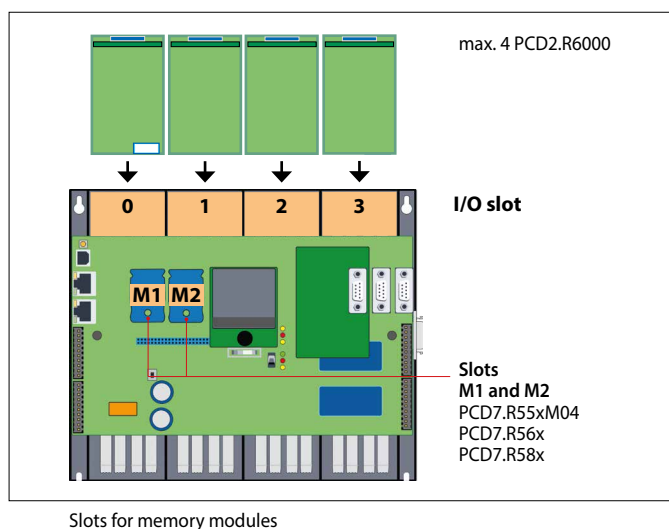

### Flash memory with file system, program and data backup, BACnet®

Type	Description	Slot
PCD7.R550M04	4 MByte flash card with file system	M1 & M2
PCD7.R560	Flash card with BACnet®	M1 & M2
PCD7.R562	Flash card with BACnet® and 128 MByte file system	M1 & M2
PCD7.R580	Flash card with Lon IP	M1 & M2
PCD7.R582	Flash card with Lon IP and 128 MByte file system	M1 & M2
PCD7.R610*	Support module for micro SD card	M1 & M2
PCD7.R-MSD1024*	SD flash micro memory card 1 GB, PCD formatted	PCD7.R610

\*) In preparation, see section C2 Product status



PCD7.R55xM04



PCD7.R610

### PCD2 SD flash memory cards for I/O slots

Type	Description	Slot
PCD2.R6000	Basic module with slot for SD flash memory cards (Up to 4 modules in I/O slots 0 to 3 on a CPU)	I/O 0-3
PCD7.R-SD512	SD flash memory card, 512 MByte with file system	---
PCD7.R-SD1024	SD flash memory card, 1024 MByte with file system	---

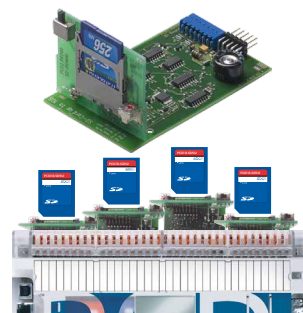

### Battery for data backup

Type	Description
4 507 4817 0	Lithium battery for PCD processor unit (RENATA button battery type CR 2032)



### System properties of PCD7.R5xx modules

- ▶ Only 1 BACnet® or Lon IP module can be run for each PCD2.M5xxx.



## Saia PCD7.D3100E Integral e-display

With the Saia PCD7.D3100E, Saia has expanded the concept of “seamless control”, which has only one HMI project for all devices from the small control unit to any device with a browser (Explorer, Mozilla, etc.), to include on-site display of the automation device. This is a new way of having on-site automation device control available anywhere in the network on the PC or PDA. The web project is created with Saia Web Editor for Micro-Browser and Microsoft® Explorer applications.

### System properties

- ▶ Graphical display can be integrated directly in PCD2.Mxxxx
- ▶ 4 grey shades
- ▶ Resolution of 128 × 88 pixels
- ▶ LED backlighting
- ▶ Display size of 35.8 × 24.8 mm
- ▶ Dimensions of 47 × 67 mm
- ▶ Joystick for navigation
- ▶ Functionality: Sub-set of a Micro-Browser

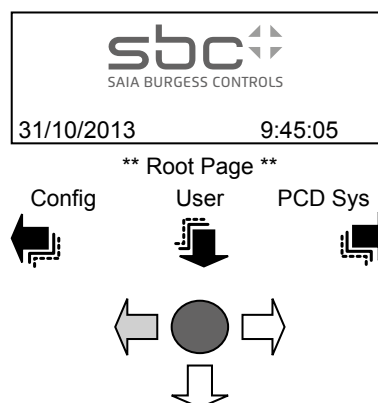

### Predefined configuration units

Together with the possibility of editing user defined projects with Saia Web Editor (version for e-display), a variety of predefined configuration screens for e-display and the PCD system are also available to the user. This makes it easy to implement initial on-site diagnosis and control.

### PCD2.M5xxx: Parameters that can be edited and are displayed

- ▶ CPU type and serial number
- ▶ HW version
- ▶ FW version
- ▶ MAC address
- ▶ Program name
- ▶ TCP/IP parameters
- ▶ S-Bus address
- ▶ PCD status, time and date

### Configurable display functions

- ▶ User start page
- ▶ Setup timeout
- ▶ Backlighting timeout
- ▶ Contrast
- ▶ Inactivity timeout
- ▶ Sleep timeout
- ▶ Sleep refresh time

### Operation

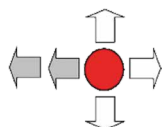

5 way button use for configuration, editing user projects and for PCD system settings, such as CPU type, date and time, TCP/ IP address, etc.

### Assembly



Insert, fix in place and you're done!

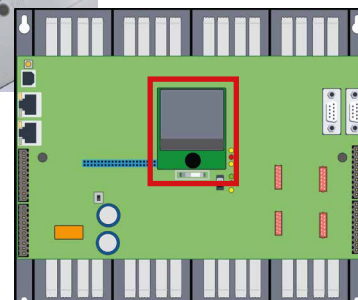



## Accessories and consumables for the Saia PCD2.M5xxx controllers

### Fast labeling of I/O modules with Saia LabelEditor

The software tool is used to efficiently label the PCD2 labeling strip. The unique data point text can be entered in the tool by the user. In the tool, the unique data point text to be entered by the user. These can then be printed on A4 paper. For the different types of PCD2 modules, the user selects appropriate distance formats. The entered text can be saved as templates and reused.

SBC Label Editor is supplied with Saia PG5 Controls Suite.

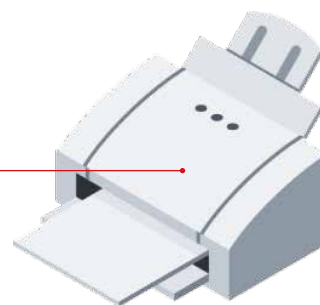
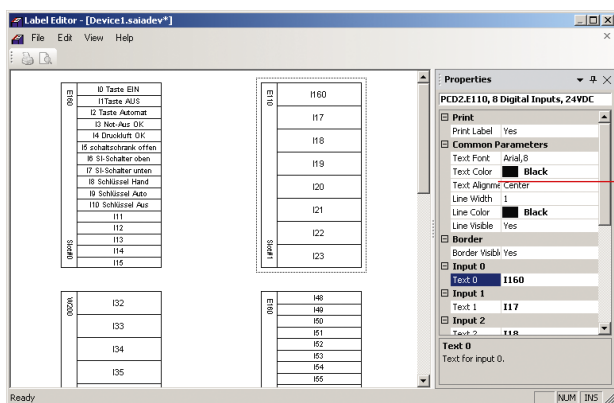
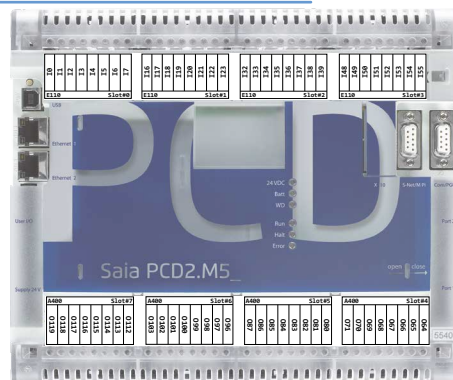

### EPLAN macros

For project planning and engineering EPLAN macros are available



ePLAN® electric P8 macros are available from the support page.

Macros and product data may also be obtained from the ePLAN® data portal.



1 Automation stations

2 HMI Visualization and operating

3 Dedicated room controller

4 Consumption data acquisition

5 Cabinet components

## Consumables and accessories for Saia PCD2 controllers

### Saia PCD2 housing covers



Type	Description
4 104 7719 0	Cover for PCD2.M5x40 without logo (neutral housing cover)
4 104 7758 0	Cover for PCD2.C1000 without logo (neutral housing cover)
4 104 7720 0	Cover for PCD2.C2000 without logo (neutral housing cover)

### Saia PCD2 plug-in screw terminal blocks for On-Board I/Os



Type	Description
4 405 4916 0	Plug-in screw terminal block, 10-pin, labeling 0...9
4 405 4917 0	Plug-in screw terminal block, 10-pin, labeling 10...19
4 405 4918 0	Plug-in screw terminal block, 10-pin, labeling 20...29
4 405 4919 0	Plug-in screw terminal block, 10-pin, labeling 30...39
4 405 4920 0	Plug-in screw terminal block, 10-pin, labeling 40...49

### Plug-in screw terminal blocks and connectors for Saia PCD2 I/O modules



Type	Description
4 405 5109 0	Plug-in screw terminal block, 9-pin for PCD2.F2400, for wires up to 1,5 mm <sup>2</sup>
4 405 4847 0	Plug-in screw terminal block, 10-pin (type L) for wires up to 1,5 mm <sup>2</sup> , labeling 0...9
4 405 4869 0	Plug-in screw terminal block, 14-pin (type M) for wires up to 0,6 mm <sup>2</sup>
4 405 5048 0	Plug-in spring terminal block 2 × 5-pin (type K) for wires up to 1,0 mm <sup>2</sup> , orange
4 405 5054 0	Plug-in spring terminal block 2 × 5-pin (type K) for wires up to 1,0 mm <sup>2</sup> , black

### I/O bus connection



Type	Description
PCD2.K010	I/O bus connector
PCD2.K106	I/O bus extension cable

### Battery



Type	Description
4 507 4817 0	Lithium battery for PCD2.M5xxx

### System cables for digital modules with 16 I/Os<sup>1)</sup>

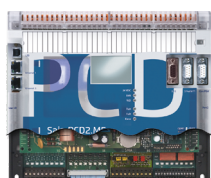

PCD2.K221	Sheathed, round cable with 32 strands, each 0.25 mm <sup>2</sup> , 1.5 m long, PCD side: 34-pin ribbon connector type D, process side: strand ends free, color coded
PCD2.K223	Sheathed, round cable with 32 strands, each 0.25 mm <sup>2</sup> , 3.0 m long, PCD side: 34-pin ribbon connector type D, process side: strand ends free, color coded

### System cables for adapters PCD2.K520/...K521/...K525<sup>1)</sup>

PCD2.K231	Sheathed, half-round cable with 34 strands, each 0.09 mm <sup>2</sup> , 1.0 m long, with 34-pin ribbon connector type D at both ends
PCD2.K232	Sheathed, half-round cable with 34 strands, each 0.09 mm <sup>2</sup> , 2.0 m long, with 34-pin ribbon connector type D at both ends

### System cables for 2 adapters PCD2.K510/...K511 or 1 adapter and relay interface PCD2.K551<sup>1)</sup>

PCD2.K241	Sheathed, half-round cable with 34 strands, each 0.09 mm <sup>2</sup> , 1.0 m long, PCD side: 34-pin ribbon connector type D, process side: two 16-pin ribbon connectors
PCD2.K242	Sheathed, half-round cable with 34 strands, each 0.09 mm <sup>2</sup> , 2.0 m long, PCD side: 34-pin ribbon connector type D, process side: two 16-pin ribbon connectors

### "Ribbon connector ↔ screw terminal" adapters

PCD2.K510	for 8 inputs/outputs, with 20 screw terminals, without LED
PCD2.K511	for 8 inputs/outputs, with 20 screw terminals and LED (for source operation only)
PCD2.K520	for 16 inputs/outputs, with 20 screw terminals, without LED
PCD2.K521	for 16 inputs/outputs, with 20 screw terminals and LED (for source operation only)
PCD2.K525	for 16 inputs/outputs, with 3 × 16 screw terminals and LED (for source operation only)
PCD2.K551	Relay interface for 8 PCD transistor outputs with 24 screw terminals and LED
PCD2.K552	Relay interface PCD2.K552 for 8 PCD transistor outputs with 24 screw terminals, LED and manual control mode (switch on-off-auto) and 1 output as feedback for the manual control mode

<sup>1)</sup> For details, see Section 1.7



## 1.4 Saia PCD1

The Saia PCD1 systems are the smallest programmable Saia PCD® controllers in a flat design. Alongside the standard communication interfaces, integrated data memory and web/IT functionality, all controllers also have at least 18 integrated I/Os. The PCD1 controllers are ideally suited to small-scale automation tasks, whose challenges and issues can be successfully mastered by the powerful CPU.

The many communication options are another advantage:

Ethernet TCP/IP, USB port, the onboard RS-485 interface and the expansion options with BACnet® or Lon IP, for instance, are a small example of the performance capability of PCD1.

### 1.4.1 Saia PCD1.M2 series

Page 54



**Saia PCD1.M2xxx** are compact and may be modular extended.

**Types:**

- ▶ PCD1.M2160 with Ethernet TCP/IP and expanded memory
- ▶ PCD1.M2120 with Ethernet TCP/IP
- ▶ PCD1.M2020 without Ethernet TCP/IP

18 integrated I/Os  
2 free I/O slots



Possible use in primary switch cabinet

### 1.4.2 Saia PCD1.Room (PCD1.M2110R1)

Page 58

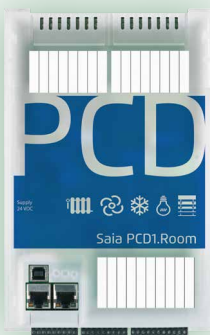

**Saia PCD1.Room** is for applications in the field of room automation and HeaVAC.

**Type:**

- ▶ PCD1.M2110R1 with Ethernet TCP/IP for room automation applications

24 integrated I/O  
1 free I/O slot

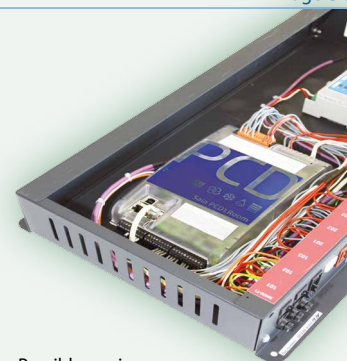

Possible use in a room (Example in a Room Box)

### 1.4.3 Saia PCD® E-Controller (PCD1.M0160E0)

Page 62



E-Controller for installation in electrical cabinet. In the default setup, there are S-Monitoring (energy) functionalities that can be adjusted with Saia PG5.

**Type:**

- ▶ PCD1.M0160E0 with S-Monitoring function

18 integrated I/Os  
no free I/O slots



Possible use in a electrical cabinet

## 1.4.1 Saia PCD1.M2xxx

The Saia PCD1.M2xxx series is a compact controller with onboard I/Os and in addition two I/O-slots for PCD2 I/O-modules or communication interface-modules. The Web/IT functionality, the onboard memory, the range of standard communication interfaces and the expansion options offer good solutions for small to medium installations.



### Layout

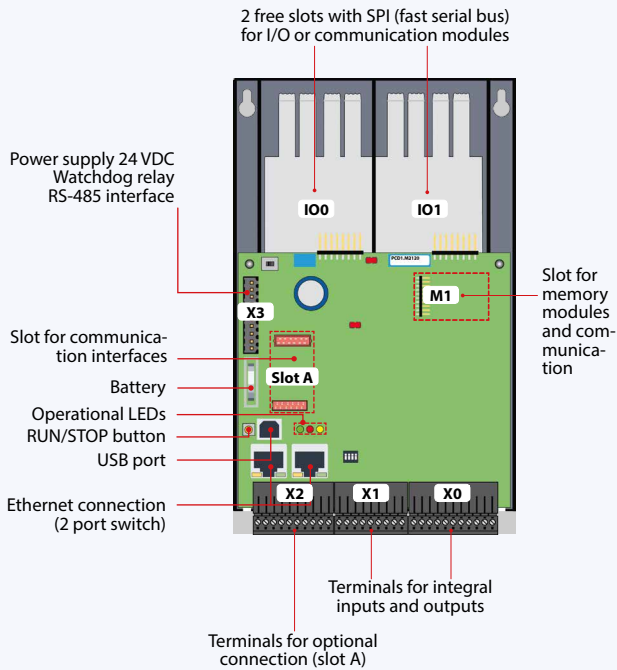

### System characteristics

- ▶ Up to 50 inputs / outputs may be expanded locally with RIO PCD3.T66x or PCD3.T76x
- ▶ Up to 8 communication interfaces
- ▶ USB and Ethernet interface onboard
- ▶ Large onboard memory for programs (up to 1 MByte) and data (up to 128 MByte file system)
- ▶ Automation Server for integration into Web/IT systems



### Types

- ▶ PCD1.M2160 with Ethernet TCP/IP and expanded memory
- ▶ PCD1.M2120 with Ethernet TCP/IP
- ▶ PCD1.M2020 without Ethernet TCP/IP

### Mounting

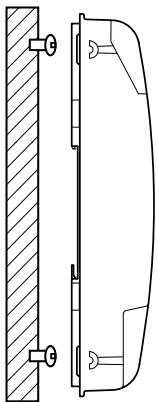

On a flat surface

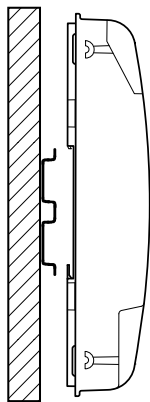

On two top-hat rails  
(2 × 35 mm pursuant to  
DIN EN 60 715 TH35)

### Dimensions

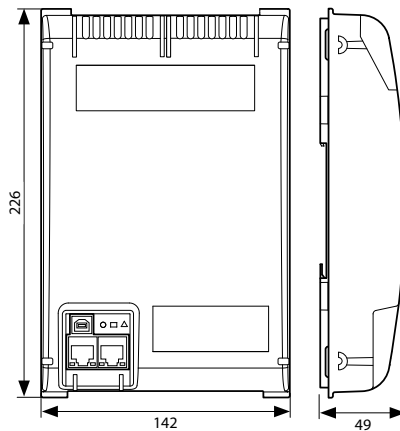

### Power supply and connection plan

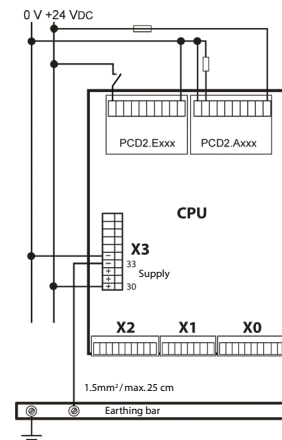

Further information is provided in the Saia PCD3 power supply and connection plan section and in Manual 26-875.

## Overview of Saia PCD1.M2xxx

### Technical data

Memory and file system	Types:			
		PCD1.M2160	PCD1.M2120	PCD1.M2020
Program memory, DB/text (Flash)		1 MByte	512 kByte	512 kByte
User memory, DB/text (RAM)		1 MByte	128 kByte	128 kByte
User flash file system onboard		128 MByte	8 MByte	8 MByte

### Integrated communication

Ethernet connection (2 port switch) 10/100 Mbit/s, full-duplex, auto-sensing, auto-crossing	yes	yes	no
USB connection USB 1.1 device, 12 Mbit/s	yes	yes	yes
RS-485 (terminal X3), up to 115 kbit/s	yes	yes	yes

### General data

Supply voltage	24 VDC, -20/+25 % max. incl. 5% ripple (according to EN/IEC 61131-2)
Battery for data backup (exchangeable)	Lithium battery with a service life of 1 to 3 years
Operating temperature	0...55 °C
Dimensions (W × H × D)	142 × 226 × 49 mm
Type of mounting	2× top-hat rails according to DIN EN60715 TH35 (2 × 35 mm) or on a flat surface
Protection level	IP 20
Capacity 5V/+V(24V) internal	max. 500 mA/200 mA
Power consumption	typically 12 W

### On-Board inputs/outputs

#### Inputs

6 Digital inputs (4 + 2 interrupts)	15...30 VDC, 8 ms input filter (0.2 ms for the interrupts)	Terminal X1
2 Analog inputs, selectable via DIP switch	-10...+10 VDC, 0...+/-20 mA, Pt1000, Ni1000, Ni1000 L&S, 0...2.5 kΩ, 12 bit resolution	Terminal X1

#### Outputs

4 Digital outputs	24 VDC / 0.5 A	Terminal X0
1 PWM output	24 VDC / 0.2 A	Terminal X0

#### selectable/configurable via PG5

4 Digital inputs or outputs	24 VDC / data as digital inputs resp. outputs	Terminal X0
1 Watchdog relay or make contact	48 VAC or VDC, 1 A mount a free wheeling diode over the load when switching DC-tension	Terminal X3

### Analogue output module Saia PCD7.W600 \*)

This new analogue outputs (range 0 to +10 V) with 12 bits resolution has been especially developed for the new PCD1 CPU (PCD1.M2xxx, PCD1.M0160E0, PCD1.M2110R1). It can be plugged in the slot A instead of a communication interface.

\*) In preparation, see section C2 Product status

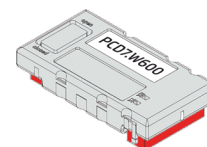

### Plug-in I/O modules for slots I/O 0 and I/O 1

The modules that have already been listed in the PCD2.M5 series are used for the Saia PCD1 series.





## Saia PCD1.M2xxx interface options

In addition to the onboard interfaces, the interface functions can also be extended in a modular way by means of the various slots. Numerous protocols are therefore supported by the Saia PCD1.M2 series. Detailed information and an overview can be found in the section BA communication systems.

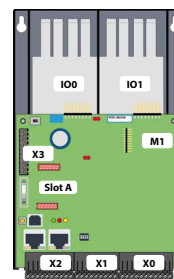

Communication		Electrical isolation	Internal current draw 5V +V (24V)		Slot	I/O connector type <sup>1)</sup>
PCD7.F110S	RS-485/RS-422	---	40 mA	-	Slot A	
PCD7.F121S	RS-232 with RTC/CTS, DTR/DSR, DCD suitable for modem, EIB connection	---	15 mA	-	Slot A	
PCD7.F150S	RS-485 with activatable termination resistors	•	130 mA	-	Slot A	
PCD7.F180S	Belimo MP-Bus, for connecting up to 8 drives on one line	---	15 mA	15 mA	Slot A	
PCD2.F2100	RS-422/RS-485 plus PCD7.F1xxS as option	---	110 mA	-	IO 0/1	2x K
PCD2.F2150	BACnet® MS/TP RS-485 plus PCD7.F1xxS as option	---	110 mA	-	IO 0/1	2x K
PCD2.F2210	RS-232 plus PCD7.F1xxS as option	---	90 mA	-	IO 0/1	2x K
PCD2.F2400*	LONWORKS®-Interface-Modul	---	90 mA	-	IO 0/1	L9
PCD2.F2610	DALI master for up to 64 DALI-devices	---	90 mA	-	IO 0/1	L
PCD2.F27x0	M-Bus master with 2 M-Bus interfaces	---	70 mA	8 mA	IO 0/1	L
PCD2.F2810	Belimo MP-Bus plus PCD7.F1xxS as option	---	90 mA	15 mA	IO 0/1	2x K

<sup>1)</sup> Plug-in I/O terminal blocks are included with I/O modules.

Spare terminals, ribbon connectors with system cables and separate terminals are ordered as accessories (see pages 34, 52 and 78).

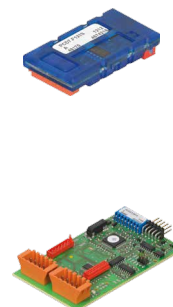

The use of external modem modules such as Q.M716-KS1 is recommended.

The PCD2.T8xx modem modules can only be used together with a PCD7.F121S module. External wiring is therefore required.

### System properties of PCD2.F2xxx modules

The following points must be observed when using the PCD2.F2xxx interface modules:

- ▶ For each PCD1.M2 system, up to 2 PCD2.F2xxx modules (4 interfaces) can be used in slots I/O 0/1.
- ▶ To determine the maximum communication capacity for each PCD1.M2 system, consult the information and examples provided in Manual 26/875 for PCD1.M2.

## Memory modules

The onboard memory of the Saia PCD1.M2xxx can be extended by means of a Saia PCD7.Rxxx module in slot M1. In addition, the Saia PCD1.M21x0 can be extended with BACnet® IP or LON IP.

More information about the memory management and construction are listed in Chapter 1.1 Saia PCD® basic properties.

### Memory extension and communication

PCD7.R550M04	Flash memory module with 4 MByte file system (for user program backup, web pages, etc.)	M1
PCD7.R560	Flash memory module for BACnet® firmware	M1
PCD7.R562	Flash memory module for BACnet® firmware with 128 MByte file system	M1
PCD7.R580	Flash memory module for LON IP firmware	M1
PCD7.R582	Flash memory module for LON IP firmware with 128 MByte file system	M1
PCD7.R610*	Base module for Micro SD Flash Card	M1
PCD7.R-MSD1024*	Micro SD Flash Card 1024 MB, PCD formatted	PCD7.R610

\* In preparation, see section C2 Product status



PCD7.R55xM04

PCD7.R610





## Accessories and consumables for Saia PCD1.M2xxx

### Labeling

The self-adhesive labels can be printed directly with the SBC LabelEditor from the PG5 Device Configurator

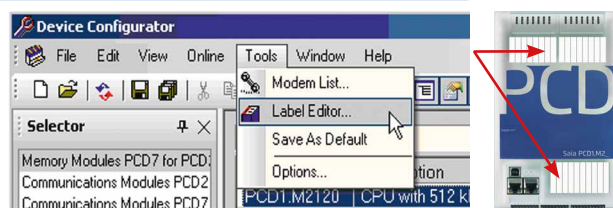

### EPLAN macros

For project planning and engineering EPLAN macros are available.



ePLAN® electric P8 macros are available from the support page.

Macros and product data may also be obtained from the ePLAN® data portal.



### Battery for data backup

Type	Description
4 507 4817 0	Lithium battery for PCD processor unit (RENATA button battery type CR 2032)



### Plug-in screw terminal blocks

4 405 5089 0	Plug-in screw terminal block, 11-pole, labeling 0...10	Terminal X0
4 405 5087 0	Plug-in screw terminal block, 9-pole, labeling 11...19	Terminal X1
4 405 5088 0	Plug-in screw terminal block, 10-pole, labeling 20...29	Terminal X2
4 405 4919 0	Plug-in screw terminal block, 10-pole, labeling 30...39	Terminal X3



### Cover

4 104 7759 0	Housing cover for PCD1.M2xxx without logo can be individually designed on site with a foil
--------------	--



## Range of uses

- ▶ For small and medium installations
- ▶ Modernization and enhancement of existing installations through the compact design, for example
- ▶ Various interface options, including to existing installations as a gateway.  
For example, optimization of a cooling system by setting all the free parameters

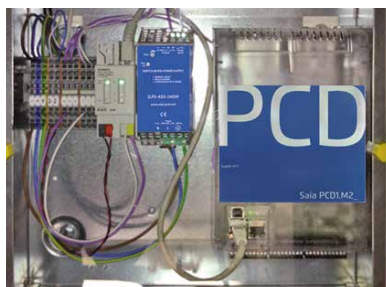

Connection to an existing EIB/KNX installation providing conference rooms with a web connection



Use as communication interface with M-Bus in a district heating network

## 1.4.2 Saia PCD1.Room (PCD1.M2110R1)

Saia PCD1.Room (PCD1.M2110R1) is a programmable room controller for sophisticated solutions with many communication options. In addition to the I/Os that are already integrated, the controller offers a free I/O slot for an individual expansion with inputs/outputs or communication options. Web/IT functions for mobile operation, for instance, are also already onboard.

Furthermore, Saia PCD1.Room offers various possibilities for integrating other systems in the room through standard communication interfaces. (Energy) efficient and individual room automation can be easily implemented as a result.

The controller also provides a good basis for achieving the energy efficiency classes according to EN 15232:2012.



### Layout with connection example

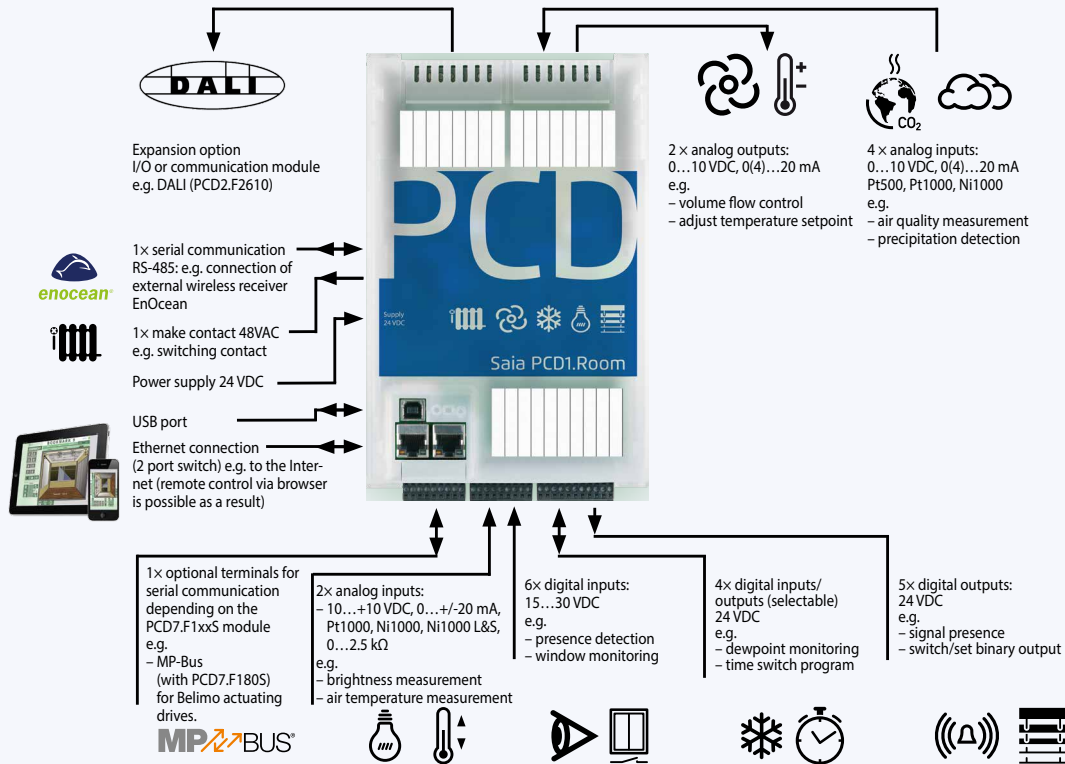

Lighting, sun blinds and single room control can be optimally harmonized with this controller. This example showing possible assignments was compiled on the basis of applications according to the VDI 3813 list of room automation functions and the DIN EN 15232 list of building automation functions.



The Smart RIO Manager function is not supported!

### Mounting

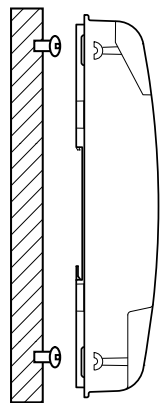

On a flat surface

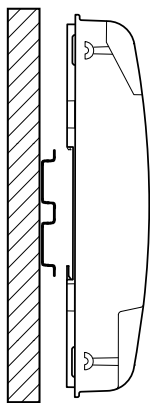

On two top-hat rails  
(2 x 35 mm pursuant to  
DIN EN 60 715 TH35)

### Dimensions

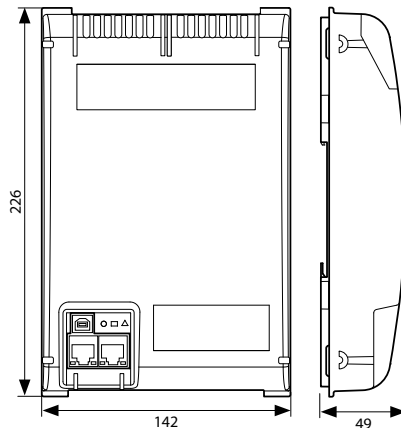

### Power supply and connection plan

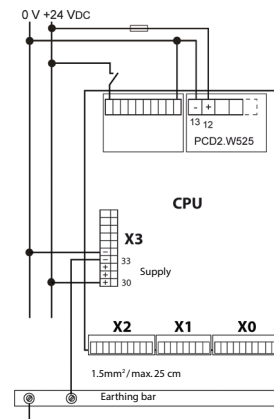

Further information is provided in the Saia PCD3 power supply and connection plan section and in Manual 26-875.

## Overview of Saia PCD1.Room (PCD1.M2110R1)

### Technical data

Memory and file system	Type:	PCD1.M2110R1
Program memory, DB/text (Flash)		256 kByte
User memory, DB/text (Flash)		128 kByte
User flash file system onboard		8 MByte
<b>Integrated communication</b>		
Ethernet connection (2 port switch) 10/100 Mbit/s, full-duplex, auto-sensing, auto-crossing		yes
USB connection USB 1.1 device, 12 Mbit/s		yes
RS-485 (terminal X3), up to 115 kbit/s		yes

### General data

Supply voltage	24 VDC, -20/+25 % max. incl. 5% ripple (according to EN/IEC 61131-2)
Battery for data backup (exchangeable)	Lithium battery with a service life of 1 to 3 years
Operating temperature	0...55 °C
Dimensions (W×H×D)	142 × 226 × 49 mm
Type of Mounting	2× top-hat rails according to DIN EN60715 TH35 (2 × 35 mm) or on a smooth surface
Protection type	IP 20
Capacity 5V/+V(24V) internal	max. 500 mA/200 mA
Power consumption	typically 12 W
Automation Server	Flash memory, Filesystem, FTP and Web-Server, E-Mail, SNMP



### On-Board inputs/outputs

#### Inputs

6 Digital inputs (4 + 2 interrupts)	15...30 VDC, 8 ms / 0.2 ms input filter	Terminal X1
2 Analog inputs, selectable via DIP switch	-10...+10 VDC, 0...+/-20 mA, Pt1000, Ni1000, Ni1000 L&S, 0...2.5 kΩ, 12 Bit resolution	Terminal X1
4 Analog inputs, selectable via DIP switch	0...10 VDC, 0(4)...20 mA, Pt1000, Pt 500, Ni1000 14 Bit resolution	EA 1

#### Outputs

4 Digital outputs	24 VDC / 0.5 A	Terminal X0
1 PWM output	24 VDC / 0.2 A	Terminal X0
2 Analog outputs, selectable via PG5	0...10 VDC or 0(4)...20 mA, 12 Bit resolution	EA 1

#### Selectable/configurable via PG5

4 Digital inputs or outputs	24 VDC / data as digital inputs resp. outputs	Terminal X0
1 Watchdog relay or as make contact	48 VAC or VDC, 1 A mount a free wheeling diode over the load when switching DC-tension	Terminal X3

### Analogue output module Saia PCD7.W600 \*)

This new analogue outputs (range 0 to +10 V) with 12 bits resolution has been especially developed for the new PCD1 CPU (PCD1.M2xxx, PCD1.M0160E0, PCD1.M2110R1 ). It can be plugged in the slot A instead of a communication interface.

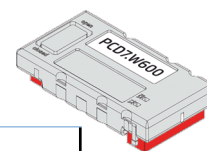

\*) In preparation, see section C2 Product status

### Plug-in I/O modules for slot I/O 0

The modules that have already been listed in the PCD2.M5 series are used for the Saia PCD1 series.



! Only a PCD2.W525 module that is already supplied together with the controller in the default set up works in slot I/O 1. If the module is removed, the controller stops.

## Saia PCD1.Room (PCD1.M2110R1) interface options

In addition to the onboard interfaces, the interface functions can also be extended in a modular way by means of the various slots. Numerous protocols are therefore supported by the Saia PCD1.M2110R1.

A detailed list of all the protocols can be found in the section BA communication systems.

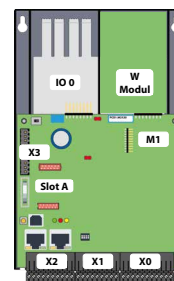

Communication		Electrical isolation	Internal current draw 5V +V (24V)		Slot	I/O connector type <sup>1)</sup>
PCD7.F110S	RS-485/RS-422 not electrically isolated	---	40 mA	-	Slot A	
PCD7.F121S	RS-232 with RTC/CTS, DTR/DSR, DCD suitable for modem, EIB connection	---	15 mA	-	Slot A	
PCD7.F150S	RS-485 electrically isolated, with activatable termination resistors	•	130 mA	-	Slot A	
PCD7.F180S	Belimo MP-Bus, for connecting up to 8 drives on one line	---	15 mA	15 mA	Slot A	
PCD2.F2100	RS-422/RS-485 (not electrically isolated) plus PCD7.F1xxS as option	---	110 mA	-	IO 0/1	2x K
PCD2.F2150	BACnet® MS/TP RS-485 plus PCD7.F1xxS as option	---	110 mA	-	IO 0/1	2x K
PCD2.F2210	RS-232 plus PCD7.F1xxS as option	---	90 mA	-	IO 0/1	2x K
PCD2.F2400*	LONWORKS®-Interface-Modul	---	90 mA	-	IO 0/1	L9
PCD2.F2610	DALI master for up to 64 DALI-devices	---	90 mA	-	IO 0/1	L
PCD2.F27x0	M-Bus master with 2 M-Bus interfaces	---	70 mA	8 mA	IO 0/1	L
PCD2.F2810	Belimo MP-Bus plus PCD7.F1xxS as option	---	90 mA	15 mA	IO 0/1	2x K

<sup>1)</sup> Plug-in I/O terminal blocks are included with I/O modules.

Spare terminals, ribbon connectors with system cables and separate terminals are ordered as accessories (see pages 34, 52 and 78).



### System properties of PCD2.F2xxx modules

The following points must be observed when using the PCD2.F2xxx interface modules:

- ▶ For each PCD1.M2120R1 Room Edition, up to 1 PCD2.F2xxx module (2 interfaces) can be used in slot I/O 0.
- ▶ To determine the maximum communication capacity for each PCD1.M2 system, consult the information and examples provided in Manual 27/619 für PCD1.M2110R1.

## Memory modules

The onboard memory can be extended by means of a PCD7.Rxxx module in slot M1. In addition, BACnet® IP or LON IP can be activated.

For more information about memory management and construction, see Chapter 1.1 Saia PCD® System description.

### Memory extension and communication

PCD7.R550M04	Flash memory module with 4 MByte file system (for user program backup, web pages, etc.)	M1
PCD7.R560	Flash memory module for BACnet® firmware	M1
PCD7.R562	Flash memory module for BACnet® firmware with 128 MByte file system	M1
PCD7.R580	Flash memory module for LON IP firmware	M1
PCD7.R582	Flash memory module for LON IP firmware with 128 MByte file system	M1
PCD7.R610*	Base module for Micro SD Flash Card	M1
PCD7.R-MSD1024*	Micro SD Flash Card 1024 MB, PCD formatted	PCD7.R610

\* In preparation, see section C2 Product status



PCD7.R55xM04

PCD7.R610



## Accessories and consumables for Saia PCD1.Room (PCD1.M2110R1)

### Labeling

The self-adhesive labels can be printed directly with the SBC LabelEditor from the PG5 Device Configurator

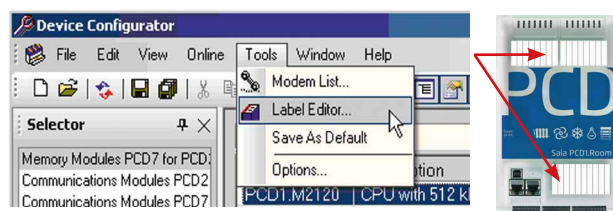

### EPLAN macros

For project planning and engineering EPLAN macros are available



ePLAN® electric P8 macros are available from the support page.

Macros and product data may also be obtained from the ePLAN® data portal.



### Battery for data backup

Type	Description
4 507 4817 0	Lithium battery for PCD processor unit (RENATA button battery type CR 2032)



### Plug-in screw terminal blocks

4 405 5089 0	Plug-in screw terminal block, 11-pole, labeling 0...10	Terminal X0
4 405 5087 0	Plug-in screw terminal block, 9-pole, labeling 11...19	Terminal X1
4 405 5088 0	Plug-in screw terminal block, 10-pole, labeling 20...29	Terminal X2



### Cover

4 104 7759 0	Housing cover for PCD1.M2xxx without SBC-Logo can be individually designed on site with a foil
--------------	--



## Range of uses

### Applications

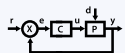

#### Options for programmable applications:



▶ Radiators



▶ Fan-coil applications



▶ Cooling ceiling



▶ VAV – variable air volume



▶ Air quality control



▶ Signal contacts (occupancy control, presence detection, window monitoring)



▶ Lighting control



▶ Blind control

▶ etc.

### Room control units



#### Connection options via the following:

▶ Analog signals (onboard)

▶ S-Bus (onboard)

▶ Modbus (onboard)

▶ Internet access, web server (onboard)

▶ BACnet® with PCD7.R56x (slot M1)

▶ BACnet® MS/TP with PCD2.F2150\* (slot I/O 0)

▶ LON IP with PCD7.R58x (slot M1)

▶ LON FTT 10 with PCD2.F2400 \* (slot I/O 0)

▶ KNX over IP (IP onboard)

▶ KNX TP with an external coupler

▶ EnOcean with external receiver

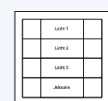
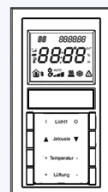

Applications should be examined closely taking account of the number of I/Os. Depending on the application, coupling relays (for example: PCD7.L252) or S-Bus RIOs (PCD7.L200/L210) may be required. The S-Bus and Modbus stations are limited to a maximum of 10 units.

\* In preparation, see chapter C2 "Product status"

### 1.4.3 Saia PCD1.M0160E0 E-Controller

The freely programmable E-Controller (PCD1.M0160E0) is a compact controller with a factory pre-loaded S-Monitoring application. For more about S-Monitoring and the loaded application, see below under Chapter 4 „S-Monitoring“, section 4.8 „E-Controller“. Designed for compatibility with an electrical control box, the E-Controller is suitable for installation in a power distribution unit or any restricted space. In addition to integral I/Os, interfaces and web/IT functions, the PCD1.M0160E0 offers further ways of connecting various protocols. This controller is therefore ideal as a micro-controller or communications gateway (e.g. EnOcean, KNX, BACnet ...) or for acquiring, logging and processing consumption data.



#### Layout

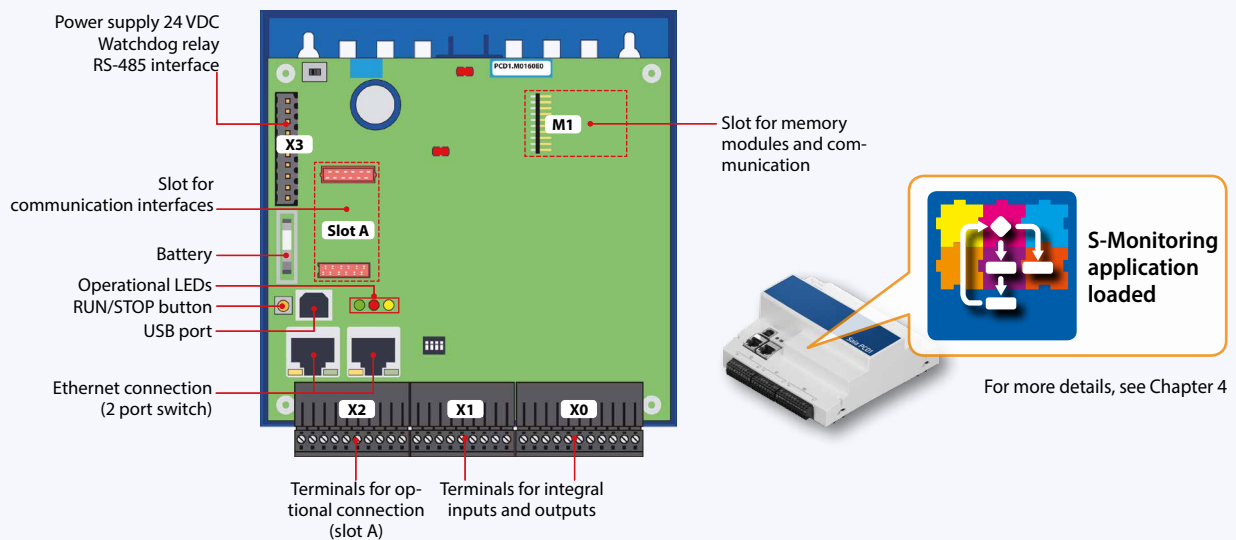

#### Mounting

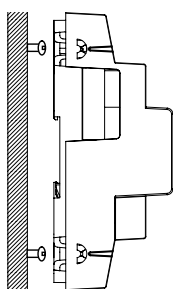

on a flat surface

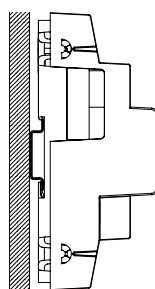

on top-hat rail  
(35 mm according to  
DIN EN 60 715 TH35)

#### Dimensions

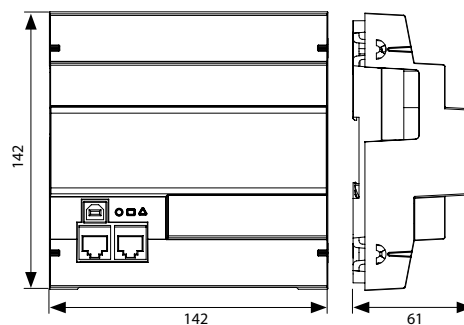

#### Power supply & connection plan

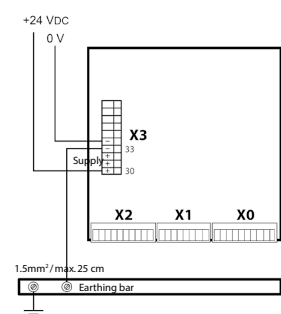

Further information is provided in the Saia PCD3 power supply and connection plan section and in Manual 26-875.



## Overview Saia PCD® E-Controller (PCD1.M0160E0)

### Technical data

### PCD1.M0160E0

Memory and file system	
Program memory, DB/text (Flash)	1 MByte
Working memory, DB/text (RAM)	1 MByte
User flash file system onboard	128 MByte
Integral communication	
Ethernet connection (2 port switch) 10/100 Mbit/s, full duplex, autosensing, auto-crossing	yes
USB connection USB 1.1 device 12 Mbit/s	yes
RS-485 (terminal X3) up to 115 kbit/s	yes

### General data

Supply voltage	24 VDC, -20/+25% max. incl. 5% ripple (in accordance with EN/IEC 61131-2)
Battery for data backup (exchangeable)	Lithium battery with a service life of 1 to 3 years
Operating temperature	0...55 °C
Dimensions (W×H×D)	142 × 142 × 60 mm
Type of Mounting	Top-hat rail according to DIN EN60715 TH35 (1 × 35 mm) or on a flat surface
Protection type	IP 20
Capacity 5V/+V(24V) internal	max. 500 mA/200 mA
Power consumption	typically 12 W
Automation Server	Flash memory, Filesystem, FTP and Web-Server, E-Mail, SNMP

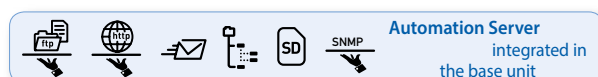

### On-Board inputs/outputs

#### Inputs

6	Digital inputs (4 + 2 interrupts)	15...30 VDC, 8 ms / 0,2 ms input filter	Terminal X1
2	Analog inputs, selectable via DIP switch, preconfigured for Ni1000 in the default setup	-10...+10 VDC, 0...+/-20 mA, Pt1000, Ni1000, Ni1000 L&S, 0...2.5 kΩ	Terminal X1

#### Outputs

4	Digital outputs	24 VDC	Terminal X0
1	PWM output	24 VDC / 0.2 A	Terminal X0

selectable/configurable via PG5

4	Digital inputs or outputs, preconfigured for digital inputs in the default setup	24 VDC / data as digital inputs resp. outputs	Terminal X0
1	Watchdog relay or as make contact	48 VAC or VDC, 1 A mount a free wheeling diode over the load when switching DC-tension	Terminal X3

### Analogue output module Saia PCD7.W600 \*)

This new analogue outputs (range 0 to +10 V) with 12 bits resolution has been especially developed for the new PCD1 CPU (PCD1.M2xxx, PCD1.M0160E0, PCD1.M2110R1). It can be plugged in the slot A instead of a communication interface.

\*) In preparation, see section C2 Product status

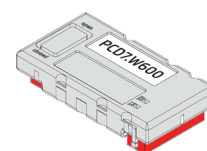

## Installation instructions and recommendations

### Mounting in electrical cabinet

The Saia PCD1.M0160E0 is sized 142 × 142 × 60 mm, excluding terminals and connectors.

For proper installation, a space of 55 mm should be left above the DIN rail and 75 mm below it.

### Ethernet cable

For installation in the sub electrical cabinet unit, angled or flexible network cable (e.g. SlimWire PRO) is recommended.

If conventional network cable is installed, mounting of the sub electrical cabinet cover cannot be guaranteed.

## Interface options Saia PCD® E-Controller (PCD1.M0160E0)

In addition to the onboard interfaces, modular expansion of interface functions is possible at slot A. For this purpose, the Saia PCD1.M0160E0 supports numerous protocols. A detailed list of all protocols find in chapter B2 „Communication & Interaction“.

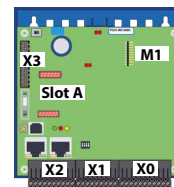

Communication		Current consumption at 5V bus	Current consumption at +V bus (24 V)	
PCD7.F110S	RS-485/RS-422 not electrically isolated	40 mA	---	Slot A
PCD7.F121S	RS-232 with RTC/CTS, DTR/DSR, DCD suitable for modem or EIB connection	15 mA	---	Slot A
PCD7.F150S	RS-485 electrically isolated, with activatable termination resistors	130 mA	---	Slot A
PCD7.F180S	Belimo MP-Bus, for connecting up to 8 drives on one line	15 mA	15 mA	Slot A

### Connection example: M-Bus with external interface

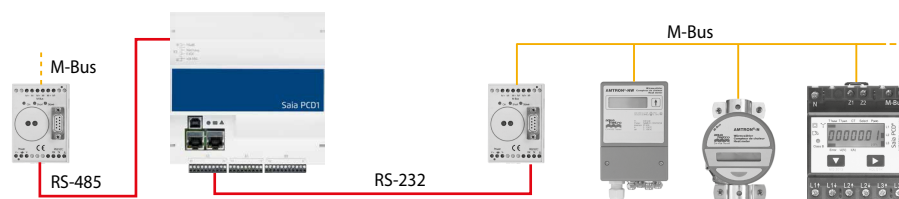

## Memory modules

The onboard memory can be extended by means of a PCD7.Rxxx module in slot M1. In addition, BACnet® IP or LON IP can be enabled.

For more information about memory management and construction, see Chapter 1.1 Saia PCD® System description.

### Memory extension and communication

PCD7.R550M04	Flash memory module with 4 MByte file system (for user program backup, web pages, etc.)	M1
PCD7.R560	Flash memory module for BACnet® firmware	M1
PCD7.R562	Flash memory module for BACnet® firmware with 128 MByte file system	M1
PCD7.R580	Flash memory module for LON IP firmware	M1
PCD7.R582	Flash memory module for LON IP firmware with 128 MByte file system	M1
PCD7.R610*	Base module for Micro SD Flash Card	M1
PCD7.R-MSD1024*	Micro SD Flash Card 1024 MB, PCD formatted	PCD7.R610

\*) In preparation, see section C2 Product status



PCD7.R55xM04

PCD7.R610



For the parallel operation of S-Monitoring and BACnet® respectively LON, please note the instructions on the support homepage [www.sbc-support.com](http://www.sbc-support.com)

## Accessories and consumables

### EPLAN macros

For project planning and engineering EPLAN macros are available



ePLAN® electric P8 macros are available from the support page.

Macros and product data may also be obtained from the ePLAN® data portal.



### Battery for data backup

Type	Description
4 507 4817 0	Lithium battery for PCD processor unit (RENATA button battery type CR 2032)



### Plug-in screw terminal blocks

4 405 5089 0	Plug-in screw terminal block, 11-pole, labeling 0...10	Terminal X0
4 405 5087 0	Plug-in screw terminal block, 9-pole, labeling 11...19	Terminal X1
4 405 5088 0	Plug-in screw terminal block, 10-pole, labeling 20...29	Terminal X2
4 405 4919 0	Plug-in screw terminal block, 10-pole, labeling 30...39	Terminal X3



# 1.5 Saia PCD® PCS1

A PCS1 controller can be freely programmed. The integrated data points and communication interfaces have been coordinated with HeaVAC applications. They are available to the user programs via function blocks (FBoxes).



### System properties

- ▶ 19, 30, 44 data points in the basic device, can be enhanced via field buses
- ▶ Compact dimensions
- ▶ User memory for historic data

### Options

- ▶ Integrated graphic display with single-button operation
- ▶ Integrated manual and coupler level
- ▶ Plug-in spring-loaded terminals with cover
- ▶ LoN FTT10 already onboard (PCS1.C88x)



Compared to the Saia PCD® system, PCS1 is not based on the Saia PCD® COSinus operating system and does not have an Automation Server!

The integral graphical display supports the ASCII character set (Western Europe). In extended character sets (Cyrillic) an external display is recommended (e.g. PCD7.D23x). Please note the instructions in manual 26/795.

### Configuration example

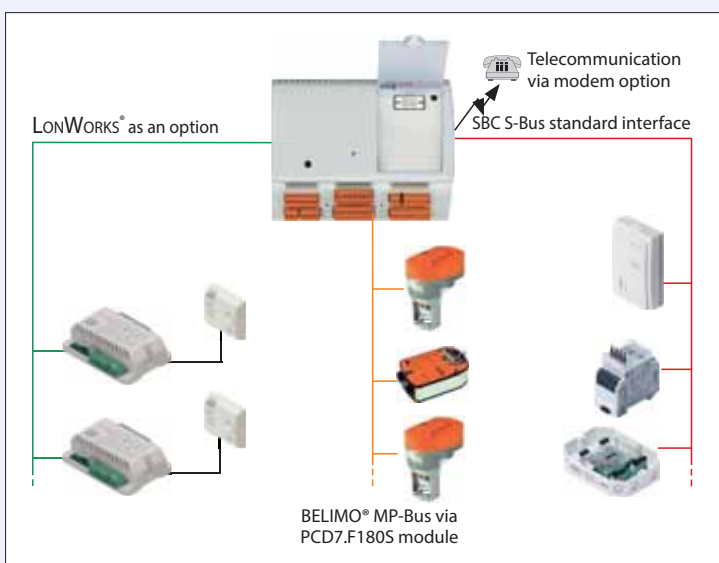

### Communication interfaces

- ▶ 1 x PGU RS-232 (onboard X3)
- ▶ 1 x S-Bus RS-485 M/S (onboard X1)
- ▶ 1 x optional via PCD7.F1xxxS module:
  - ▶ RS-232 for EIB/KNX, M-Bus, etc.
  - ▶ RS-422 local operating terminal
  - ▶ RS-485 S-Bus, etc.
  - ▶ Belimo MP-Bus
- ▶ 1 x LoNWORKS® (onboard with PCS1.C88x)

### Range of use and positioning examples

- ▶ small ventilation systems
- ▶ small heating systems
- ▶ compact air conditioning systems
- ▶ small utility-supplied heating transfer stations

### Example application

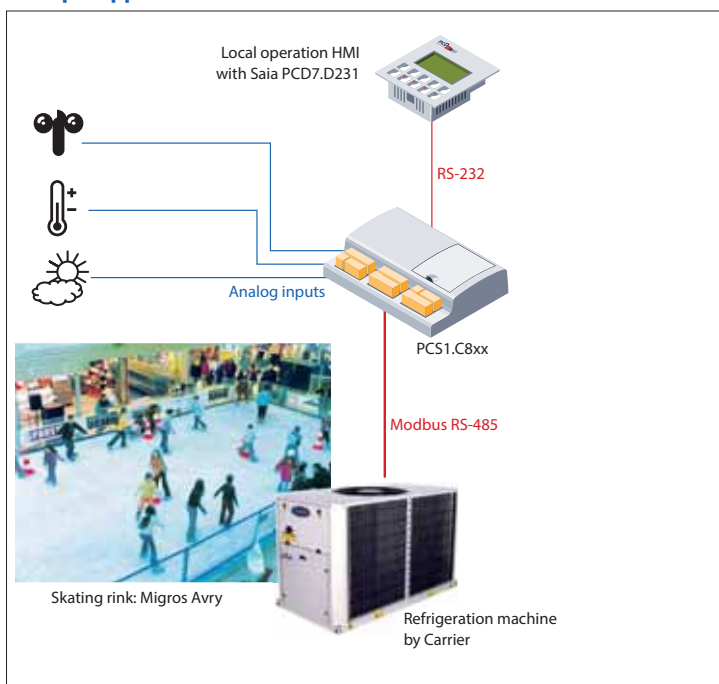

The construction and data point mix make it suitable for use in compact air conditioning devices, for example.

### Mounting

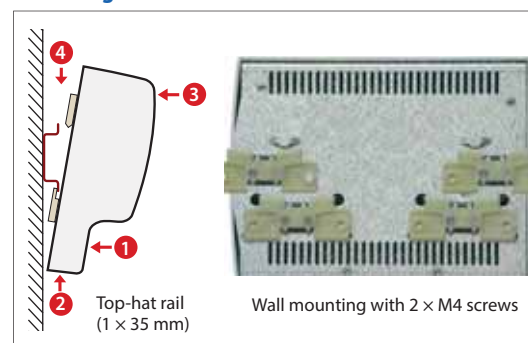

### Dimensions

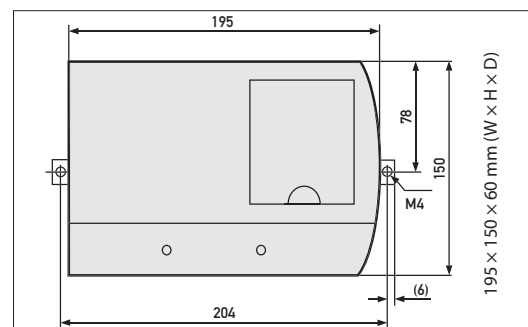

1 Automation stations

2 HMI Visualization and operating

3 Dedicated room controller

4 Consumption data acquisition

5 Cabinet components

## Overview of PCS1



	PCS1.C42x				PCS1.C62x				PCS1.C82x				PCS1.C88x			
	PCS1.C420	PCS1.C421	PCS1.C422	PCS1.C423	PCS1.C620	PCS1.C621	PCS1.C622	PCS1.C623	PCS1.C820	PCS1.C821	PCS1.C822	PCS1.C823	PCS1.C880	PCS1.C881	PCS1.C882	PCS1.C883
Internal graphic display	•	•	-	-	•	•	-	-	•	•	-	-	•	•	-	-
Manual operation	•	-	•	-	•	-	•	-	•	-	•	-	•	-	•	-
Lon FTT10	-	-	-	-	-	-	-	-	-	-	-	-	•	•	•	•
<b>Data points</b>																
Digital input 0.2 ms	0				2				3				3			
Digital input 8 ms	4				4				9				9			
Digital input/output	2				4				4				4			
Relay output make contact	4				4				4				4			
Relay output changeover contact	0				4				4				4			
Universal input (0...10 V; 24 V on/off)	2				2				4				4			
Analog input (Pt/Ni 1000, 0.6° C)	0				0				4				4			
Analog input (Pt/Ni 1000, 0.15° C)	4				6				8				8			
Analog output (0...10 V)	3				4				4				4			
Total	19				30				44				44			

### Technical data

Internal graphic display	•	•	-	-	•	•	-	-	•	•	-	-	•	•	-	-
Manual operation	•	-	•	-	•	-	•	-	•	-	•	-	•	-	•	-
Lon FTT10	-	-	-	-	-	-	-	-	-	-	-	-	•	•	•	•

### Data points

Digital input 0.2 ms	0				2				3				3			
Digital input 8 ms	4				4				9				9			
Digital input/output	2				4				4				4			
Relay output make contact	4				4				4				4			
Relay output changeover contact	0				4				4				4			
Universal input (0...10 V; 24 V on/off)	2				2				4				4			
Analog input (Pt/Ni 1000, 0.6° C)	0				0				4				4			
Analog input (Pt/Ni 1000, 0.15° C)	4				6				8				8			
Analog output (0...10 V)	3				4				4				4			
Total	19				30				44				44			

### General data

Supply voltage	24 VDC -20/+25%, incl. 5% ripple in accordance with EN/IEC 61131-2		
Power consumption	max. 10 W		
Dimensions	195 × 150 × 60 mm (W × H × D)		
User memory	1 MByte flash and 896 kByte RAM		
Data storage	Flash > 10 years / RAM 5 days with super capacitor (user memory, hardware clock)		
Processing time	Bit instruction 5 µs, word instruction 20 µs		
Hardware clock	Time values: s/min/h, week/ day of the week, month/ day of the month, year deviation: < 60 s/month		

### PCS1 Media

Register (32 Bit)	R 0...4095	Timer / Zähler	T/C 0...1599
Flags (1 Bit)	F 0...8191	Text / Datenbausteine	X/DB 0...5999

### Layout

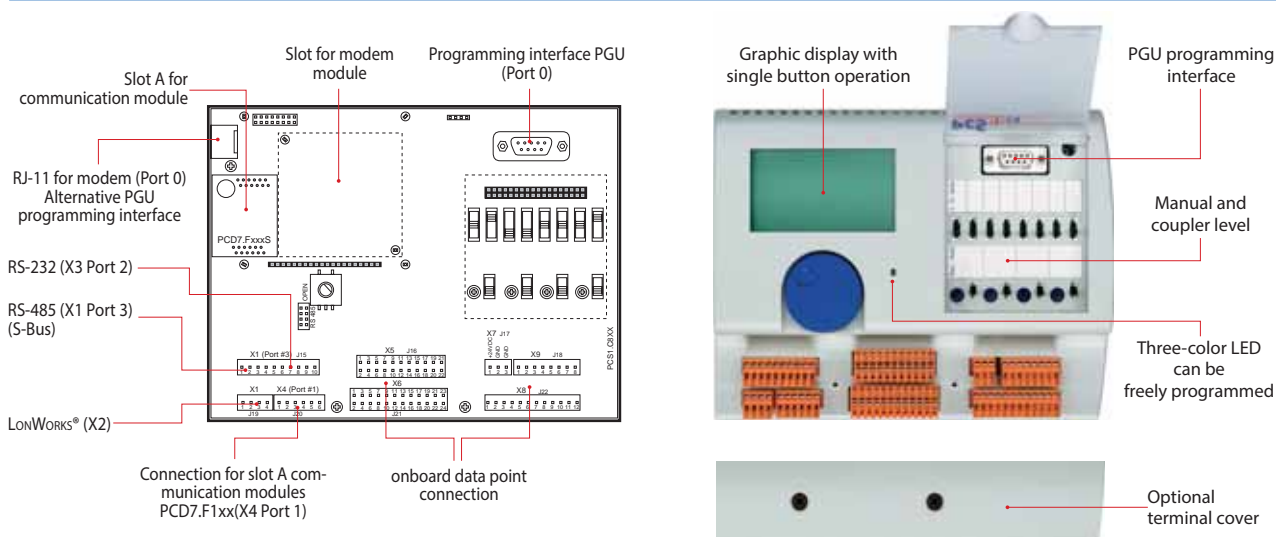

The devices are supplied ready-assembled under the following order codes:

Data points	Base unit	PCD7.F1xxS	Modem	Software	Mechanical options
19	PCS1.C42x	0 = none	0 = none	0 = PG5	0 = no terminal cover
30	PCS1.C62x	A = ..F110S	1 = analog		1 = with terminal cover
44	PCS1.C8xx	B = ..F121S	2 = ISDN		2 = no terminal cover, wall mounting
		D = ..F150S	3 = GSM		3 = with terminal cover, wall mounting
		E = ..F180S			

**Example PCS1.C820 A200**

Base unit with graphic display and manual control, additional RS-422/RS-485 interface, ISDN modem, can be freely programmed with PG5, without terminal cover.

**Base units with 19 data points**

PCS1.C420	with graphic display and manual operation
PCS1.C421	with graphic display
PCS1.C422	with manual operation
PCS1.C423	no display, no manual operation

**Base units with 30 data points**

PCS1.C620	with graphic display and manual operation
PCS1.C621	with graphic display
PCS1.C622	with manual operation
PCS1.C623	no display, no manual operation

**Base units with 44 data points**

PCS1.C820	with graphic display and manual operation
PCS1.C821	with graphic display
PCS1.C822	with manual operation
PCS1.C823	no display, no manual operation

**Low base units with 44 data points**

PCS1.C880	with graphic display and manual operation
PCS1.C881	with graphic display
PCS1.C882	with manual operation
PCS1.C883	no display, no manual operation

**Accessories and consumables**

440549410	Complete 8-part spring terminal set
411149270	Terminal cover incl. 2 screws
410948490	Set for wall mounting
431086810	Adhesive labels for PCS1 with manual operation
PCD8.K111	Programming cable for configuration/programming tools

Orders must quote the full details.

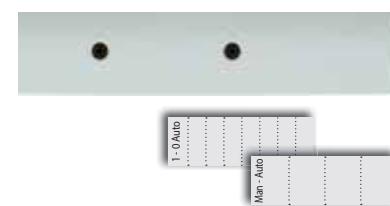
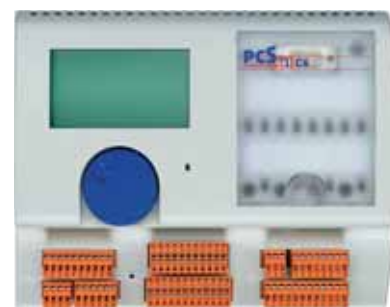

1 Automation stations

2 HMI Visualization and operating

3 Dedicated room controller

4 Consumption data acquisition

5 Cabinet components





## 1.6 Local data points

### 1.6.1 Saia PCD3.T66x Smart RIO

page 70

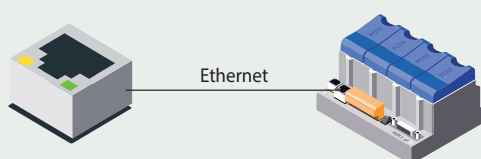

Modular, programmable **Smart Ethernet RIO** with PCD3 I/O-modules for DIN top-hat rail mounting

Used for:

- ▶ Fast local I/O capture, regulation and management
- ▶ Cycle times < 1 s

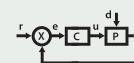

### 1.6.2 Saia PCD3.T760 Profibus RIO

page 73

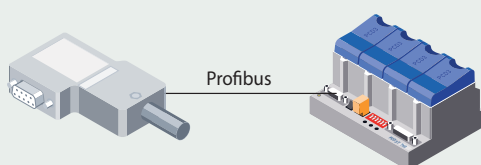

Robust, modular **Profibus-DP RIO** with PCD3 I/O-modules for DIN top-hat rail mounting

Used for:

- ▶ Fast local I/O capture and regulation
- ▶ Cycle times < 1 s

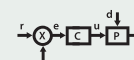

### 1.6.3 Saia PCD7.Lxx S-Bus RIO

page 74

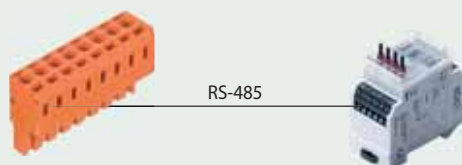

**S-Bus (RS-485) RIO modules**

with manual control level for installation in switch cabinet

Used for:

- ▶ Simple local I/O capture
- ▶ Cycle times > 1 s



## 1.6.1 Saia PCD3.T66x remote I/O-stations

The Smart RIOs are more than just another Ethernet remote I/O-system. They can be programmed like a PLC and are therefore the ideal solution for distributed automation in line with the lean philosophy. Smart RIOs can be equipped with PCD3 I/O-modules and extended to max. 256 I/Os per RIO station using PCD3 I/O-module holders.



### Layout for Saia PCD3.T66x: Smart RIO head station with 4 slots for I/O-modules

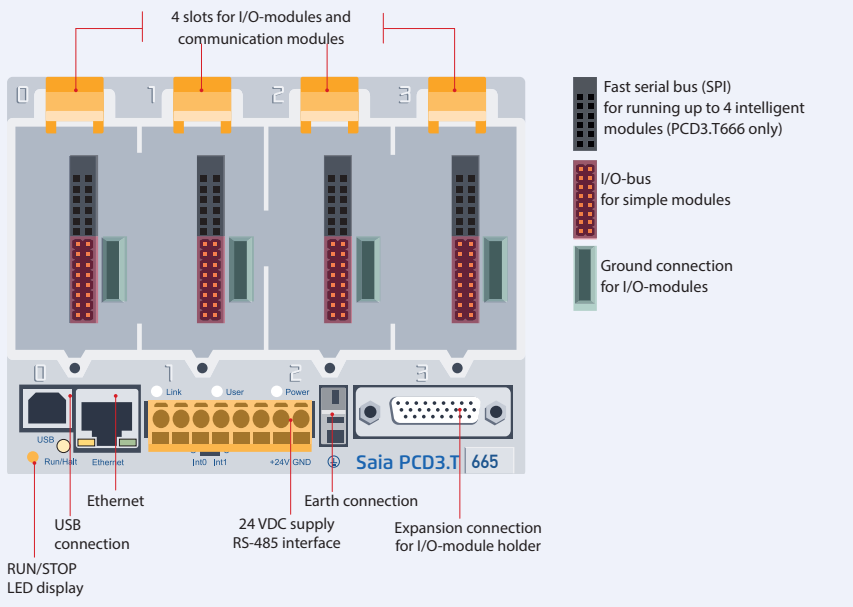

### Dimensions

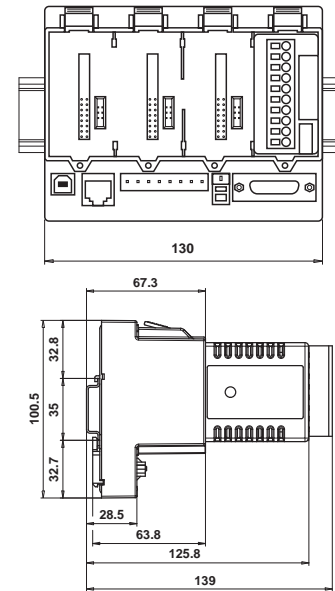

### System properties

- ▶ Can be used as a simple local I/O-station or an intelligent programmable I/O-station.
- ▶ Can be programmed with PG5. Important or time-critical tasks can be processed directly in the RIO.
- ▶ The RIOs' user programs are managed centrally in the Smart RIO Manager (PCD) and distributed to the RIOs automatically.
- ▶ Data exchange with efficient Ether-S-IO protocol. Simple configuration with the RIO network configurator.
- ▶ Cross-communication with other PCD systems using Ether-S-Bus (FBoxes).
- ▶ Intelligent communication modules (M-Bus, DALI) are supported with PCD3.T666.
- ▶ Other communication protocols (e.g. Modbus) via Ethernet TCP/IP and, with PCD3.T666, via the on-board RS-485 interface as well.
- ▶ Integrated Automation Server

### I/O-modules

The standard I/O-modules of the PCD3 series can be used. For more information and types, see section "PCD3 input/output modules".



### I/O-expansions to max. 256 I/Os per RIO station

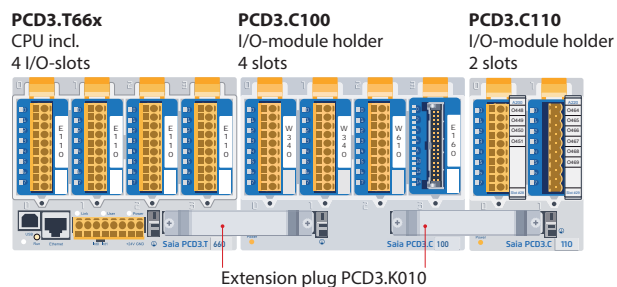

### Ordering information

#### Smart RIO

PCD3.T665	Smart-RIO, Ether-S-IO data exchange, programmable, 32 kByte program memory
PCD3.T666	Smart-RIO, Ether-S-IO data exchange, programmable, 128 kByte program memory, serial interfaces

#### I/O-module holder

PCD3.C100	Expansion module holder with 4 I/O-slots
PCD3.C110	Expansion module holder with 2 I/O-slots
PCD3.C200	Expansion module holder with 4 I/O-slots and terminals for 24 VDC power supply

## Distributed automation system design with Smart RIO

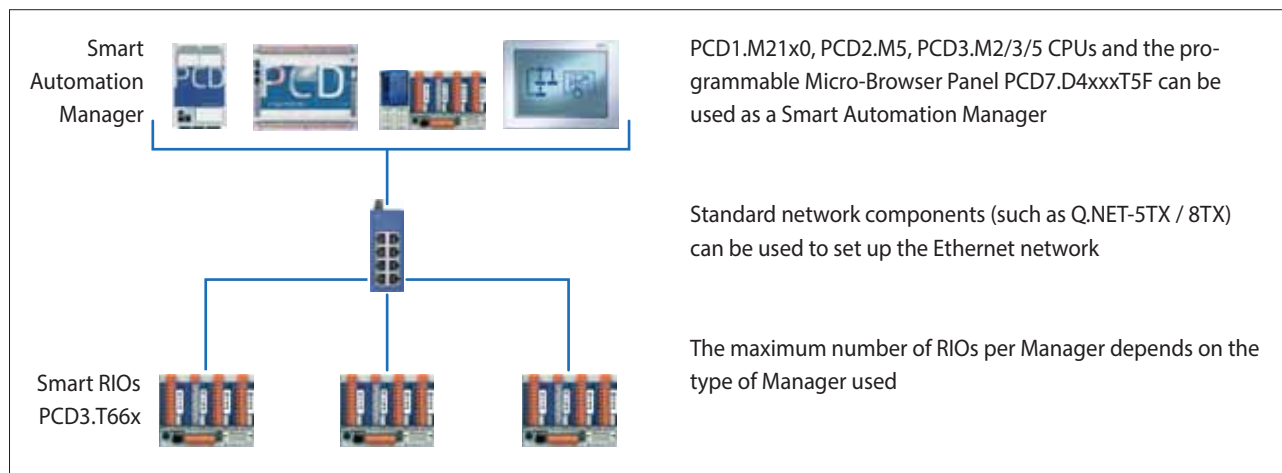

The Smart RIOs can be used both as simple local I/O-stations and as intelligent programmable RIO stations.

## Central program management in the Manager

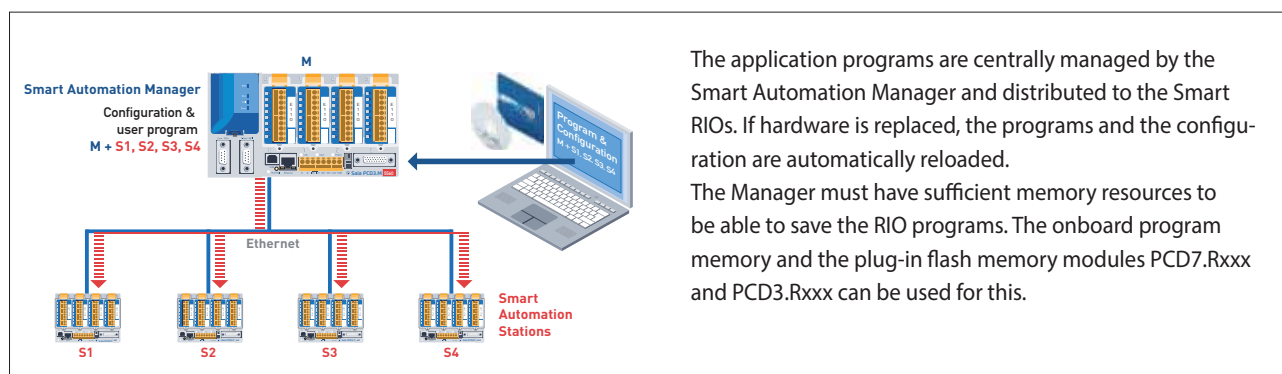

## Data transfer with Ether-S-IO protocol

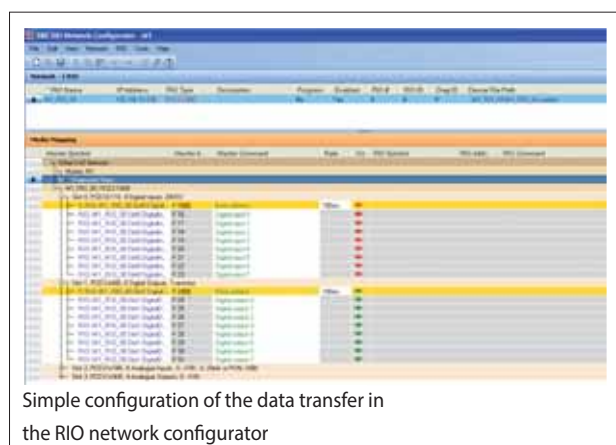

The exchange of data can be easily configured in PG5 with the RIO network configurator. The configured exchange of data between RIO and the Manager is processed automatically by the operating system. No user program is required for this. The Manager sends the data to the Smart RIOs on a cyclical basis with broadcast or unicast telegrams. The RIOs also send their data or the statuses of their inputs to the RIO Manager on a cyclical basis.

## Data transfer cycle times

Number of RIOs	Minimum cycle time Data transfer
10	50 ms
20	100 ms
40	200 ms
80	400 ms
128	800 ms

**2 different transfer cycle times can be set for each RIO station:**

- a short cycle time for high-priority data
- normal cycle time for low-priority or slow data

## Technical data

Property	PCD3.T665	PCD3.T666
Number of inputs/outputs	64 in base unit, extensible to 256	
I/O-module slots	4 in base unit, extensible to 16	
I/O-modules supported	PCD3.Exxx, PCD3.Axxx, PCD3.Bxxx, PCD3.Wxxx	
Max. number of RIO stations	128	
Protocol for data transfer	Ether-S-IO	
Ethernet connection	10/100 Mbit/s, full-duplex, auto-sensing, auto-crossing	
Default IP configuration	IP address: 192.168.10.100 Subnet mask: 255.255.255.0 Default gateway: 0.0.0.0	
USB port for configuration and diagnostics	yes	
Program memory	32 kByte	128 kByte
Web server for configuration and diagnostics	yes	
Web server for user pages	yes	
Onboard file system for web pages and data	512 kByte	
BACnet® or LONWORKS®	no	no
Onboard interrupt inputs	2	
Onboard RS-485 interface	no	yes
Special modules	for I/O-slot 0 only	PCD3.F1xx
	for I/O-slots 0...3 (up to 4 modules)	PCD3.H1xx --- --- PCD3.H1xx counter PCD3.F26x DALI PCD3.F27x M-Bus
S-Web alarming/trending	no	no
Watchdog	no	
Real-time clock	no	
Software clock (not battery-powered)	yes, synchronized by the Manager	
Battery	no	

## Smart Automation Manager (master station)

Max. 16 RIO stations	PCD3.M2130, PCD3.M2330
Max. 32 RIO stations	PCD1.M212x, PCD3.M3330,
Max. 64 RIO stations	PCD1.M2160, PCD3.M5340, PCD3.M5540, PCD3.M6x40, PCD7.D457VT5F, PCD7.D410VT5F, PCD7.D412DT5F
Max. 128 RIO stations	PCD3.M5560, PCD3.M6560, PCD3.M6860

## General data

Supply voltage	24 VDC ±20 % smoothed or 19 VAC ±15 % full-wave rectified
Capacity of 5 V bus / 24 V bus	max. 650 mA/100 mA
Ambient temperature	0...+55 °C or 0...+40 °C (depending on mounting position)
Storage temperature	-20...+70 °C
Relative humidity	30...95 % RH with no condensation
Mechanical strength	according to EN/IEC 61131-2

## System properties/limits and recommendations for lean automation

With lean automation, it is not recommended to make full use of the specified limits with regard to the maximum number of stations per Manager and the maximum number of I/Os per RIO. The following points should be taken into account:



- ▶ The load on the RIO Manager increases with the rising number of RIO stations. This has an impact on the overall application in the RIO Manager.
- ▶ If there is a large number of RIOs, a sufficiently large amount of PCD media must be reserved on the Manager for the data transfer.
- ▶ With a rising number of RIO stations, the build and download process in PG5 is lengthened accordingly. Likewise, the start-up behavior of the Manager or the entire RIO network is proportionately longer.

**Recommendations:** 20 Smart RIOs per Manager is a sensible configuration for efficient and problem-free operation, and simple commissioning and support.

The Smart RIOs do not have a battery. In the event of an interruption to the power supply, all the data in the RAM memory (registers, flags, DBs/text) will be lost. Data and parameters that are to remain must either be transferred by the Manager or stored in the RIO's flash file system. If this is not possible, the use of a normal controller in place of a Smart RIO is recommended. The user programs are stored in the flash memory of the RIOs and are retained in the event of an interruption to the power supply.

## 1.6.2 Saia PCD3.T760 Profibus-RIO

The PCD3.T760 head station serves as a local peripheral node. These compact PCD3 RIOs snap onto a 35 mm DIN rail and can be equipped with PCD3 I/O-modules. Up to 3 PCD3.Cxxx module holders can be connected to the PCD3.T760. This means that the user can connect a maximum of 16 I/O-modules or 256 inputs/outputs per RIO node.

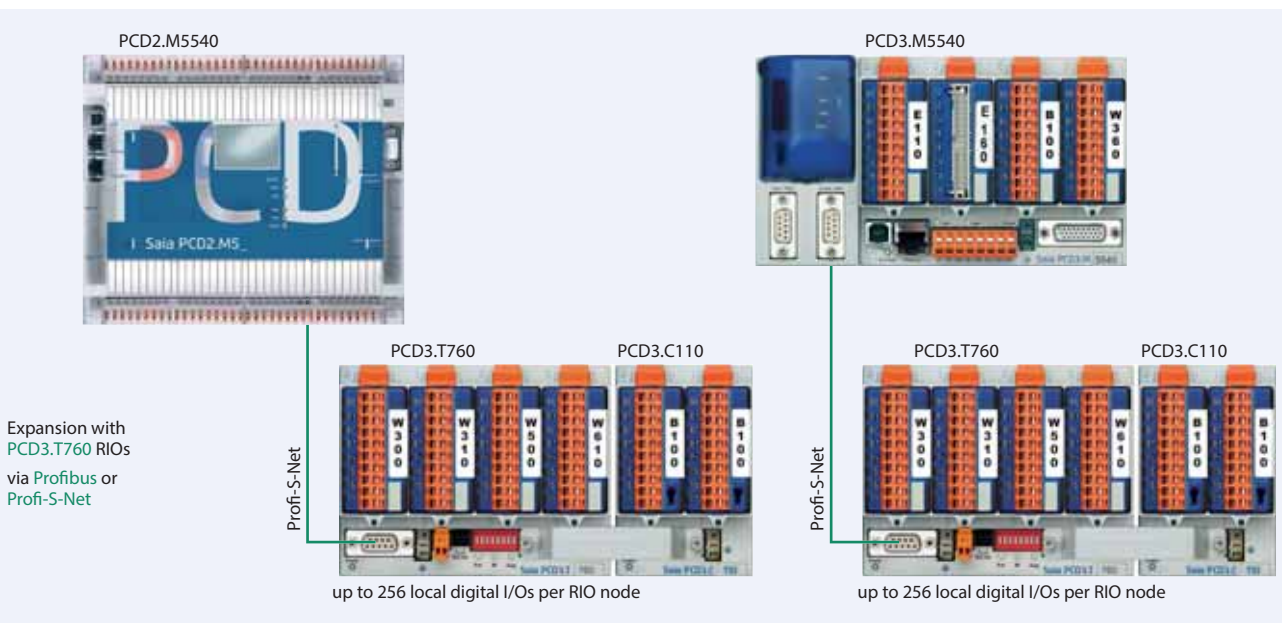

Dimensions: Identical to PCD3.T66x, see 1.6.1 Saia PCD3.T66x remote I/O-stations

### Web server for commissioning, diagnostics and service

The integral web server in the PCD3.T760 offers users the greatest advantages during commissioning, diagnostics and service. Access is via a widely known, easy-to-operate standard web browser. Using RS-232 or Profi-S-Net, the user has access not only to the predefined equipment and specific system HTML pages, but also to all information data in the RIOs. This makes it easy to check the states of all I/O-signals (digital/analog/counters), and specifically modify these input/output states with a mouse click.

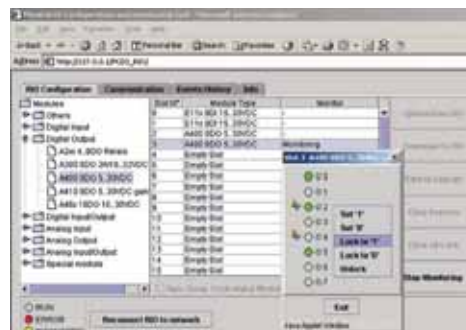

Technical data	PCD3.T760
Number of inputs/outputs or I/O-module slots	256 <sup>1)</sup> 16 <sup>2)</sup>
Expansion connection	yes
Profibus-DP < 1.5 Mbs/s	DPV0
User web server memory	128 kByte flash
Number of RIO stations	max. 128 per master station

### General

Supply voltage	24 VDC $\pm 20\%$ smoothed or 19 VAC $\pm 15\%$ full-wave rectified
Capacity 5 V/24 V bus	max. 650 mA/100 mA

<sup>1)</sup> When using digital I/O-modules with 16 I/Os each.

<sup>2)</sup> With PCD3.Cxxx module holders.

### Ordering information for PCD3.T76x accessories

Type	Description
PCD3.K225	Accessories for the configuration of the PCD3 RIOs Interface cable PCD3.T760 web server to PC (2.5 m); RIO configuration cable

### 1.6.3 S-Bus RIO modules

The RAIL-module is extremely expandable. Bridge plugs quickly and easily connect bus and supply voltage between the modules. Their compact construction allows small units to be built up on site to form an optimum system. Thus these devices save much work and space while being more useful and efficient. These small field bus modules are very well suited for being built into switch cabinets, sub-distributors and surface-mounted housings.



RAIL module



SAFE module

#### System properties

- ▶ S-Bus connection via simple two-wire line
- ▶ Automatic recognition of operating mode/ baud rate
- ▶ RAIL modules: Switch cabinet model for mounting on 35 mm DIN top-hat rail
- ▶ SAFE modules: Protected model for surface mounting with protection class IP 65
- ▶ With manual control level and feedback via the bus
- ▶ State indication by means of LED
- ▶ Simple setting of the S-Bus address by means of a rotary switch

#### Dimensions

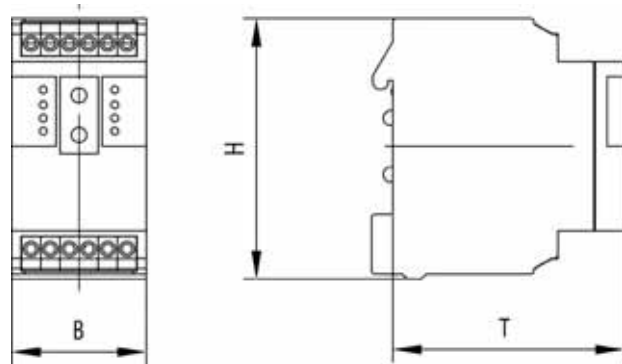

#### Serial S-Net RAIL (top-hat rail mounting)

Type	Description	W × H × D [mm]
PCD7.L100	Input module with 4 digital inputs 24 VDC/VAC, with local override	35 × 70 × 74
PCD7.L110	Input module with 4 digital inputs 24 VDC/VAC, without local override	35 × 70 × 74
PCD7.L120	Input/output module with 2 relays 250 VAC and 4 digital inputs 24 VDC/VAC, with local override and integrated functionality for lighting and shading	50 × 68 × 60
PCD7.L130	Input module with 10 digital inputs 24 VDC/VAC	35 × 70 × 74
PCD7.L200	Output module with 4 relays 250 VAC, 6 A, with local override	35 × 68 × 60
PCD7.L210	Output module with 4 triacs 24...250 VAC, 0.8 A, with local override	35 × 68 × 60
PCD7.L300	Analog module with 4 inputs each of Pt 1000 and 0...10 VDC	35 × 70 × 74
PCD7.L310	Analog module with 4 inputs each of Ni 1000 and 0...10 VDC	35 × 70 × 74
PCD7.L320*	Analog input module with 8 universally configurable inputs	35 × 70 × 74
PCD7.L410	Analog module with 4 outputs 0...10 VDC, with local override	35 × 70 × 69

\* In preparation, see section C2 Product status

Serial S-Net RAIL  
(top-hat rail mounting)

#### Serial S-Net SAFE (surface mounted)

Type	Description	W × H × D [mm]
PCD7.L121	Input/output module with 2 relays 250 VAC and 4 digital inputs 24 VDC/VAC. Range of uses: light and shade applications.	159 × 41.5 × 120

Serial S-Net SAFE  
(surface mounted)

#### Power pack 230 VAC/24 VDC

Type	Description	W × H × D [mm]
PCD7.L500	For supply of all RAIL and SAFE modules, 240 VAC   24 VDC/700 mA, max. 15 modules	50 × 70 × 65

Power pack  
230 VAC/24 VDC

#### Bus termination

Type	Description	W × H × D [mm]
PCD7.T161	Termination box RS-485 (line termination resistor), electrically isolated, 230 VAC	17.5 × 89.2 × 63.4
PCD7.T162	Termination box RS-485 (line termination resistor), electrically isolated, 24 VAC/DC	17.5 × 89.2 × 63.4



Bus termination



Example system design

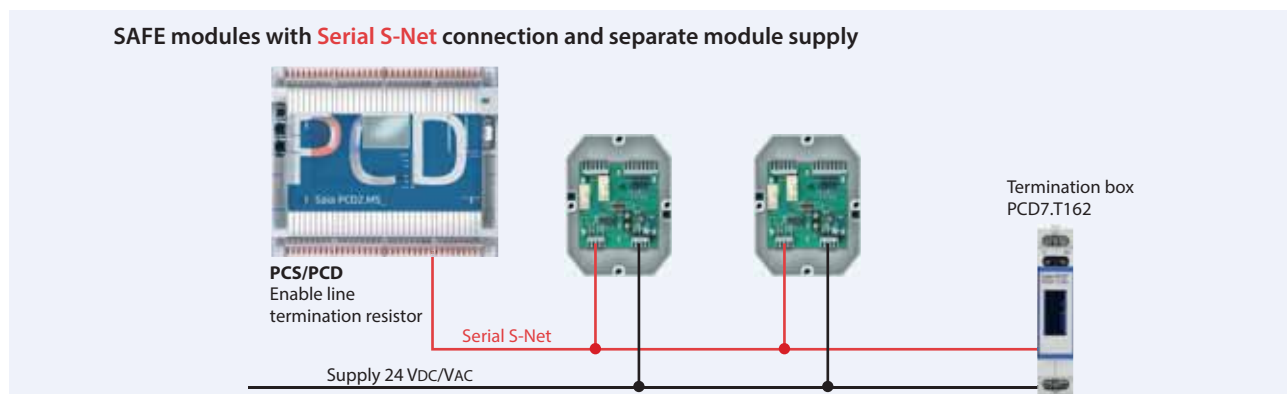
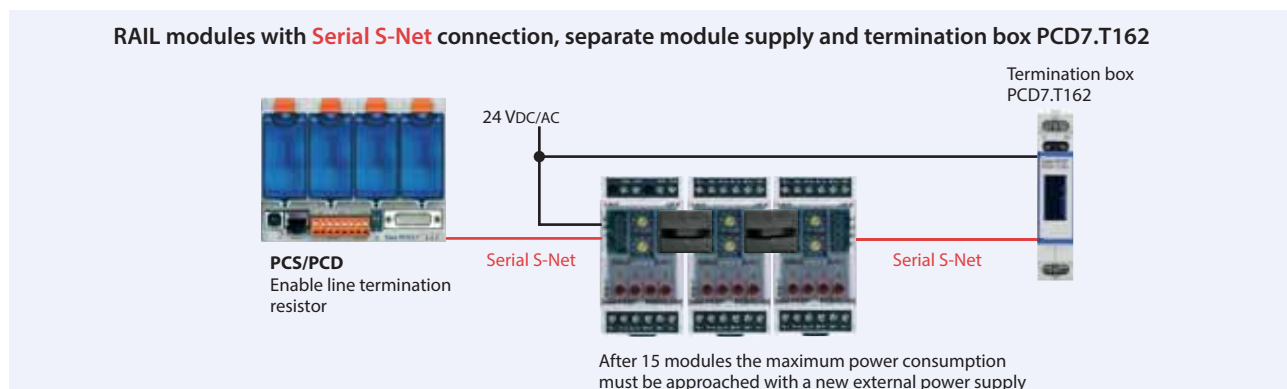
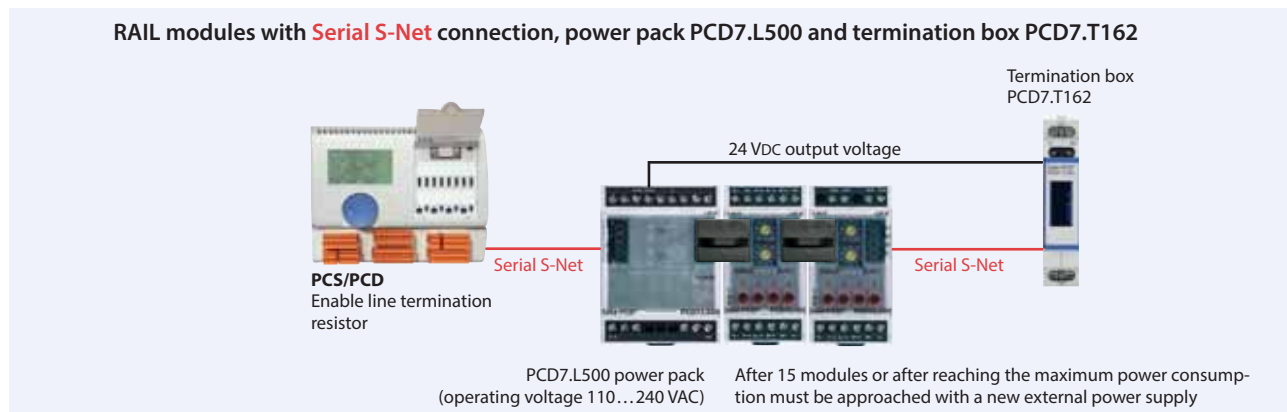

The RAIL modules can also be mounted in series in an IP 66 housing for local field assembly. Further information can be obtained from the manufacturer Spelsberg, for example.

**Use of slaves in Serial S-Net**

Slaves can be RIOs (remote input/output modules), external devices (e.g. electronic power meters) or PCD stations. When doing this, attention must be paid to the electric load of the Serial S-Net. RAIL and SAFE local input/output modules have a high impedance and load the Serial S-Net only slightly. Therefore, up to 100 of these slaves can be used in one segment.



**If the bus cycle time is critical, fewer than 30 slaves should be operated in one segment.**

Limitation of electrical load on the Serial S-Net:

Total PCD systems (incl. master PCD) and RIOs on one Serial S-Net branch

No. of PCDs	No. of RIOs	No. of PCDs	No. of RIOs	No. of PCDs	No. of RIOs	No. of PCDs	No. of RIOs
0...7	100	14	72	21	44	28	16
8	96	15	68	22	40	29	12
9	92	16	64	23	36	30	8
10	88	17	60	24	32	31	4
11	84	18	56	25	28	32	0
12	80	19	52	26	24		
13	76	20	48	27	20		

1 Automation stations

2 HMI Visualization and operating

3 Dedicated room controller

4 Consumption data acquisition

5 Cabinet components



## 1.7 Accessories for Saia PCD® programmable controllers

### 1.7.1 I/O-module integration into switching cabinet

The way to achieve convenient and fast integration of the I/O-modules into the switching cabinet is to use the adapters by SBC. I/O-modules with ribbon connections, in particular, can be installed quickly and easily in the switching cabinet. The modules with terminals can also be connected to the adapters using traditional stranded wires. The adapters either are available for galvanic separation of the outputs with relays or as simple I/O-adapters with voltage distribution.

#### System characteristics

- ▶ Available as I/O-terminal adapter or relay interface
- ▶ Relay interface with manual mode
- ▶ Compatible with Saia PCD2 and PCD3 systems
- ▶ For connection with system cable or stranded wire
- ▶ For DIN rail mounting



#### Pluggable ribbon cables with connector at the Saia PCD® end

Cable for the digital modules with 16 inputs/outputs

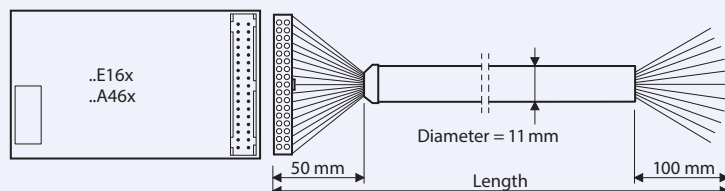

#### PCD2.K221/K223 cable

Sheathed, round cable with 32 strands of 0.25 mm<sup>2</sup> (AWG 24), 34-pole ribbon connector at the PCD end  
Free, unshielded 100 m ends at the process end  
Stranded wires, color-coded  
Cable length PCD2.K221 = 1.5 m  
PCD2.K223 = 3.0 m

Terminal adapter for digital inputs/outputs

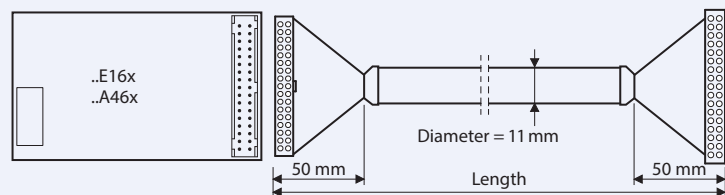

#### PCD2.K231/K232 cable

Sheathed, round ribbon cable with 34 strands of 0.09 mm<sup>2</sup>, 34-pole ribbon connector at both ends  
Cable length PCD2.K231 = 1.0 m  
PCD2.K232 = 2.0 m

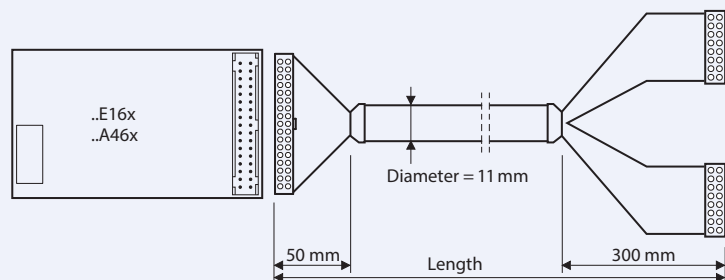

#### PCD2.K241/K242 cable

Sheathed, round ribbon cable with 34 strands of 0.09 mm<sup>2</sup>, 34-pole ribbon connector at the PCD end  
Process end divided into 2 branches, each 300 mm in length, leading to 16-pole ribbon connectors  
Cable length PCD2.K241 = 1.0 m  
PCD2.K242 = 2.0 m

## 1.7.1 I/O-module integration into switching cabinet

To facilitate and speed up the installation of controllers, various adapters are offered which can be directly connected with the Saia PCD® I/O-modules via system cables. Apart from terminal adapters, there are also relay interfaces available which enable simple galvanic separation. The relay interfaces can be connected with ribbon cables or with stranded wires.



### Terminator adapter for I/O-modules with ribbon connection

#### Mechanical layout

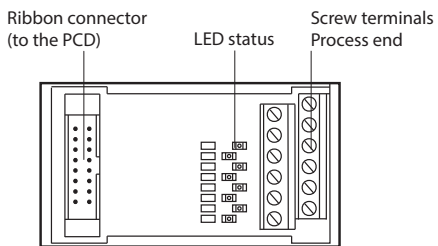

For DIN rail mounting

#### Terminal adapter for 8 inputs/outputs

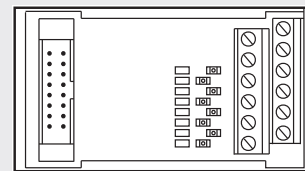

**Terminal adapter PCD2.K51x**  
16-pole ribbon connector at the PCD end Process end 2x6  
Screw terminals 0.5...1.5 mm<sup>2</sup>  
PCD2.K510 without LEDs  
PCD2.K511 with LEDs  
(source operation)

Dimensions: 42 × 82 × 60 mm (B × H × T)

#### Terminal adapter for 16 inputs/outputs

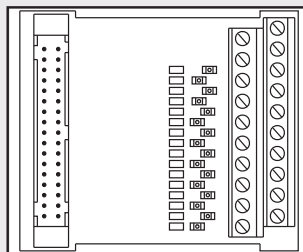

**Source adapter PCD2.K520/K521**  
34-pole ribbon connector at the PCD end Process end 2x10  
screw terminals 0.5...1.5 mm<sup>2</sup>  
PCD2.K520 without LEDs  
PCD2.K521 with LEDs  
(source operation)

Dimensions: 65 × 82 × 60 mm (B × H × T)

#### Terminal adapter for 16 inputs/outputs

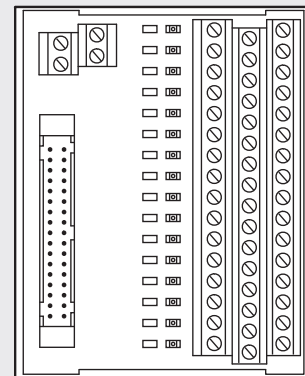

**Terminal adapter PCD2.K525**  
34-pole ribbon connector at the PCD end Process end 3x16  
screw terminals 0.5...1.5 mm<sup>2</sup>  
with LEDs (source operation)

Dimensions: 94 × 82 × 72 mm (B × H × T)

#### Adapter relay interface

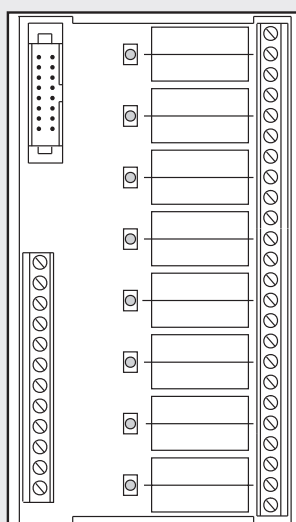

**Relay interface PCD2.K551** for 8 PCD transistor outputs with 24 screw terminals and LED  
Switching capacity of the changeover contacts 10 A/250 VAC or 10 A/24 VDC (ohmic), 24 VDC spool 16-pole ribbon connector or screw terminals at the PCD end 24 screw terminals 0.5...1.5 mm<sup>2</sup> at the process end  
**Mechanical data**  
Diameter of the screw terminals: M2.6 mm  
Starting torque: 0.4 Nm

Dimensions: 128 × 82 × 55 mm (B × H × T)

#### Adapter relay interface

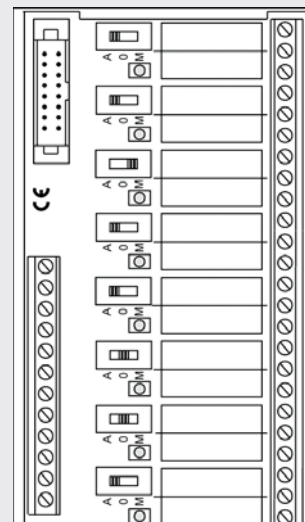

**Relay interface PCD2.K552** for 8 PCD transistor outputs with 24 screw terminals, LED and manual operation mode (switch on-off-auto) and 1 output as feedback for the manual mode  
Switching capacity of the changeover contacts 10 A/250 VAC or 10 A/24 VDC (ohmic), 24 VDC spool 16-pole ribbon connector or screw terminals at the PCD end 24 screw terminals 0.5...1.5 mm<sup>2</sup> at the process end  
**Mechanical data**  
Diameter of the screw terminals: M2.6 mm Starting torque: 0.4 Nm

Dimensions: 128 × 82 × 44 mm (B × H × T)

## 1.7.2 External modems for top-hat rail installation

With state-of-the-art telecommunications combined with the Saia PCD®, customers can not only save costs in commissioning and maintenance, but also increase the security, availability and profitability of a system. To achieve this, external modems which enable wired as well as wireless communication are available alongside the Ethernet connections of the controllers.



Q.G736-AS2

### System properties

- ▶ Remote support upon commissioning
- ▶ Event or time-driven information and requests to operations and support staff
- ▶ Fault clearance with remote diagnostics
- ▶ Process optimization with software updates and/or updates to process parameters
- ▶ Efficient preventive maintenance by qualified specialists, giving lower repair costs
- ▶ Remote user support for operations directly on the screen

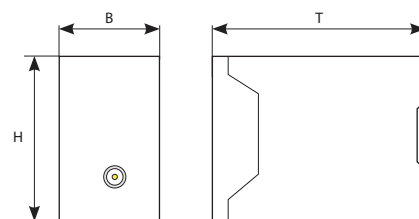

Dimensions: 45 × 76 × 120 mm (B × H × T)

### Telecommunications setup

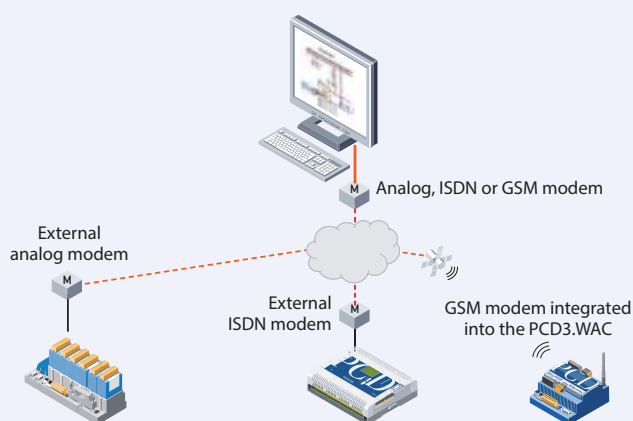

### Accessories



Technical data	GSM modem Q.G736-AS2	Analog modem Q.M716-KS1	ISDN modem Q.T726-RS1
Interface speed	1,200, 2,400, 4,800, 9,600, 19,200, 38,400, 57,600 and 115,200 bps, autobauding		
Interface	V24 (RS-232), D-Sub 9 poles		
Instruction set	Extended AT instruction set		
Frequency band	Dual band GSM 900 and GSM 1800	---	
SIM interface	SIM card: 3V, drawer	---	
Transmission standards	2,400 (V.22bis / V.110), 4,800 (V.32 / V.110), 9,600 (V.32 / V.110), 14,400 (V.34 / V.110) bps	ITU standards: V.21, V.22, V.22bis, V.23, V.32, V.32bis, V.34, Bell 103, Bell 212A	ITU standards: X.75, V.110, V.120
Dialing procedure	---	DTMF (multi-frequency)	---
Telephone line	---	RJ-11 and screw terminals for La + Lb	RJ-45 (ISDN 4-wire)
Antenna connector	FME-m	---	
Voltage supply	---	24 VDC +15%, -30%	---

## 1.7.4 Saia PCD4.U100 upgrade kit

The Saia PCD4.U100 module makes it possible to connect existing Saia PCD4 I/O-modules to the latest Saia PCD3 and PCD2.M5 systems. By upgrading to the latest Saia PCD® system, you can increase the availability and reliability of the system. It is also possible to enhance systems with Automation Server functions and thus prepare them for the future. Installation is easy: Replace Saia PCD4 CPU with PCD4.U100, install Saia PCD3 or PCD2 CPU, connect new or existing PCD4 I/Os and you're done.

Regardless of whether IL or FULPA programming is used, the user programs can be directly transferred to new CPUs with small program adjustments in PG5, i.e., minimum programming effort.



### System overview

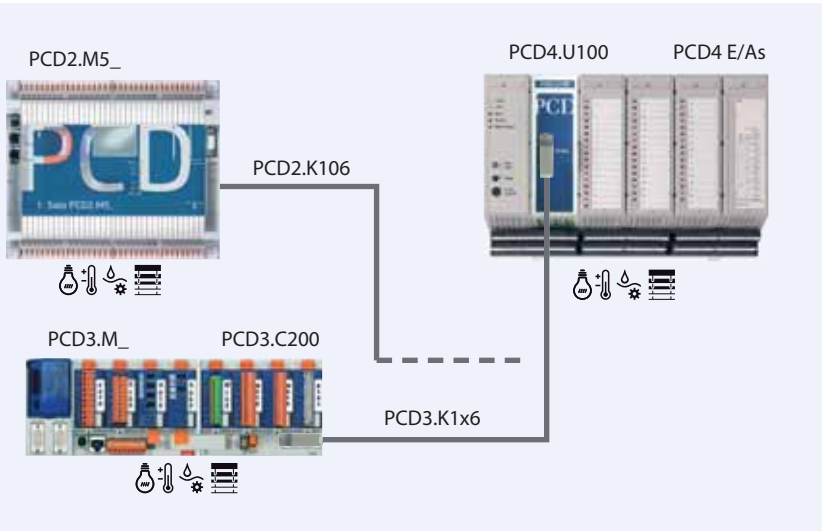

### System properties

- ▶ Supports Saia PCD3.Mxxx0 and Saia PCD2.M5xx0
- ▶ Program can be easily transferred
- ▶ Existing I/Os can still be used

### Features

- ▶ Increase system availability with a minimum of effort: Replace old PCD4 CPUs that are no longer available with the latest Saia PCD® CPUs. The reliability and availability of an existing system or controller can be increased in a time-saving manner and cost-efficiently by using a new CPU.
- ▶ Benefits of the Automation Server functions: New Web/IT functions can also be made available in existing systems with PCD4 systems. Existing program structures can be copied across with small program adjustments and can still be used. Add new PCD2/3 I/O-modules to PCD4 systems. Up to 8 additional PCD2/3 I/O-modules can be integrated into existing systems by replacing the CPUs.
- ▶ Retaining the wiring: The system can be upgraded without costly rewiring of the I/Os.
- ▶ Short upgrade period: The CPU is replaced quickly and the system will be available again in a very short period of time. This way the wiring effort can be delayed to a later point in time.

### Technical overview

Supported PCD types	PCD3.Mxxx0 All PCDs with I/O-bus connection PCD2.M5xx0 (no extension PCD2.C1000/C2000)
Supported PCD4 I/O-modules	All PCD4 I/O-modules except PCD4.Hx are supported
Number of PCD4 I/O-modules	See technical documentation of the PCD4 systems
Max. number of PCD2/3 I/O-modules	8 (only PCD2.C200 module carriers can be used in combination with the PCD3.M system)

### Order details

Type	Description
PCD4.U100	PCD4 upgrade kit basic module (without I/O-bus cable)
PCD3.K106	I/O-bus extension cable for Saia PCD3
PCD2.K106	I/O-bus extension cable for Saia PCD2



## 1.7.4 Saia PCD4.U100 upgrade kit

Once it has been clarified whether all I/O-modules are suitable for upgrading, installation is really easy: Replace Saia PCD4 CPU with PCD4.U100, install Saia PCD3 or PCD2 CPU, connect new or existing PCD4 I/Os.

### 1. Insert PCD4.U100 module

The existing PCD4 CPU is completely removed. To continue to ensure I/O-bus supply, the PCD4 supply module will still be used. The new PCD4.U100 module is used instead of the PCD4 CPU.

The existing power supply module PCD4.N2x0 must have at least the hardware version "B".

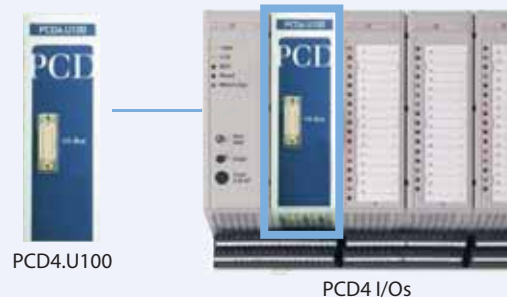

### 2. Connect PCD2.M5\_ or PCD3.M\_

The new PCD CPU is connected to the PCD4.U100 module with the I/O-bus cable.

For PCD2.M5xxx: PCD2.K106.

For PCD3.Mxxxx: PCD3.K116 or PCD3.K106.

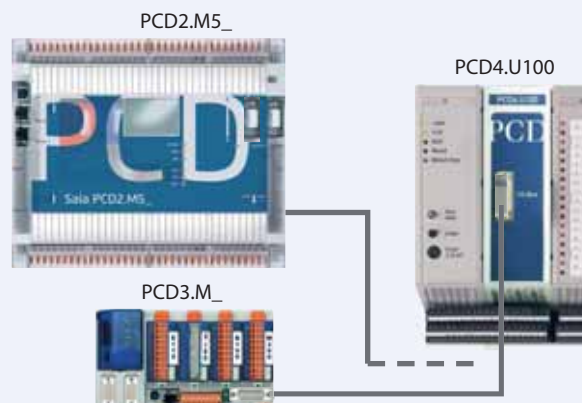

### 3. SERIAL INTERFACES

None of the PCD4 serial interfaces are supported. They must all be replaced with new PCD2/3 interfaces. Maximum of 3 integrated serial interfaces on the PCD3. Maximum of 4 integrated serial interfaces on the PCD2. Additional upgrade option with PCD3.F1xx or PCD3.F2xx/PCD2.F2xxx\*.



### 4. Programming with PG5

Transfer user program to PG5, adjust programs, download and you're done. Detailed descriptions of the individual steps are listed in the PCD4.U100 manual.

\* Additional serial interfaces can be implemented via SPI I/O-slots. However, the I/O-address range will shift as a result. See the manual 26/888 for further details.



## A2

## HMI Visualization and operating

Saia PCD® Web Panel MB are the core and main part of the HMI offering.

From simple semi-graphic panels with a classic keypad to powerful open 15" Windows® eXP touch panels.



1 Automation stations

2 HMI Visualization and operating

3 Dedicated room controller

4 Consumption data acquisition

5 Cabinet components

### 2.1 Overview of types, sizes and resources

Page 84

5.0" to 12" device series with SBC Micro Browser and Saia PCD® Automation Server on board. Firmware and hardware "Made in Switzerland" – Saia Burgess Controls Murten.



### 2.2 Saia PCD® Web Panel MB | Web technology

Page 85

Trending, alarming and system images for the operator. Specific websites for maintenance and service. Local data storage in Excel-compatible CSV format with FTP access for monitoring and logging functions. Saia PCD® COSinus operating system for automation/MSR technology developed by Saia Burgess Controls.



### 2.3 Saia PCD® Web Panel MB | Standard devices

Page 86

Operation of HMI applications is also possible from multiple connected Saia PCD® automation stations. The applications are created using Saia PG5® Web Editor and made available in the web server of the Saia PCD® automation devices for the Web Panel Micro-Browser (MB).

[Device series accessories](#) → Section 2.5 – page 90



### 2.4 Saia PCD® pWeb Panel MB

Page 88

In addition to the functions of the standard MB panel, a freely programmable logic controller is integrated. Specific, complex operating and local data processing logic can be realized. A large number of connected Saia PCD® automation stations can be shown at a higher level.

[Device series accessories](#) → Section 2.5 – page 90



### 2.6 Industrial Web Panel with Windows® operating system

Page 94

Control panel for web visualizations with Windows®: Saia PCD® Web Panels are specially based on the requirements of web visualizations and are preconfigured with all the applications and software tools needed. There is no need for laborious installation and software updates. Saia PCD® Web Panels are ready to use immediately.



### 2.7 Overview of semi-graphic displays

Page 96

Ideal for simple applications and series machines. Programmed using the Saia PG5® HMI Editor software tool. Classic HMI technology – every HMI device is connected to a control device.



## 2.1 Overview of types, sizes and resources

### Saia PCD® Web Panel MB | Standard devices

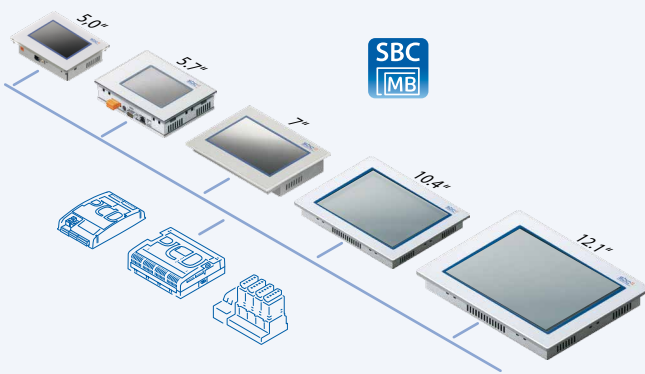

#### Saia PCD® Web Panel MB | Standard devices

Robust control panel for displaying web visualizations created with the Saia PG5® Web Editor.

Ready to use immediately without any software installation.

#### Display sizes 5.0" / 5.7" / 7.0" / 10.4" / 12.1"

- ▶ Ethernet, USB and serial
- ▶ FTP server
- ▶ File system

### Saia PCD® pWeb Panel MB | with programmable logic controller

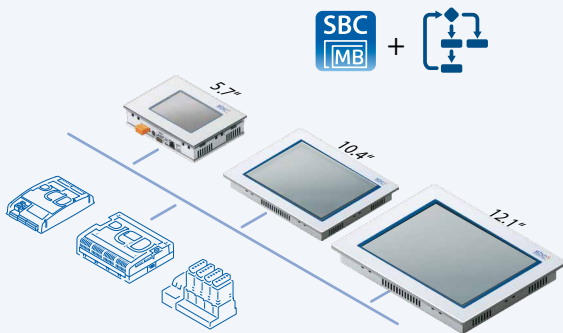

#### Saia PCD® pWeb Panel MB | with programmable logic controller

The programmable Web Panel combines an Automation Server for visualization with control and management functions in one device.

#### Display sizes 5.7" / 10.4" / 12.1"

- ▶ 2x Ethernet (switch), USB and RS-485
- ▶ Integrated logic controller
- ▶ Programmable with Saia PG5®
- ▶ Automation Server
- ▶ 128 MB of flash memory

### Saia PCD® Web Panel MB – Functional HMI | Visualization and operation with ready-to-use functions

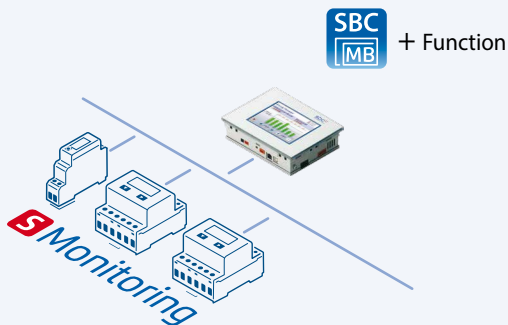

#### One step closer to the application

Functional HMI systems provide functions which support the user in the implementation of complex applications such as recording and visualizing data records. Here, the devices already have an application installed. This can be modified or expanded.

→ For more information, see Chapter 4

### Devices with Windows® operating system

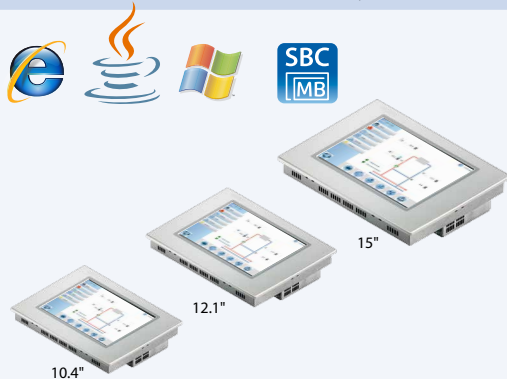

#### Industrial Web Panel with Windows® operating system

For complex visualizations, functions can be expanded using JAVA or .Net components. Access to standard websites

#### Display sizes 10.4" / 12.1" / 15"

- ▶ Visualization using Micro Browser technology
- ▶ 2x Ethernet, USB and serial
- ▶ 500 MHz and 1.6 GHz CPU
- ▶ Web, FTP and VNC server
- ▶ Windows® CE 6.0 and Windows® eXP

## 2.2 Saia PCD® Web Panel MB | Web technology

### Combination of openness, world standards and universality

A system for operation/monitoring with web technology consists of essentially just two functional elements: a web server and a browser. The protocol linking them is http. These two functional elements can be combined in the same automation device or can be located on opposite sides of the globe.

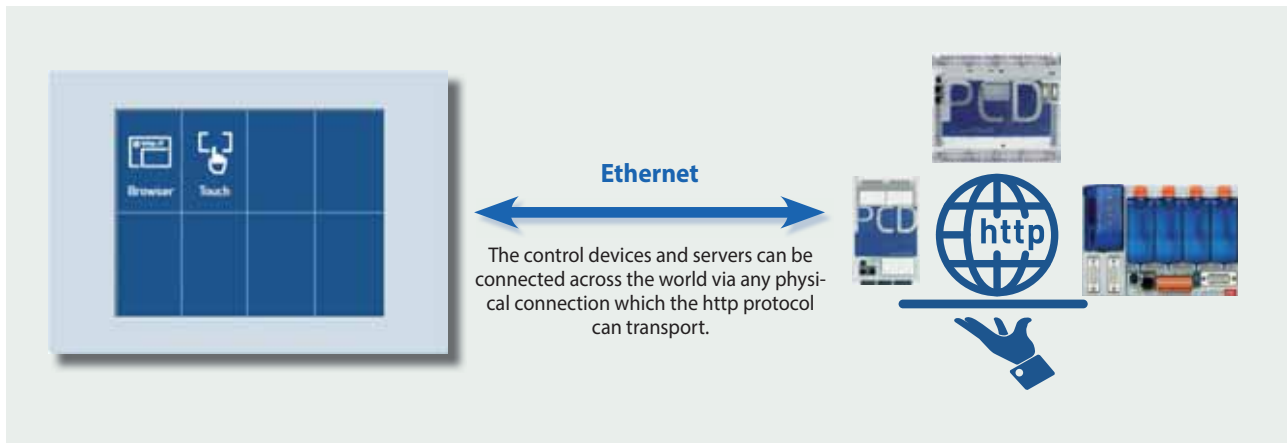

The operation/monitoring project is created once using Saia PG5® Web Editor and saved to the associated web server. Every browser can freely access any web server of the automation devices recognized in the network and run its Web-HMI application. A web server can handle multiple browsers at the same time. Web-HMI eliminates complex engineering, duplication of project expenses, software licensing problems and system breaks during operation/monitoring.

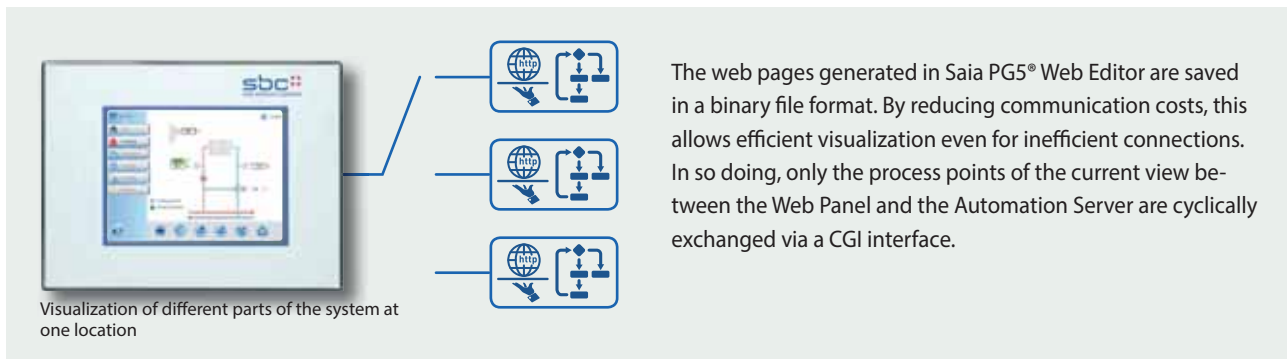

### Saia PCD® COSinus



Saia PCD® COSinus

Systems are often extended or fitted with new functions and must be maintained throughout their entire lifecycle. The Saia PCD® COSinus operating system was specially developed from scratch in-house for use in automation environments. It is

therefore possible to ensure the industrial lifecycle without being pushed by large market-influencing companies. The top priority for Saia PCD® COSinus is reliable and continuous operation.

The SBC Micro Browser Panel series are essentially based precisely on this reliable system which has been expanded

with the Micro-Browser application. This allows the visualization and operation of web projects which have been created with Saia PG5® Web Editor. Here, the visualization project can be saved locally or on a remote server.

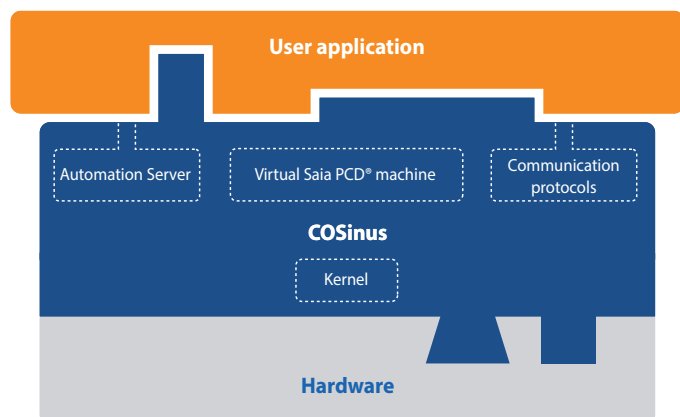

1 Automation stations

2 HMI Visualization and operating

3 Dedicated room controller

4 Consumption data acquisition

5 Cabinet components

## 2.3 Saia PCD® Web Panel MB | Standard devices

The Micro-Browser standard device series is the visualization and control interface for automations with Saia PCD® controllers. The panels – finished to industrial quality – are available in various sizes in order to deal with different requirements. Thanks to the internal memory, all devices enable data trending and alarm history in such a way that dynamic visualization can be implemented. An application saved in the controller can be displayed on the panel without any additional configuration tool.

### Main characteristics

- ▶ Large selection of display sizes, color TFT display, in VGA or SVGA resolution
- ▶ Fast and easy commissioning without additional applications with internal setup menu
- ▶ Connection to the web server via Ethernet

### Equipment assembly

#### 5.0 and 7.0" inch

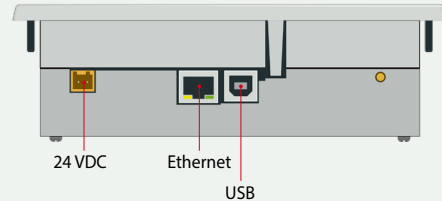

\* In preparation, see chapter C2 Status

### Unit Structure

#### 5.7 inch / 10.4 inch

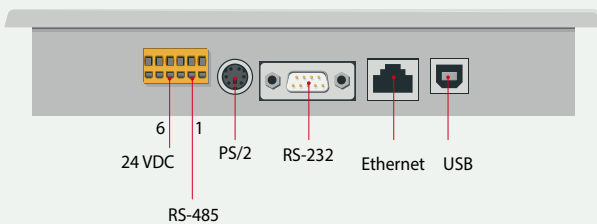

#### 12.1 inch

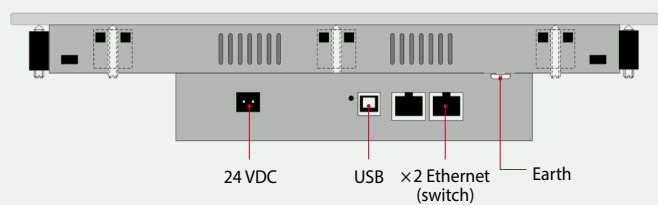

### EPLAN macros

EPLAN macros are available for project planning and engineering



ePLAN® electric P8 macros are available from the support page.

Macros and product data may also be obtained from the ePLAN® data portal.

### SBC MB App

Operation and monitoring on iPhone, iPad and Android



### Setup menu

The panel is configured in two stages via the Setup menu directly on the panel. No additional software or a connection to a laptop is required for commissioning.

#### Stage 1: Network configuration

Setup	Network	Help
Enable DHCP		<input type="checkbox"/>
TCP/IP Address	192.168.12.201	>
Subnet mask	255.255.255.0	>
Default gateway	0.0.0.0	>
Primary DNS Server	0.0.0.0	>
Secondary DNS Server	0.0.0.0	>

#### Stage 2: Web server configuration

Connection List	Edit Connection
Connection Name	conn_1.http >
Start Page	macro.html >
Remote host IP	192.168.12.200 >
Remote port	80 >



## Dimensions (W × H × D) and cut-out (W × H) mm

## PCD7.D450WTPF

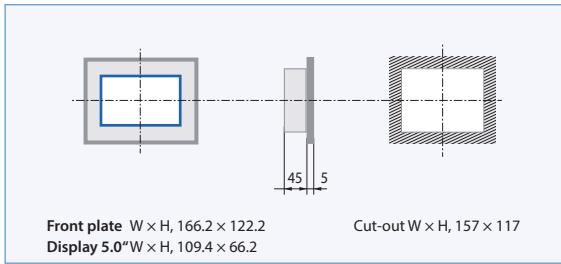

## PCD7.D410VTCF

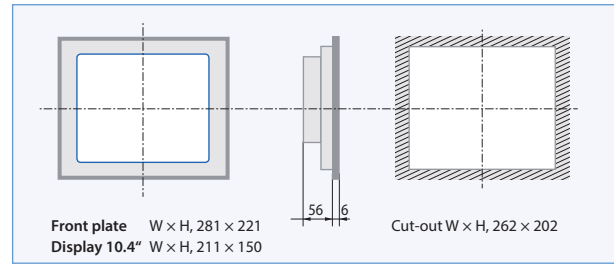

## PCD7.D457VTCF

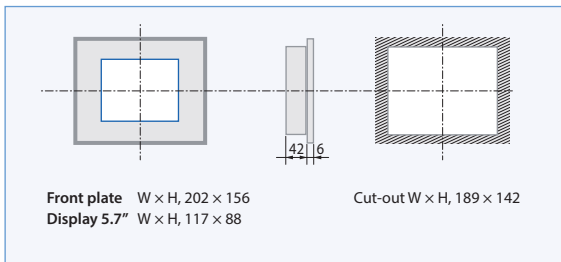

## PCD7.D412DTPF

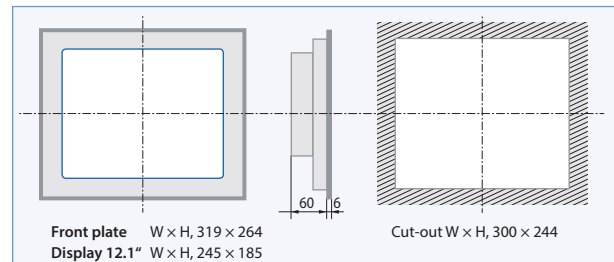

## PCD7.D470WTPF\*

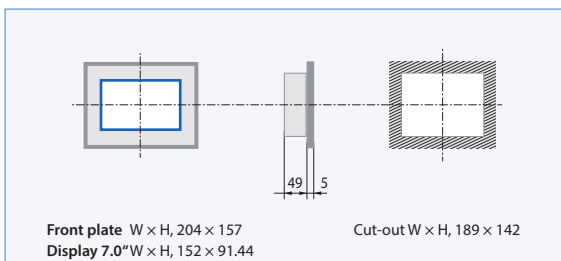

## General data

## User interface

Operating system	Saia PCD® COSinus with Micro-Browser expansion
Protection type (front)	IP 65
Temperature range	Operation: 0...50 °C, (7.0": -25...+70 °C) Storage: -25...+70 °C
Humidity	Operation: 10...80 %, Storage: 10...98 %, non-condensing
Contrast adjustment	Yes
FTP server	Yes
Supply voltage	24 VDC ±20 %



## Technical data

	PCD7.D450WTPF	PCD7.D457VTCF	PCD7.D470WTPF*	PCD7.D410VTCF	PCD7.D412DTPF
Display size	5.0" TFT	5.7" TFT	7.0" TFT	10.4" TFT	12.1" TFT
Resolution (pixels)	WVGA 800 × 480	VGA 640 × 480	VGA 800 × 480	VGA 640 × 480	SVGA 800 × 600
Touch screen	Resistive touch screen	Resistive touch screen	Resistive touch screen	Resistive touch screen	Resistive touch screen
Background lighting	LED	LED	LED	LED	LED
Colors	65,536	65,536	65,536	65,536	65,536
On-board file system	128 MB	4 MB flash	128 MB	4 MB flash	128 MB
Processor	240 MHz	66 MHz	240 MHz	66 MHz	240 MHz
Interfaces	USB 1.1/2.0, Ethernet 10/100 M	RS-232, RS-485, USB 1.1, Ethernet 10/100 M	USB 1.1 Device, Ethernet 10/100 M	RS-232, RS-485, USB 1.1, Ethernet 10/100 M	USB 1.1/2.0, Ethernet 10/100 M
Current requirements	350 mA	approx. 500 mA	400 mA	approx. 500 mA	approx. 600 mA
Real-time clock (RTC)	Yes (Super-Cap)	No	Yes (Super-Cap)	No	Yes (Super-Cap)

\* In preparation, see chapter C2 Status

## 2.4 Saia PCD® pWeb Panel MB

In addition to the functions of the standard MB panel, a programmable logic controller is integrated into the pWeb-Panels. Based on the COSinus operating system of the Saia PCD®, specific, complex control logic and local data processing logic can be implemented in one device. The priority here is the operating and visualization functions so that small control systems can also be implemented. The control functions have a lower priority.

### Main characteristics

- ▶ 2x Ethernet interfaces (switch)
- ▶ RS-485 interface
- ▶ 240 MHz processing power
- ▶ Expandable via PCD7.F1xxS modules
- ▶ Usable as RIO master



### Installation

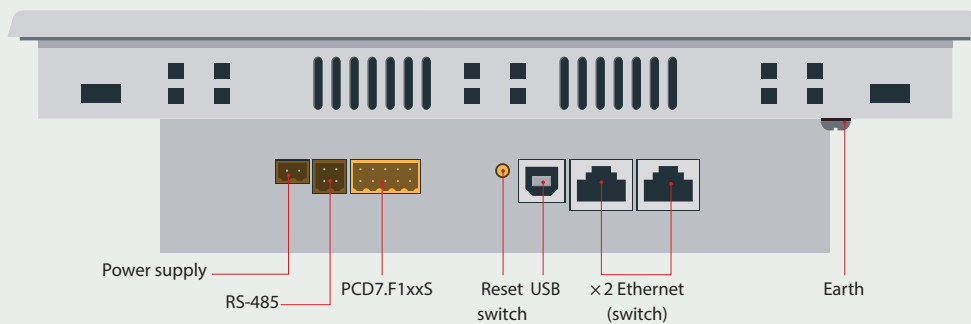

The high priority given to visualization in the program workflow offers the best basis displaying data from various devices. In addition, simple control tasks can be implemented directly in the panel. It is not advisable to use pWeb panels when constructing closed control loops or utilizing HVAC and DDC Suite controllers. In these cases, a Saia PCD® controller is recommended.

### Application examples

#### Data concentrator

The logic enables the values and statuses of a large number of connected Saia PCD® automation stations to be collected, linked and then visualized at a higher level.

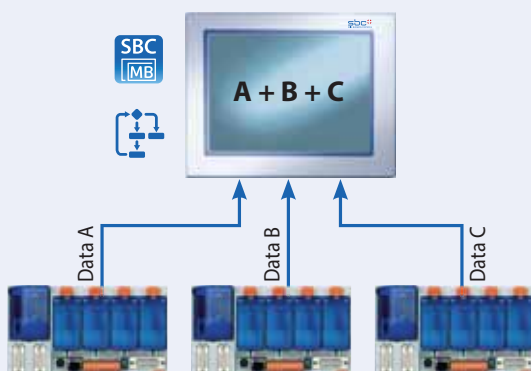

#### Decentralized automation

Values of any type can be counted and displayed by loading the S-Monitoring application. Each system's consumption is thereby made transparent. For more information, see chapter „Acquisition of Consumption Data“

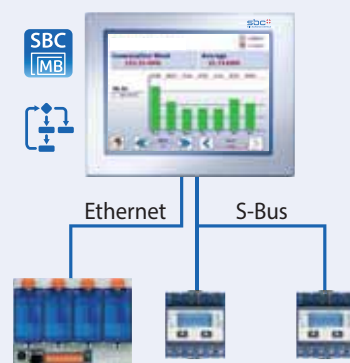

## Dimensions (W × H × D) and cut-out (B × H) mm



### PCD7.D457VT5F

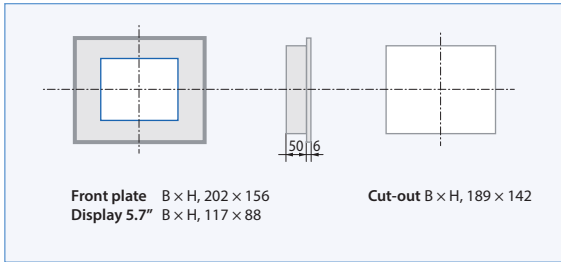

### PCD7.D410VT5F

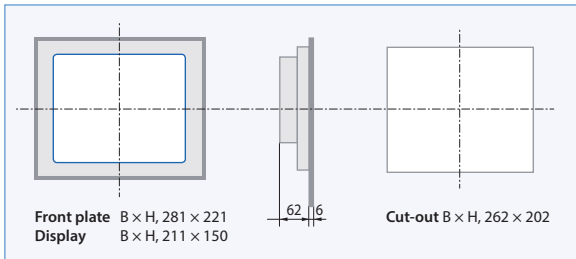

### PCD7.D412DT5F

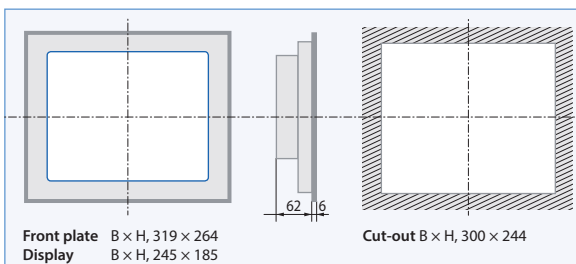

## Logic controller

Operating system:	Saia PCD® COSinus with Micro Browser extensions
Protection class	IP65
User program, ROM/DB/Text	1 MByte
RAM/DB/Text	1 MByte
Media	16,384 flags / 16,384 registers
Backup for users	The user program is saved on the integrated microSD card
File system for users	128 MByte onboard
Program cycle time	10 cycles/sec. maximum
Protocols at field level	Serial-S-Bus, Ether-S-Bus, Ether-S-IO, Modbus RTU or TCP
Internet services	SBC Micro Browser, Automation Server

## Interfaces

Ethernet	2 × RJ-45 (Switch)
USB	1 × (1.1 / 2.0)
Serial interfaces	RS-485 1 slot for PCD7.F1xxS
Temperature range	Operation: 0 ... 50°C (typically) Storage: -25 ... 70°C
Humidity	Operation: 10 ... 80%, Storage: 10 ... 98%, non-condensing
Processor	Coldfire CF5373L 240Mhz
Battery	Lithium Renata CR 2032 (lifetime of 1...3 years)
Real-time clock (RTC)	through battery backup

## Technical data

	PCD7.D457VT5F	PCD7.D410VT5F	PCD7.D412DT5F
Display size	5.7" TFT	10.4" TFT	12.1" TFT
Resolution (pixels)	VGA 640×480	VGA 640×480	SVGA 800×600
Touch screen	Resistive touch screen	Resistive touch screen	Resistive touch screen
Contrast adjustment	Yes	Yes	Yes
Background lighting	LED	LED	LED
Power supply	24 VDC ±20%	24 VDC ±20%	24 VDC ±20%
Current draw	max. 500 mA	max. 500 mA	max. 600 mA
Status front LED	---	---	Yes

## Communication

The Saia PCD® pWeb Panel MB units can be expanded with one slot for PCD7.Fxxx modules or PCD7.Rxxx modules with various communication and memory modules.

The modules are described in the section "1.4 Saia PCD1 series".

## 2.5 Accessories for Micro-Browser Panels

### The right mounting kit for all Web-HMI devices

The Micro-Browser Panel series not only fits in a switch cabinet but, using industrial in-wall and off-wall mounting kits, enables this modern technology to be easily and properly integrated into the area in close proximity to the user as well. The mounting kits therefore enable simple wall mounting, which is consistently available for all panels. This minimizes logistic and mounting costs.

#### 5.7 inch / 7 inch

**In-wall mounting**  
PCD7.D457-IWS2



**On-wall mounting**  
PCD7.D457-OWS2

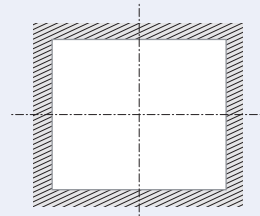

**Cut-out**  $B \times H, 270 \times 211$   
Minimum depth  
For solid walls 75 mm  
For cavity walls 65 mm

#### 10.4 inch

**In-wall mounting**  
PCD7.D410-IWS



**On-wall mounting**  
PCD7.D410-OWS

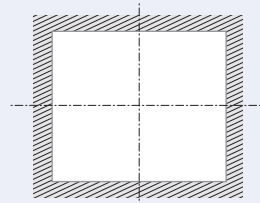

**Cut-out**  $B \times H, 270 \times 211$   
Minimum depth  
For solid walls 75 mm  
For cavity walls 65 mm

#### 12.2 inch

**In-wall mounting**  
PCD7.D412-IWS



**On-wall mounting**  
PCD7.D412-OWS

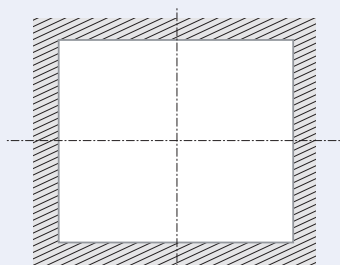

**Cut-out**  $B \times H, 309 \times 245$   
Minimum depth  
For solid walls 75 mm  
For cavity walls 65 mm

### On-wall mounting kit 5.7 inch / 7 inch

#### On-wall mounting

PCD7.D457-OWS

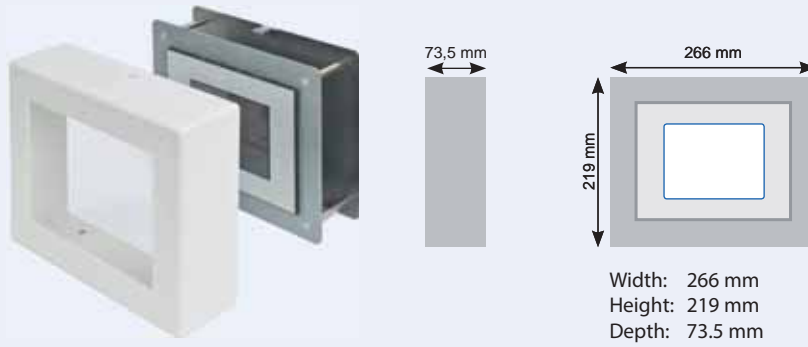

### Wall mounting kit 5.7 inch / 7 inch

PCD7.D457-OWS1

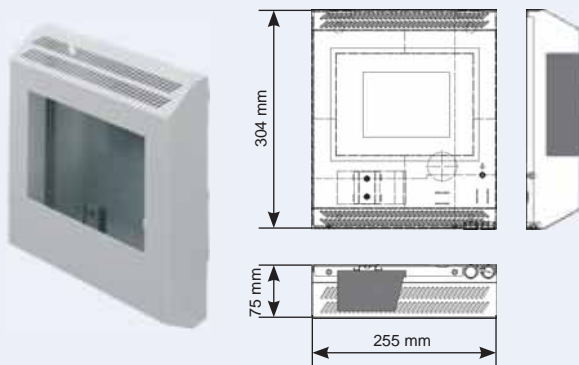

### OEM or proprietary design

The standard 5.7 inch Micro-Browser Panel without a front panel offers room for individual creativity. Whether it's for modern rooms or rustic spaces with customer-specific front screens designed in aluminum, black or wood, this modern technology can be easily and unobtrusively integrated into a sophisticated space.



Panel with aluminum front: PCD7.D457VTCZ33  
 Panel with black front: PCD7.D457VTCZ35  
 Panel with mirror-effect front: PCD7.D457VTCZ36  
 Panel with neutral film: PCD7.D457VTCZ11

1 Automation stations

2 HMI Visualization and operating











3 Dedicated room controller

4 Consumption data acquisition

5 Cabinet components

## 2.5.1 Micro-Browser App for Apple and Android

The Micro-Browser apps breaks the limitations of the industrial world. Most tablets or smartphones are optimized for a long mobile runtime with high performance. The Micro-Browser App is therefore the ideal way to fill the gap between stationary and mobile areas of use. This provides the foundation for 24-hour monitoring and direct intervention in system operation.

				
Technical data	SBC MB light	SBC MB	SBC MB Energy Manager	SBC MB
Operating system version	 > iOS version 3.2			 > Android V.2.2
Resolution/pixels	Depends on the devices used			
Update management	AppStore			Google Play
Restrictions	No station list No URL jump	No restrictions	For Energy Manager only	No restrictions
				

## 2.5.2 Saia PCD® Web Panel MB | Standard devices

### TFT displays: LED service life

The STN LCD displays have the system property whereby the displays can only be easily read when viewed from the front while standing vertically. In addition, the visibility of devices with CCFL backlights is restricted in bright light. Setting the maximum contrast generally compensates for this. However, this shortens the service life of the LCD display, which therefore needs to be replaced once or twice over the system lifecycle. The TFT LCD displays built into the Saia PCD® Web Panel MB ensure – using LED backlighting – a long life and good readability over a long period of time.

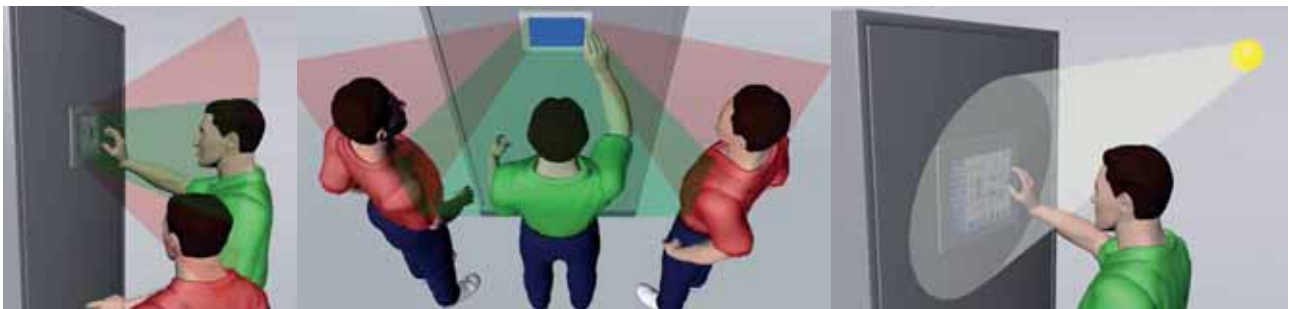

▲ System properties of STN LCDs: poor visibility when viewed from an angle

▲ Poor visibility in brightly light surroundings

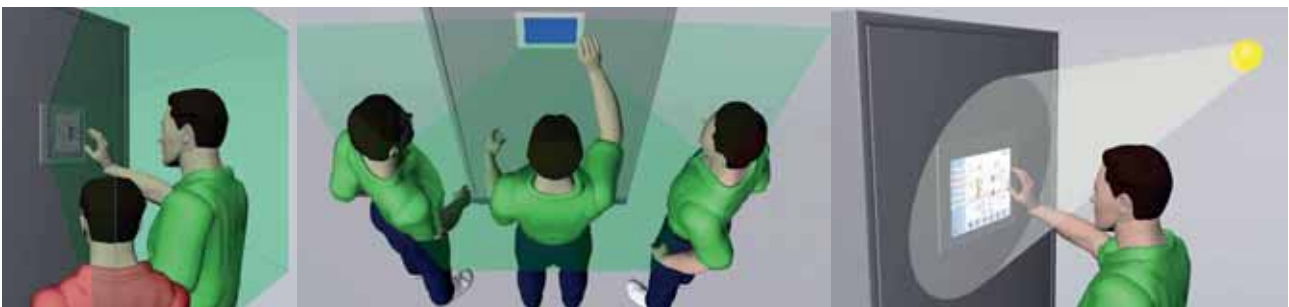

▲ System properties of TFT LCDs: good readability from any angle and sharp images in bright light



## 2.5.3 Practical example of a wall mounting set | Lucerne Exhibition Center

Control panels easily integrated into the building using the wall mounting set.

In the example of the Lucerne Exhibition Center, 2 control panels were placed in concrete walls and wooden doors using the wall mounting set. The individual front frames enable the color to be adjusted to the background.



▲ External facade in accordance with Minergie standard



▲ Easy integration of the control panels into concrete and wooden walls in the example of the Lucerne Exhibition Center

## 2.5.4 Ways of using the Web-Panels with S-Web technology

Using S-Web technology combined with the Micro-Browser Panel systems, operation can be made transparent and clear for all users. Each individual operating side has a fully flexible design and can be created using the standard objects or existing function templates.



▲ DDC Suite / HVAC templates created with Saia PGS® Web Editor 8



▲ My HMI: Web pages created with Saia PG5® Web Editor 8

For further information, see the "S-Web technology" section

1 Automation stations

2 HMI Visualization and operating

3 Dedicated room controller

4 Consumption data acquisition

5 Cabinet components

## 2.6 Web Panel with Windows® operating system

### Control panel for web visualizations with Windows®

Saia PCD® Web Panels are specially based on the requirements of web visualizations and are preconfigured with all the applications and software tools needed for this. There is no need for laborious installation and software updates. Saia PCD® Web Panels are ready to use immediately.



### Main characteristics

- ▶ Preconfigured and ready to use for web visualizations, optimized for Saia PCD® controllers
- ▶ 10"/12"/15" color TFT display with 16.7 million colors and touch operation
- ▶ 2x Ethernet
- ▶ Without fan and hard drive

### PCD7.D51xxTL010 Web Panel series

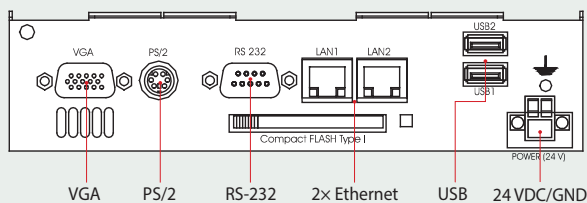

### PCD7.D6150TA010 Web Panel

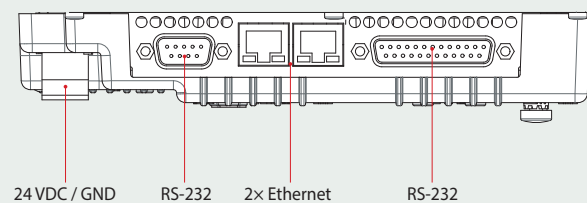

### SBC.Net: Toolboxes for web visualization and high-level language programming

The preinstalled SBC.Net offers a range of add-on functions which simplify the use of web visualizations and support the use of Saia PCD® technologies in conjunction with high-level language programming.

Web-Connect ensures simple and efficient communication between panels, controllers and the Internet. With the Web-HMI server, high-level language programs can be expanded to include a web interface and can thus be easily operated by a web browser. The Web-Panels are fitted with .Net Compact

Framework and present an ideal platform for Visual Basic and C# programs. Definition of communication links with Web-Connect using a web interface via Internet Explorer.



### Simple panel configuration

With Web Panel Configurator, the Web Panel can be adapted to the relevant application in an instant. Using an intuitive user interface, all the settings can be made logically step by step. Starting with the network configuration, through to selecting the web visualization to be shown and the browser settings associated with it, the multilingual software tool makes it easy to configure the Web Panel without any knowledge of Windows®.



## Dimensions (W × H × D) and cut-out (W × H) mm

### PCD7.D5100TL010

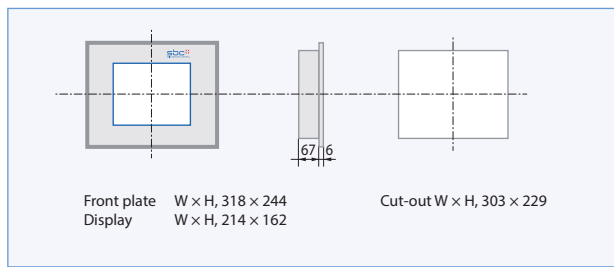

### PCD7.D5120TL010

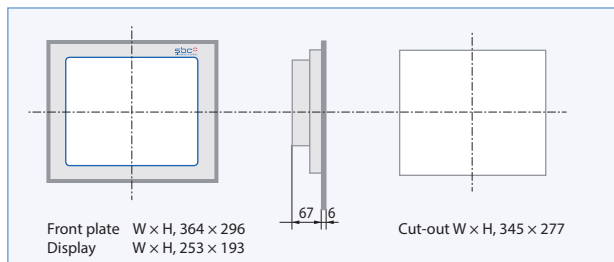

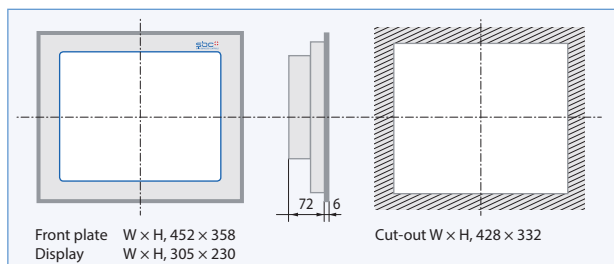

### PCD7.D6150TA010





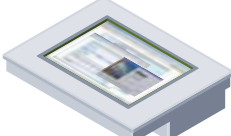

## General data

Protection type (front)	IP65
Web/FPT/VNC/File Server	Yes
Supply voltage	24 VDC ±20%
Ethernet	2× Ethernet Ports RJ-45
Serial	RS-232 D-Sub 9-pole
Applications	JAVA Runtime, Micro-Browser
Ambient temperature	Operation: typically 0...50°C Operation: -20...60%
Atmospheric humidity	Operation: typically 10...75°C, Storage: 10...95% non condensing
Touch-screen	Resistive touch-screen

			
Technical data	PCD7.D5100TL010	PCD7.D5120TL010	PCD7.D6150TA010
Display size (inch)	10.4"	12.1"	15"
Resolution (pixels)	SVGA 800 × 600		XGA 1024 × 768
CPU	533 MHz / AMD Geode LX 800		1.6 GHz / Intel Atom Z530
Main memory	256 MB		1 GByte
Internal ROM (HDD)	128 MB CFC slot		4 GByte SSD
Expandable ROM (HDD)	CFC slot		SD card
Current draw	approx. 0.9 A	approx. 1.1 A	normal 1.5 A, maximum 1.7 A
USB	×2 USB 2.0, host		USB 2.0 Host (500 mA)
PS/2	1 × Mini DIN PS/2		---
Monitor	1 × VGA		---
Operating system	Windows® CE 6.0 R3		Windows® eXP:
.Net	Compact Framework		Framework

## 2.7 Overview of semi-graphic displays

Text information can be displayed on semi-graphic Text-Panels and, depending on the model, graphical elements may also be displayed. As these semi-graphic Text-Panels do not have their own memory, all information to be displayed is transferred from the automation station to the panel for display as and when required.

				
	4 lines × 16 chars.	8 lines × 20 characters with graphics capability		
Display	PCD7.D170	PCD7.D230	PCD7.D231	PCD7.D232
Colors	mono	mono	mono	mono
Display type	Text	Graphic	Graphic	Graphic
Lines × characters	4 lines × 16 chars.	8 lines × 20 chars.	8 lines × 20 chars.	8 lines × 20 chars.
Resolution	---	128 × 64 pixels	128 × 64 pixels	128 × 66 pixels
Background lighting	LED on/off	LED on/off	LED on/off	LED on/off
Character size (W×H)	3 × 4.7 mm	2.5 × 3.5 mm	2.5 × 3.5 mm	2.5 × 3.5 mm
Character set	ASCII + spec. E, D, F, Sca	ASCII (West European) and Cyrillic	ASCII (West European) and Cyrillic	ASCII (West European) and Cyrillic

### Keyboard

Total keys	5	1 dial knob	10	25
Function keys and buttons	5 F-keys <sup>4)</sup> or 5 keys	---	5 F-keys or 5 keys	8 F-keys+num. Keyboard
Key autorepeat	Yes	No	Yes	Yes
Buzzer	No	Yes	Yes	Yes
LED status	No	No	No	8

### Memory (PCD/PCS1)

	depending on PLC	depending on PLC	depending on PLC	depending on PLC
--	------------------	------------------	------------------	------------------

Clock	on PLC	on PLC	on PLC	on PLC
-------	--------	--------	--------	--------

### Interfaces

	RS-232	RS-232/422/485	RS-232/422/485	RS-232/422/485
Log	Point-to-point	Point-to-point	Point-to-point	Point-to-point

### Programming software

	HMI-Editor <sup>2)</sup>	HMI-Editor	HMI-Editor	HMI-Editor
Graphical display options	No	Yes <sup>1)</sup>	Yes <sup>1)</sup>	Yes <sup>1)</sup>
Autorepeat function	Yes	---	Yes <sup>3)</sup>	Yes <sup>3)</sup>
Function key commands	Yes <sup>4)</sup>	---	Yes <sup>3)</sup>	Yes <sup>3)</sup>
LED control commands	---	---	---	yes <sup>3)</sup>
Buzzer control commands	---	Yes <sup>3)</sup>	Yes <sup>3)</sup>	Yes <sup>3)</sup>

### General data

Supply voltage	24 VDC ±20%	24 VDC ±20%	24 VDC ±20%	24 VDC ±20%
Protection type (front)	IP 65	IP 54	IP 65	IP 65
Dimensions (W×H×D) [mm]	120 × 110 × 45	115 × 125 × 45	115 × 125 × 45	115 × 125 × 45
Cut-out (W×H) [mm]	109×99	99×109	99×109	99×109

<sup>1)</sup> with RS-232 RTS/CTS, XON/XOFF reduced, RS-422 XON/XOFF reduced

<sup>2)</sup> only with "shift key" setup mode

<sup>3)</sup> not with FTP mode (RS-485)

<sup>4)</sup> function keys are not supported by the HMI-Editor

<sup>5)</sup> icon with RS-232

# A3

## Dedicated room controller

Room controllers with a preconfigured regulation and control program which can be comprehensively parameterised via network communication and tailored to meet individual needs. Fully independent functionality is still guaranteed even without a bus connection.



### 3.1 Project planning and Engineering

Page 98

- ▶ Saia PG5 FBoxes, SBC S-Web
- ▶ Efficiency in project realisation
- ▶ Multiple application possibilities



### 3.2 Saia PCD7.L79xN compact room controller with S-Bus

Page 102

- ▶ Heating/cooling
- ▶ Integrated operation and temperature measurement



### 3.3 Saia PCD7.L6xx combinable room control system with S-Bus and LonWORKS®

Page 104

- ▶ Heating/cooling
- ▶ Fan coil
- ▶ Air quality control
- ▶ Light and shade



### 3.4 Operation systems

Page 108

- ▶ Wired (analogue, digital, touchscreen)
- ▶ Wireless (infrared, radio, EnOcean receiver)
- ▶ Standard interfaces (e.g. web-based or LonWORKS from external manufacturers)



1 Automation stations

2 HMI Visualization and operating

3 Dedicated room controller

4 Consumption data acquisition

5 Cabinet components

## 3.1 Project planning and engineering

In addition to the freely programmable controllers, the range of products for room-specific applications also includes dedicated SBC room controllers.

### Key features

#### ► Application software included on delivery

The room controllers can be parameterised via network communication and fully independent functionality is still guaranteed without a bus connection.

#### ► Efficient integration for suitable applications

Use of HVAC applications in zones and room automation systems which adjust the I/O mix and integrated applications precisely to the specific application. As the room controllers are not freely programmable, unsuitable applications should be realized with a solution which includes the «PCD1.Room».

#### ► S-Bus room controllers are integrated in the Saia world

The Saia FUPLA (FBoxes) allow engineering in the standard SBC environment and make use of the benefits of the Saia PG5 Controls Suite.

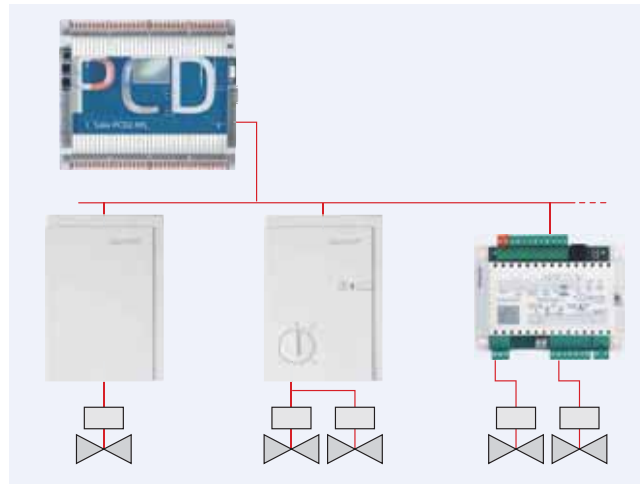

Parameterised via bus with Saia PG5 Controls Suite

## Engineering information

### Commissioning the SBC S-Bus and Lon room controller



If the room controller is used as part of a SBC S-Bus network, addressing and configuration is carried out by the Saia PCS/PCD-Master using the Saia PG5 Controls Suite. Practical FBoxes simplify commissioning.

The FBox setup and room controller service pin are used for the addressing process. It is recommended pre-addressing the room controller in the office.



If the room controller is used in an Lon network, the configuration is performed using an LonWORKS® tool such as the NL220 or LONMAKER®.

### Integrating the SBC S-Bus room control system with S-Engineering using function modules (FBoxes)

- Programming and debugging environment are combined in the same tool.
- Complex user programs are created by simply placing and linking FBoxes without the need for in-depth programming knowledge.
- Online visualisation of the process variables and online settings of the parameters direct in the FBoxes simplifies the commissioning process.

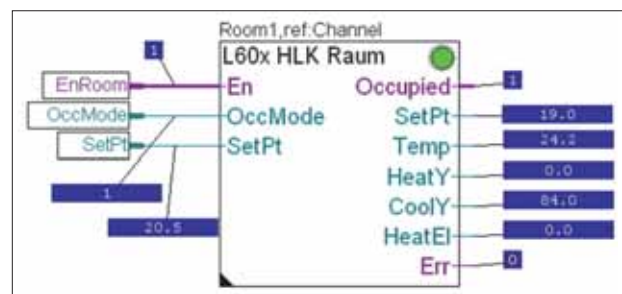

Online visualisation of the HVAC room FBox.

- The parameter windows of each of the FBoxes can be used to display online and directly adjust all setpoint values, actual values and statuses of the controller.
- Detailed, context-sensitive FBox information, clear descriptions and graphical representations in the function chart editor (FUPLA) give clear, easy to read programs.
- It is possible to switch all control parameters to a control system using the PCD controller, and thus reduce running costs.



**Efficiency in project realisation**

The FBoxes shorten the «Engineering duration» and simplify the commissioning process since the configuration data can be sent via the communication interface to up to 250 controllers in just one single step. The automatic detection of the communication speed also simplifies the commissioning process.

**Multiple application possibilities**

Application programs for various types of systems are already preprogrammed in the controller and can be activated using the parameterisation.

**Parametrisable application programs**

If the delivered application does not meet the project requirements, the PG5 FBoxes or S-Web can be used to activate and parameterise the application program for various types of system. The application software already contains several user programs for systems such as combined radiators/cooling ceiling systems.

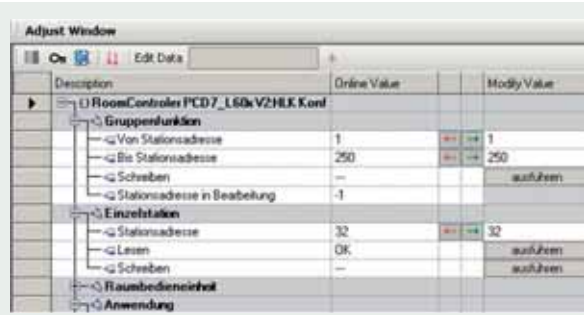

Configurable using the PG5 Controls Suite



The control parameters (PI) for the specific applications can be adjusted and optimised.

**Fully independent functionality guaranteed even without bus connection**

Once the application programs in the controller have been parameterised, it is possible to run a fully independent operation without a PCD. This means that the controller will continue to operate uninterrupted even if communication with the Saia PCD® automation station is disrupted. All of the set configuration parameters are written to the EEPROM and remain stored there even without operating voltage.

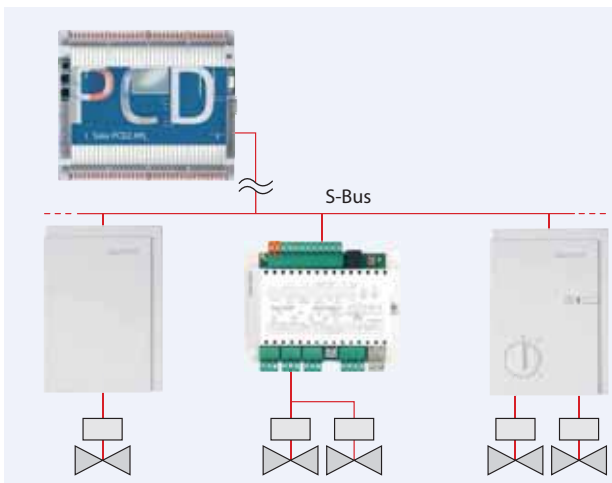

Functionality is also guaranteed in the event of a bus fault.

**SBC S-Web**

Web Editor macros simplify the efficient setup process of web-based commissioning, operation and service operating concepts.

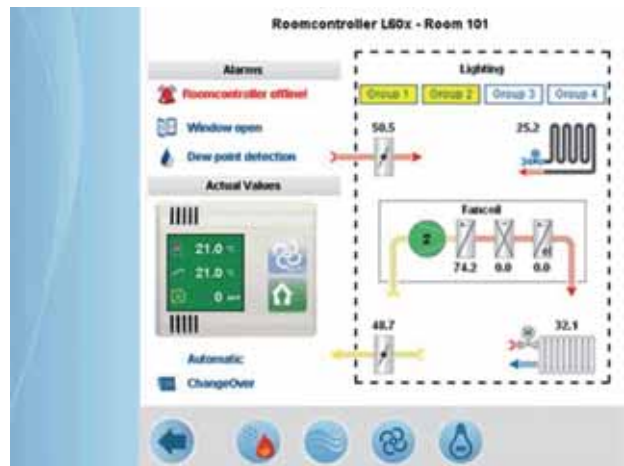

Visualisation and operation of the room parameters using the web server

This makes local operation using a PC workstation possible. The password protected control screens are loaded directly from the web server integrated in the automation station and displayed.

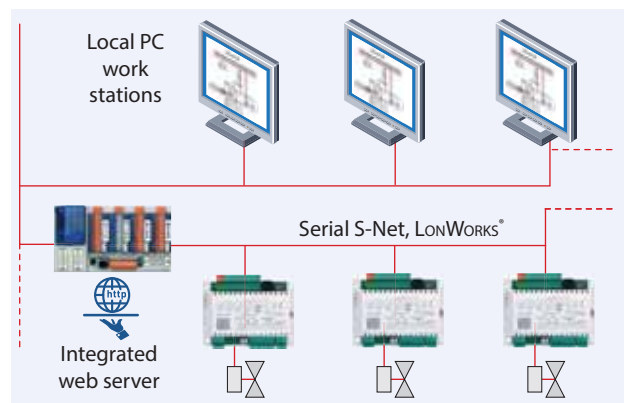

Local user prompts from PC workstation.

1 Automation stations

2 HMI Visualization and operating

3 Dedicated room controller

4 Consumption data acquisition

5 Cabinet components

## Project planning information

### Bus terminating resistor and bus cable for serial S-Net (S-Bus/RS-485)

S-Bus cables must be installed as a line. Stub lines are not permitted and both ends of the cable must be terminated with a resistor (approx. 120 Ω) between the D and /D cables. The best signal quality is achieved using an active bus connection with a resistor to +5V and ground.

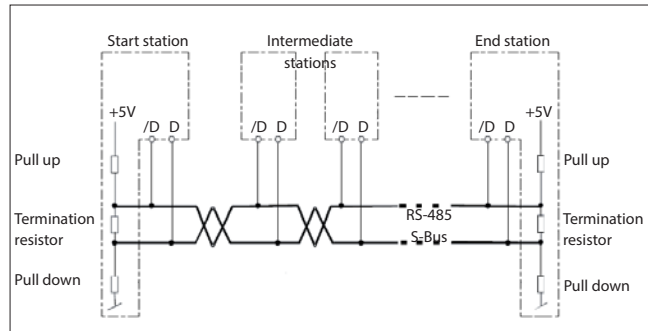

Schematic illustration of an S-Bus/RS-485 bus



With S-Bus controllers, the 111 configuration register can be used to activate the integrated active bus termination resistor or an external PCD7.T161/2 termination box can be used.  
Bus cable: a 2-strand twisted and shielded bus cable with cable strands of at least 0.5 mm<sup>2</sup> must be used. For additional information please refer to the S-Bus manual 26/739 (available on [www.sbc-support.com](http://www.sbc-support.com)).

### Maximum number of room controllers

The maximum number of room controllers which can be managed by a PCS/PCD system depends on the maximum electrical load of the serial S-Net, the bus system cycle time and the resources used by the functional objects.

#### PCD7.L79xN

Resources: max. 600 program lines per FBox, max. 40 registers per FBox, max. 16 flags per FBox. 1 DB  
Bus cycle timer per controller: approx. 15 ms

#### PCD7.L60x-1 (with all FBoxes maximum removable)

Resources: max. 95 registers, max. 36 flags  
Bus cycle timer per controller: approx. 80 ms

At a communication speed of 38'400 baud, the communication time for a controller is approx. 15 ms, or 80 ms. If the PCD program requires longer than 15 ms or 80 ms per PCD cycle, this value must be used as the basis of the calculation used to estimate the communication cycle. For additional information please refer to chapter 1.1.

Communication cycle = «15 ms or 80 ms per controller» × «Number of controllers».



**Recommendation: max. 4 S-Bus interfaces with up to 25 room controllers per interface so that in the majority of cases the resources are sufficient and the communication cycle time remains at < 2 seconds.**

### Types of use and modes of operation

The function of the room controller is based on various types of use or modes of operation. Each of the selectable modes of operation can be assigned different control parameters.



#### Safety mode/Frost protection

No heating or cooling energy is fed into the room. This state is desirable if a window is open. The room controller keeps the room temperature above the preset frost line of 8° C.



#### Non-use/reduced

Reduced operation mode which is used when the the room is not occupied for a long period. In this operation mode, the specified setpoint value offset is not active.



#### Standby

The room is prepared for use but no presence has yet been registered in the room. As long as the room is not classified as occupied by the presence function, the room controller keeps the room temperature within the specified limits at the standby temperature.



#### Use/Comfort

The room is used and should be brought to the comfort temperature. This state can be reached by pressing the presence button, reacting to an external presence detector or a parameter on the network side.

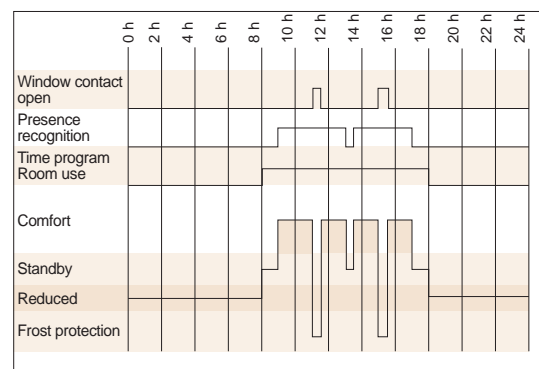

Example: Operating mode switchover

## Control parameters

The adjacent illustration depicts a selection of the most important adjustable control parameters of a PCD7.L60x-1 controller. Other parameters such as the reset times, threshold values, etc. can also be adjusted.

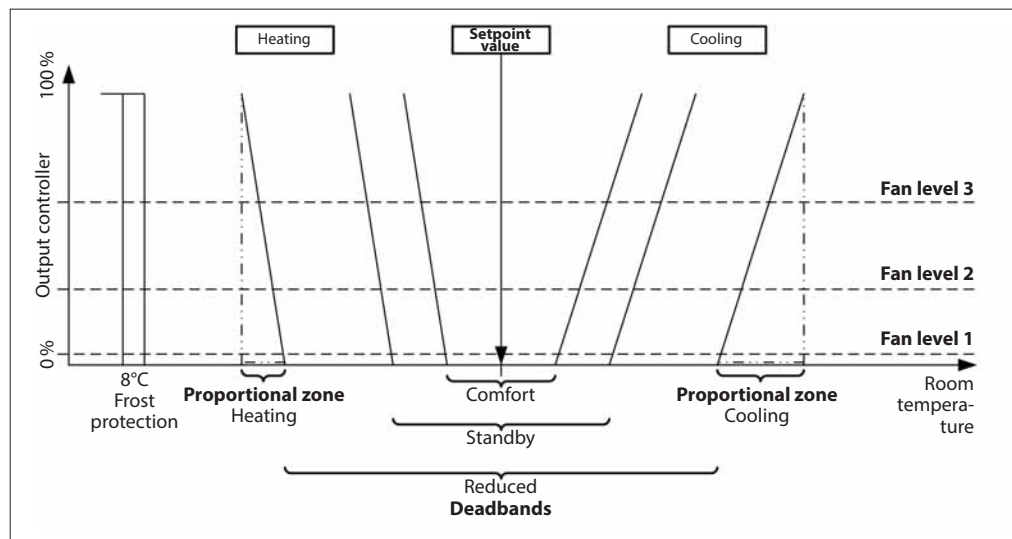

Example of a selection of PCD7.L60x-1 control parameters.

## Control devices and compact room controller installation information

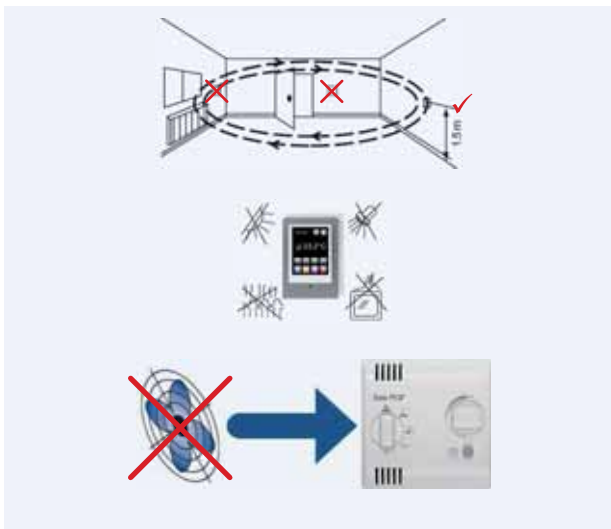

- ▶ Do not install the control device/compact room controller near windows or doors due to potential draughts. The recommended position is on an opposite wall at a height of approx. 1.5 m.
- ▶ Do not install it near to heat sources such as heating systems, fridges, lights, etc. Avoid direct sun light or direct light from strong lamps.
- ▶ Do not located the control device/compact room controller in the path of draughts from climate control or ventilation systems.

## Planning reserves

If the predefined application is insufficient, free outputs can be also be controlled for fully independent function directly via the Saia PCD® program using the S-Bus.

The room controller can also be configured as a single RIO unit (Remote Input Output) by completely switching off the fully independent function. The Saia PCD® station assumes control of all the inputs and outputs.

The resulting dependency of the availability of the S-Bus communication and the increase in the S-Bus cycle time should be taken into account during the planning stage.

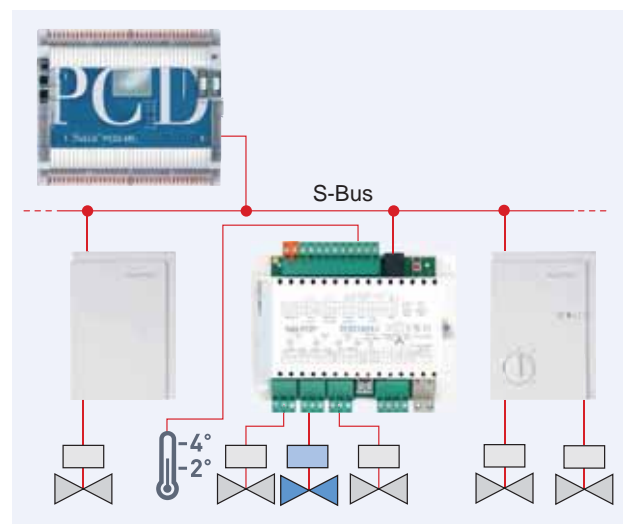

Control of free outputs via Saia PCD®

## 3.2 PCD7.L79xN compact room controller

The series of compact room controllers is particularly suitable for simple systems which involve heating and/or cooling.

The PCD7.L79xN series room controllers include the control of presence and setpoint values, the room temperature sensor and the valve or flap control in a single housing. The preconfigured regulation and control program is part of the basic software and can be parameterised via the network communication and adjusted to the individual requirements.



Parameterised via bus with S-Engineering tools

### Efficient installation

The compact room controller can be installed directly on a wall or in a flush-mounted box. A junction box is not required, which also simplifies the installation process.

Thanks to the plug-in housing (electronics) on the mounting plate with the terminals, it is easy to exchange the device without complex and fault-prone rewiring.

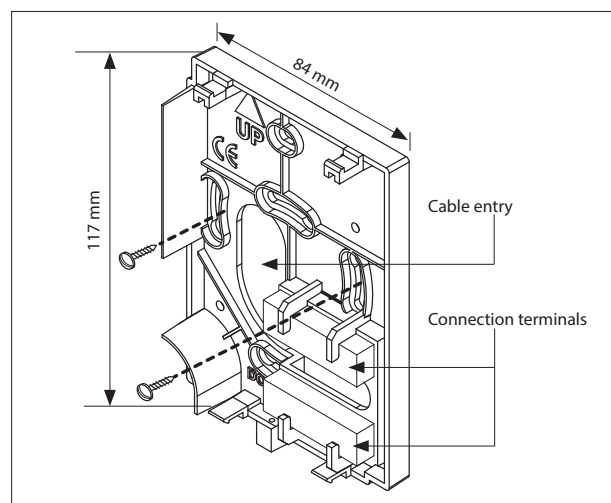



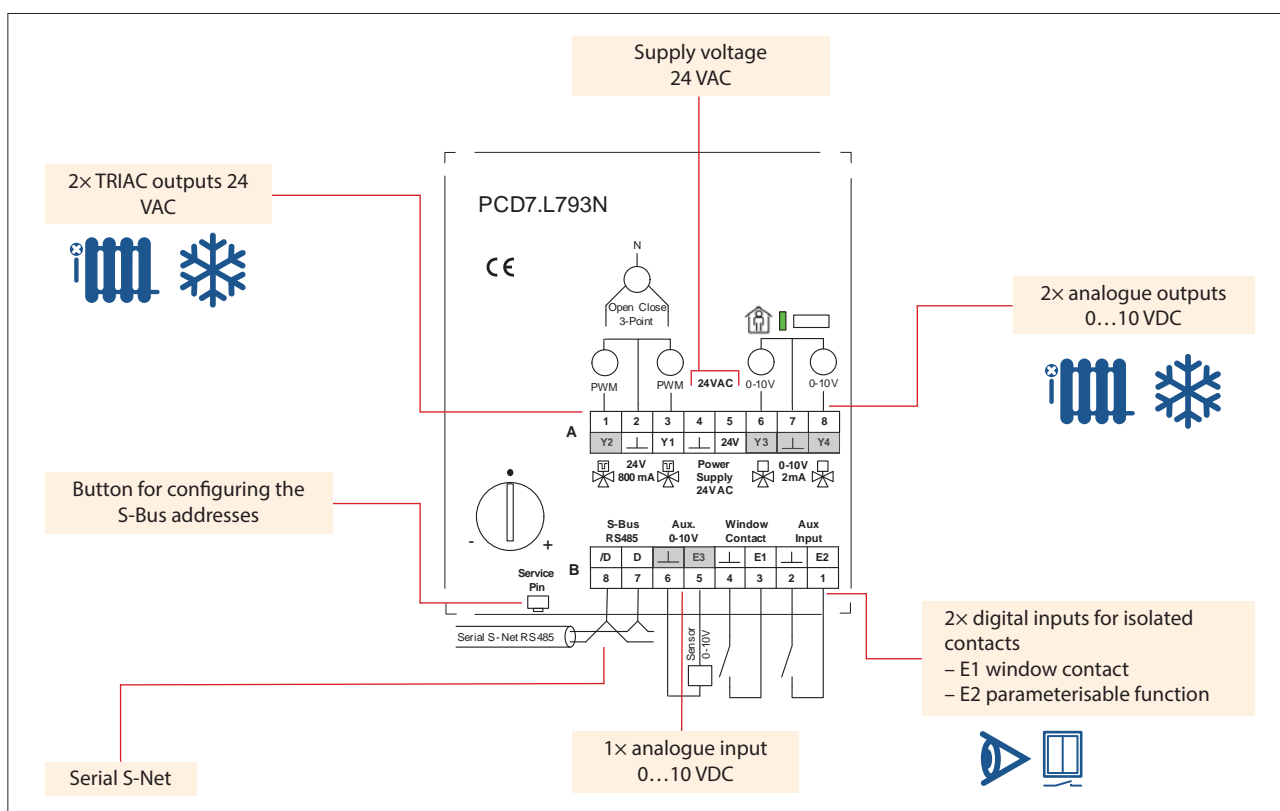

Mounting plate

### Terminal configuration (example of a PCD7.L793N)



## Product overview of the PCD7.L79xN series

	PCD7.L790N	PCD7.L791N	PCD7.L792N	PCD7.L793N
I/O				
Digital inputs	1× window contact and 1× multi-functional	1× window contact and 1× multi-functional	1× window contact and 1× multi-functional	1× window contact and 1× multi-functional
Digital outputs (PWM)	1 × Triac 24 VAC	2 × Triac 24 VAC	2 × Triac 24 VAC	2 × Triac 24 VAC
Analogue inputs	---	---	---	1 × 0...10 VDC
Analogue outputs	---	---	---	2 × 0...10 VDC

### Integrated hardware

Internal temperature sensor	NTC 10 kΩ	NTC 10 kΩ	NTC 10 kΩ	NTC 10 kΩ
Setpoint value setting	---	---	Yes	Yes
Presence button with LED	---	---	Yes	Yes

### Actuated valve types and drives (Count of independent)

Digital output 24 VAC	1 × thermal valve	2 × thermal valve or 1 × 3-point valve	2 × thermal valve or 1 × 3-point valve	2 × thermal valve or 1 × 3-point valve
Analogue output 0...10 VDC	---	---	---	2 × 0...10 VDC valves or 1 × 6-way valve or 1 × VAV controller

### Applications

2 pipes for heating, cooling or changeover	Yes	Yes	Yes	Yes
2 × 2 pipes for heating, cooling or changeover	---	Yes	Yes	Yes
4 pipes for heating and cooling	---	Yes	Yes	Yes
RIO	Yes	Yes	Yes	Yes

### Application examples:

Radiator/cooling ceiling, underfloor heating/cooling ceiling combination (or as individual units), changeover operation (e.g. for cooling/heating ceiling)

### General data

Supply voltage	24 VAC / requires an external electrical series fuse
Temperature detection internal sensor	NTC 10 kΩ / 0...40°C
Type of control	P or PI control
Communications interfaces	SBC S-Bus / RS-485 interface / data mode / 4800, 9600, 19200, 38400, 115200 bit/s with automatic detection on restart. Bus termination resistors are installed by the customer - integrated in the PCD7.L79xN and activated by the software.
Power consumption:	1.5 W without actuators
TRIAC output specification	24 VAC / 800 mA maximum total current for both TRIAC
TRIAC direction of operation	Invertible direction of operation / default settings: Normally open
Output specification 0...10 VDC	0...10 VDC / max. load 2 mA
Housing	Plastic, white, surface installation, protection class IP20
Dimensions	84 × 117 × 31 mm (W × H × D)
Temperature range	5...45 °C, 80% r.H.

### Manual and FBox library



Web code  
scen13103

### 3.3 Saia PCD7.L6xx combinable room control system with S-Bus and LONWORKS®

For multi-section room automation including air quality control and light/shade.

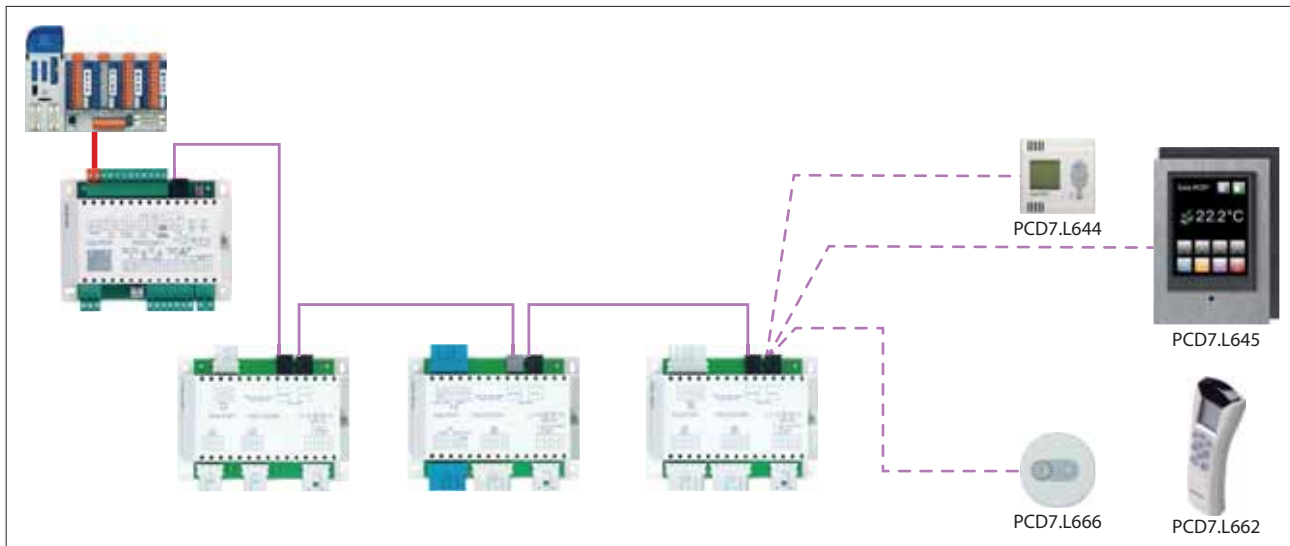

The PCD7.L6xx combinable room control system based on serial S-Net or LONWORKS® networks is used for HVAC applications primarily in fan coil devices, radiator/cooling ceiling combinations or variable air volume systems (VAV). The extension module for light and shade allows the electrical system to be conveniently integrated in the room automation solution. The various room control unit options make it possible to generate individual operating concepts.

#### Features

- ▶ Comprehensive range of applications possible using parameterisable application program
- ▶ Room controller for communication via serial S-Net or LONWORKS®
- ▶ Extension module for the electrical system
- ▶ Can be combined with various room control unit options
- ▶ The LON room controllers fulfil the "Fan Coil Unit Object (8020)" application profile of LONMARK®.

#### Control accuracy eu.bac certified

This "european building automation controls association" certificate certifies that the PCD7.L616 room controller saves more energy than required by the European standards. This certification has been issued for a 2- and 4-pipe fan coil application and certifies the controller has a temperature control accuracy (CA) of at least 0.2 K, which is a very accurate value compared to the room controllers of other manufacturers.

Certificate on eu.bac homepage











Webcode scen13104





## Product overview: S-Bus and LonWorks® room controller

System catalogue PCD7 product line	S-Bus				LonWorks				eu, bac Cert
									
<b>Supply voltage</b>	230 VAC +10%/–15%	230 VAC +10%/–15%	24 VAC +10%/–10%	230 VAC +10%/–15%	230 VAC +10%/–15%	230 VAC +10%/–15%	230 VAC +10%/–15%	230 VAC +10%/–15%	230 VAC +10%/–15%
<b>Inputs</b>	<b>L600-1</b>	<b>L601-1</b>	<b>L603-1</b>	<b>L604-1</b>	<b>L610</b>	<b>L611</b>	<b>L614*</b>	<b>L615*</b>	<b>L616*</b>
Digital inputs	1× window contact and 1× multi-functional	1× window contact and 1× multi-functional	1× window contact and 1× multi-functional	1× window contact and 1× multi-functional	4× multi-functional	1× window contact and 1× multi-functional	4× multi-functional	4× multi-functional	4× multi-functional
Operating state response	Yes	Yes	Yes	Yes	Yes	Yes	Yes	---	Yes
Analogue inputs 0...10 VDC	---	1× 0...10 VDC	1× 0...10 VDC	1× 0...10 VDC	---	---	1× 0...10 VDC	2× 0...10 VDC	1× 0...10 VDC
Temperature sensor	1× NTC 10 kOhm	1× NTC 10 kOhm	1× NTC 10 kOhm	1× NTC 10 kOhm	1× NTC 10 kOhm	1× NTC 10 kOhm	1× NTC 10 kOhm	2× NTC 10 kOhm	1× NTC 10 kOhm
Setpoint value adjuster (10 kOhm potentiometer)	Yes	Yes	Yes	Yes	Yes	Yes	Yes	---	Yes
<b>Outputs</b>	<b>L600-1</b>	<b>L601-1</b>	<b>L603-1</b>	<b>L604-1</b>	<b>L610</b>	<b>L611</b>	<b>L614*</b>	<b>L615*</b>	<b>L616*</b>
Digital outputs TRIAC	2× 230 VAC (total max. 800 mA)	2× 230 VAC (total max. 800 mA)	2× 24 VAC (total max. 800 mA)	2× 24 VAC <sup>1)</sup>	2× 230 VAC (total max. 800 mA)	2× 230 VAC (total max. 800 mA)	2× 24 VAC <sup>1)</sup>	4× 230 VAC (total 2× max. 800 mA)	2× 230 VAC (total max. 800 mA)
Relay outputs 3-level	1× 230 VAC (3 A)	1× 230 VAC (3 A)	1× 230 VAC (3 A)	1× 230 VAC (3 A)	1× 230 VAC (3 A)	1× 230 VAC (3 A)	1× 230 VAC (3 A)	---	1× 230 VAC (3 A)
Relay outputs 1-level	1× 230 VAC (10 A)	1× 230 VAC (10 A)	1× 230 VAC (10 A)	1× 230 VAC (10 A)	1× 230 VAC (10 A)	1× 230 VAC (10 A)	1× 230 VAC (10 A)	2× 230 VAC (10 A)	1× 230 VAC (10 A)
Analogue outputs (total max. 2 mA)	---	2× 0...10 VDC	2× 0...10 VDC	2× 0...10 VDC	---	2× 0...10 VDC	2× 0...10 VDC	2× 0...10 VDC	2× 0...10 VDC
Analogue outputs with additional 24 VAC power supply	---	---	Yes	Yes <sup>1)</sup>	---	---	Yes <sup>1)</sup>	---	---
<b>Extension modules</b>	<b>L600-1</b>	<b>L601-1</b>	<b>L603-1</b>	<b>L604-1</b>	<b>L610</b>	<b>L611</b>	<b>L614*</b>	<b>L615*</b>	<b>L616*</b>
Light modules	Yes	Yes	Yes	Yes	---	Yes <sup>4)</sup>	---	Yes <sup>2)</sup>	---
Shade modules	Yes	Yes	Yes	Yes	---	Yes <sup>3)</sup>	---	---	---
<b>Possible applications</b>	<b>L600-1</b>	<b>L601-1</b>	<b>L603-1</b>	<b>L604-1</b>	<b>L610</b>	<b>L611</b>	<b>L614*</b>	<b>L615*</b>	<b>L616*</b>
Electrical heating only	Yes	Yes	Yes	Yes	Yes	Yes	Yes	Yes	Yes
2 pipes for heating or «Change over»	Yes	Yes	Yes	Yes	Yes	Yes	Yes	Yes	Yes
2 pipes for cooling or «Change over» with electrical heating	Yes	Yes	Yes	Yes	Yes	Yes	Yes	Yes	Yes
4 pipes for heating and cooling	Yes	Yes	Yes	Yes	Yes	Yes	Yes	Yes	Yes
4 pipes for heating and cooling and electrical heating (secondary)	Yes	Yes	Yes	Yes	Yes	Yes	Yes	Yes	Yes
4 pipes for heating and cooling and electrical heating (primary)	---	---	---	---	Yes	Yes	Yes	Yes	Yes
2 × 2 pipes for heating, cooling or changeover	Yes	Yes	Yes	Yes	---	---	---	---	---
RIO	Yes	Yes	Yes	Yes	---	---	---	---	---
Direct control of outputs	---	---	---	---	Yes	---	Yes	---	Yes
<b>Special functions</b>	<b>L600-1</b>	<b>L601-1</b>	<b>L603-1</b>	<b>L604-1</b>	<b>L610</b>	<b>L611</b>	<b>L614*</b>	<b>L615*</b>	<b>L616*</b>
Air quality control (CO <sub>2</sub> )	Yes	Yes	Yes	Yes	---	---	Yes	---	Yes
Master / Slave	Yes	Yes	Yes	Yes	---	---	---	---	---

### Controlled valves and required I/O

- Thermal valve:** 1 digital output (Triac PWM)  
**0...10 V valve:** 1 analogue output (0...10 VDC)  
**3-point valve:** 2 digital outputs (Triac PWM)  
**6-way valve:** 1 analogue output (0...10 VDC) → can only be connected to one 6-way valve

### Controlled motors and required I/O

- VAV controller:** 1 analogue output (0...10 VDC)  
**3-level fan:** 1 relay output 3-level  
**Fan with variable rpm:** 1 analogue output (0...10 VDC) → with PCD7.L601-1...L604-1 and PCD7.L614...L616 devices only  
**Electric heating:** 1 relay output 1-level

**Application examples:** Fan coil, chilled beam, air quality control (combined with heating and second level cooling (radiator/cooling ceiling-, underfloor heating/cooling ceiling combination, changeover operation (e.g. for cooling/heating ceiling), VAV

<sup>1)</sup> PCD7.L6x4-1: The total power consumption of valves must be max. 7 W. Output voltage : 24 VAC; -15%/+35 %

<sup>2)</sup> Without automatic function

<sup>3)</sup> Without blind slats rotation

<sup>4)</sup> Without dimming

\*In preparation, see chapter C2 «Product status»

## Terminal configuration (example of a PCD7.L601-1)

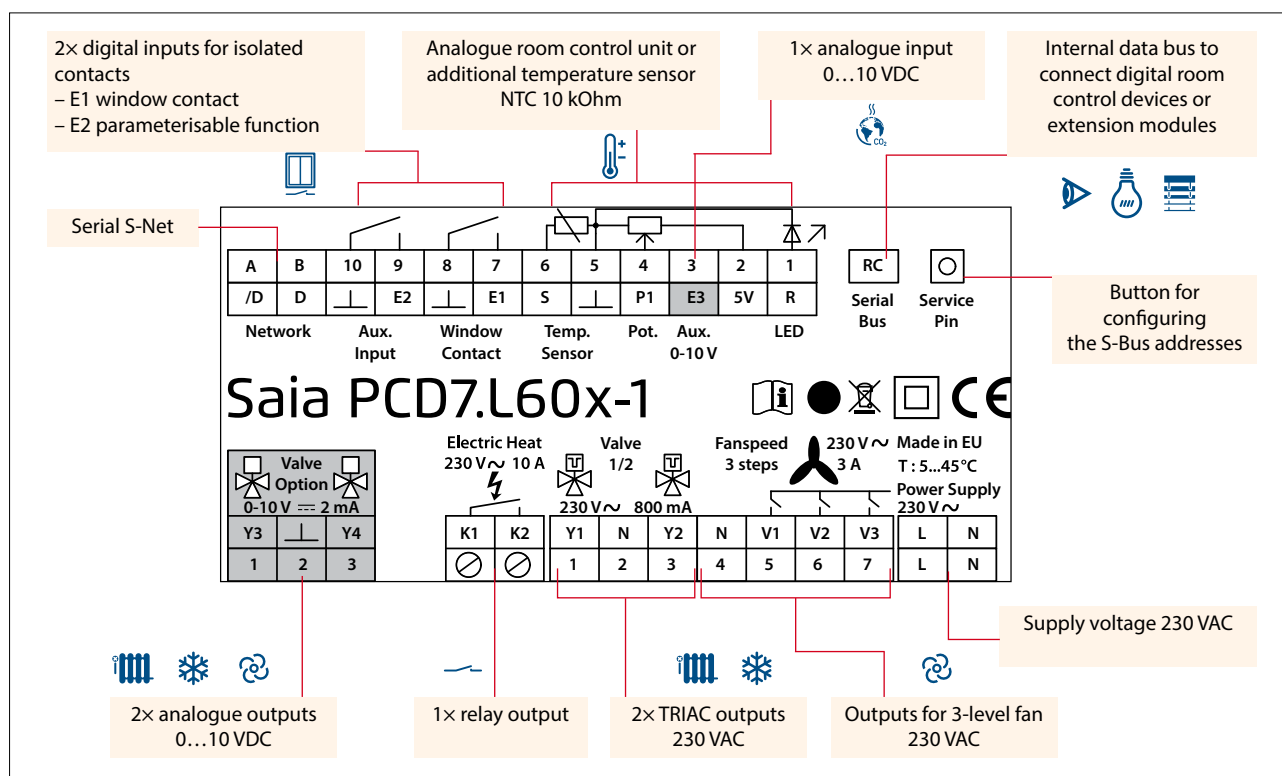

## Technical data

TRIAC output specification	10 mA...800 mA, maximum total current of both TRIAC
Current consumption	Without actuator approx. 100 mA / requires an external electrical series fuse
Protection	The module has to be installed in a locked box with aerations – minimum size: 240 x 145 x 100mm
Dimensions W x H x D	132 x 95 x 45 mm
Temperature range	5...45°C, 80% r.H.

## Communication with S-Bus

Interface	RS-485, max. cable length of bus cable depends on baud rate, under ideal conditions up to max. 1200 m
Transmission rate	4800, 9600, 19200, 38400, 115200 bit/s with automatic detection on restart
Log	SBC S-Bus data mode (slave) Bus termination resistors have to be installed by the customer - in case of the L60x-1 the are integrated and can be activated by software.

## Communication with LonWorks®

Interface	FTT 10a
Transmission rate	78 kBit/s
Topology	Free topology max. 500 m, bus topology max. 2700 m
Number of Lon nodes	max. 64 per segment, over 32000 in a domain / as per LONMARK® 8020 profile

## Dimensions for:

- ▶ PCD7.L60x
- ▶ PCD7.L61x
- ▶ PCD7.L62x

## Installation:

- ▶ On 35 mm DIN hat rail
- ▶ Or with min. 2 x  $\varnothing$  3 mm screws on an even surface

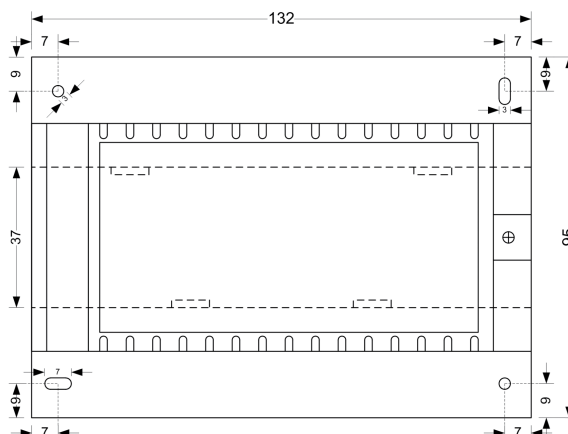

Manuals and  
FBox library  
Webcode scen13106



## Light and shade modules for extending room controllers

In conjunction with a PCD7.L60x-1 room controller, it is possible to control on/off lights, dimming lights and blinds via PCD7.L62xN extension modules. FBoxes enable, among other things, a reconfiguration of the dimming ramp or of the rotation time for window blind slats. Control instructions may be executed either manually from a room control unit or automatically via the PCD7.L665/6 presence sensor or via S-Bus from the PG5 program. This makes it possible to save energy across plant systems.

Where there are several extension modules of the same type, for each room controller the same outputs can be controlled in similar groups.

	PCD7.L620N*	PCD7.L621N*	PCD7.L622N*	PCD7.L624N*	PCD7.L650
On/Off light outputs, 1 relay 230 VAC/2 A per output <sup>1)</sup>	3x: L1, L2, L3				---
Dimming light outputs, 1 relay 230 VAC/2 A <sup>1)</sup> and output 1...10 V max. 3 mA		2x: L3, L4		3x: L1, L2, L3	
Motor outputs, 2 relays 230 VAC/2 A per output <sup>2)</sup>		1x: S4	3x: S1, S2, S3		---
Supply voltage	230 VAC				Via RC-Bus
Max. current consumption via supply terminal	6 A				---
Isolated contact inputs	---	---	---	---	8
RC-Bus-Anschaltung	•	•	•	•	•
Protection degree	IP 20				
Dimensions	132 × 95 × 45 mm				
Temperature range	5...45 °C, 80 % r.H.				

1) Start current < 60 A for < 2 ms.

2) Peak current < 4 A for < 20 ms

Supplied without connector. Information regarding Wieland item numbers is available from [www.sbc-support.com](http://www.sbc-support.com).

### Light and shade in groups

The light and shade extension modules are controlled using group commands. Four <sup>3)</sup> independent groups for light and shade are available per controller. Each output can be assigned to one or more groups. The light groups can be switched on/off together or separately. The shade groups can also operate independently of one another to control the blinds.

<sup>3)</sup> with PCD7.L644, PCD7.L660 and PCD7.L662 / with PCD7.L650 only two controllable groups

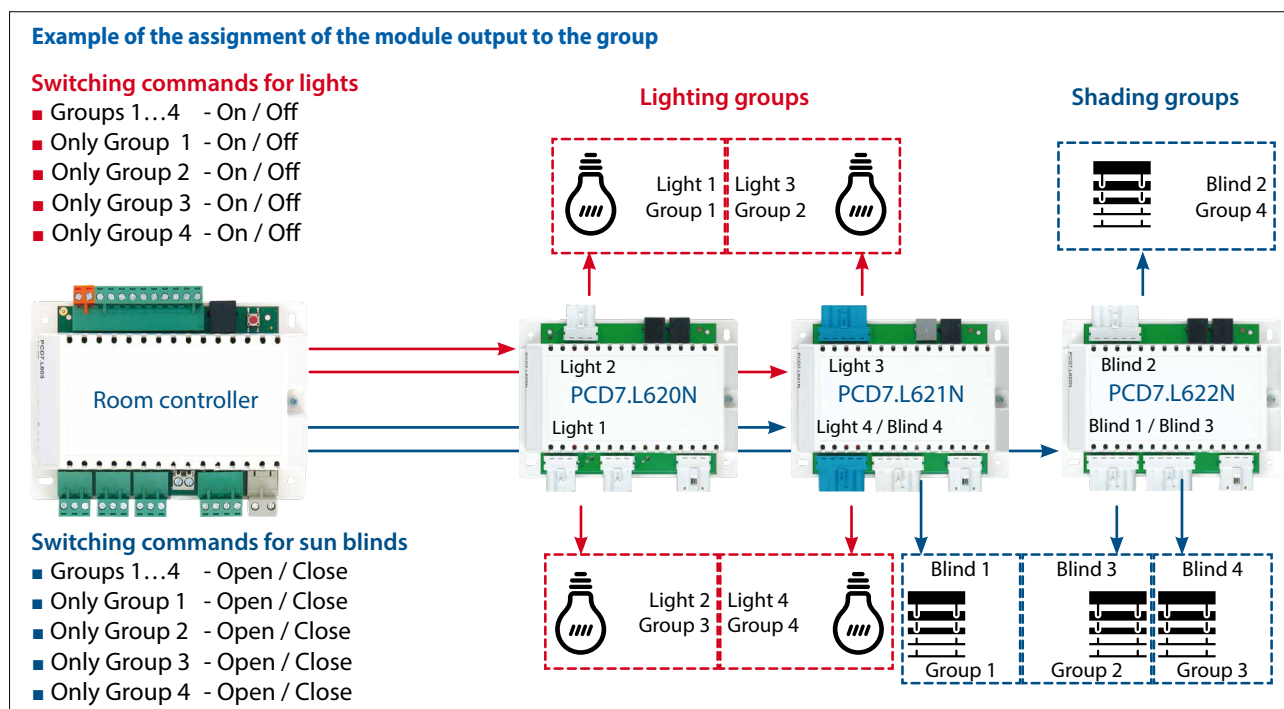

### Lighting information:

When the PCD7.L621N expansion module works in combination with the PCD7.L620N or PCD7.L624N expansion module on a single controller, the L3 output can only be switched within the same group. The same behaviour also applies at outputs L1, L2 and L3 when PCD7.L620N and PCD7.L624N expansion modules operate on a single controller.



### Accessories





PCD7.L672	Room controller connection cable / extension module RJ-11 / RJ 9, 0.3 m
PCD7.L672-10	Room controller connection cable / extension module RJ-11 / RJ 9, 10 m
PCD7.L672-50	Room controller connection cable / extension module RJ-11 / RJ 9, 50 m

## 3.4 Operation systems for combinable room control system PCD7.L6xx

Individual operating concepts can be implemented using the combination room control system:

- ▶ Single connection via the internal RC-Bus to the RJ-9 connector
- ▶ LonWORKS® room control unit of external manufacturers via Lon-Bus
- ▶ Web-based room control unit via HTTP

	PCD7. L630	PCD7. L631	PCD7. L632
<b>Analogue room control unit</b>			
Temperature sensor	NTC 10 kΩ		
Setpoint value adjuster	---	Poti 10 kΩ   linear	
Presence button	---	---	Contact to ground
Response	---	---	LED

	PCD7. L640	PCD7. L641	PCD7. L642	PCD7. L644
<b>Digital room control units</b>				
Temperature sensor	•	•	•	•
Setpoint value adjuster	•	•	•	•
Presence button	---	•	•	•
Response	---	•	•	•
Fan control	---	---	•	•
Display menu for: HVAC functions	---	---	---	Parametrisable
Light and shade	---	---	---	Parametrisable

### Dimensions and installation options:

PCD7.L63x, PCD7.L64x, PCD7.L651, PCD7.L663

Housing colour: RAL 9016

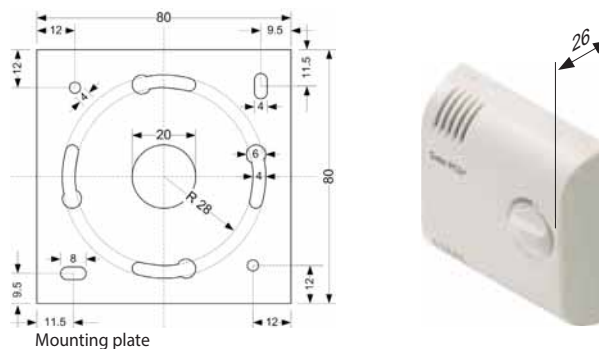

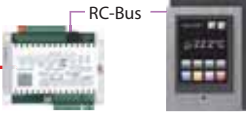
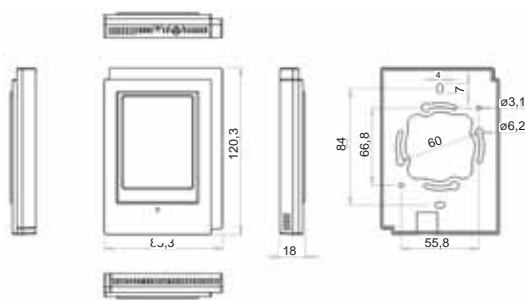
	PCD7.L645W/B*	Dimensions and installation options
<b>3.2" touchscreen room control unit PCD7.L645W/B</b>		
Control for: setpoint value, fan, light, shade and presence	max. 10 m cable length	
If, for example, a function is no longer to be displayed, access to specific menus can be prohibited with a password and hidden.		

- ▶ Automatic adjustment of the dimmable backlight depending on the actual brightness in the room ensures optimum reading comfort
- ▶ Screen standby timer for setting the time after which the screen will dim following the last action
- ▶ Scenario buttons for defining user settings and opening them as required with a keystroke (up to 4 pre-defined scenarios can be saved)

PCD7.L645W: white housing (Pantone Q 716-3-5),  
1 white and 1 aluminium front panel  
PCD7.L645B: black housing (RAL 9011),  
1 black and 1 aluminium front panel

Some projects require an individual design in terms of shape and colour. The PCD7.L645W/B offers the option of replacing the front panel. The scale drawing for production on page 8-1 of manual 27-605 is provided for manufacturing individual front panels.



\*Under development, see chapter C2 "Product status"

Portable room control units with display and function keys

Control devices	PCD7. L660	PCD7. L662		
Receivers	PCD7. L661	PCD7. L663	PCD7. L665*	PCD7. L666*
 max. 50 m cable length				
Wall mounted control device	Including for fixed installation		---	---
Communication / IR (infrared)	Unidirectional		•	---
Communication / radio			---	•
Temperature sensor	•	•	---	---
Setpoint value adjustment	•	•	•	•
Presence control	•	•	Motion sensor	
Fan control	•	•	•	•
Light and shade	•	•	•	•
Brightness sensor	---		•	•
Supply voltage control device	2 x AAA 1.5 V Micro		---	---
Temperature range	+5...45 °C, 80 % r.H.			

PCD7.L662-CT\* Configuration tool to connect PCD7.L666 to PCD7.L662

EnOcean radio receiver PCD7.L651\* for connecting Thermokon room control devices and EnOcean wireless switches

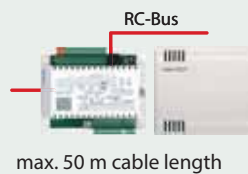

Example of EnOcean wireless switch for controlling lights and Venetian blinds (compatible with various control programs of various manufacturers)



Example of EnOcean room control devices for controlling HVAC



More detailed information on the compatibility of the EnOcean receivers is contained in the PCD7.L651 manual

Communicative room control units

Individual solutions using web-based room control units

System requirements:

- ▶ Room controller with communication to PCD via S-Net, LonWORKS®.
- ▶ PCD with corresponding interface and interface for connecting to the desired control device, e.g. webpanel, PC, iPhone, etc.

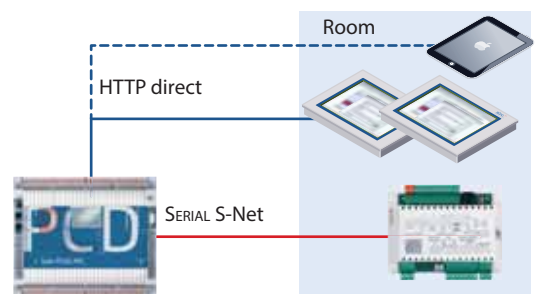
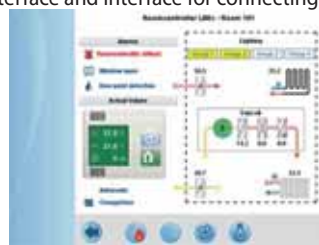

Direct connection of the room control units from the external supplier via LonWORKS®

System requirements:

- ▶ Room controller with LonWORKS® interface.
- ▶ For making additional connections to the automation station, the – PCD3.M– PCD2.M5– PCD1.M2 can be connected via the Lon over IP or via an external FT10/IP router.

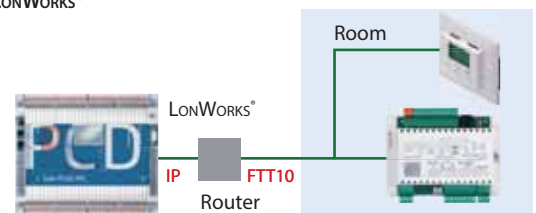

\*Under development, see chapter C2 "Product status"



## Example of system structure for touch panel and extension module

- ▶ Room controller: Basic types PCD7.L600-1, PCD7.L601-1, PCD7.L603-1, PCD7.L604-1 and PCD7.L611
- ▶ The room control units and extension modules are connected to the room controller as required (The extension modules can only be operated in connection with a room controller)
- ▶ A maximum of 4 groups each of light and shade functions can be configured

### 3 different options for controlling extension modules:

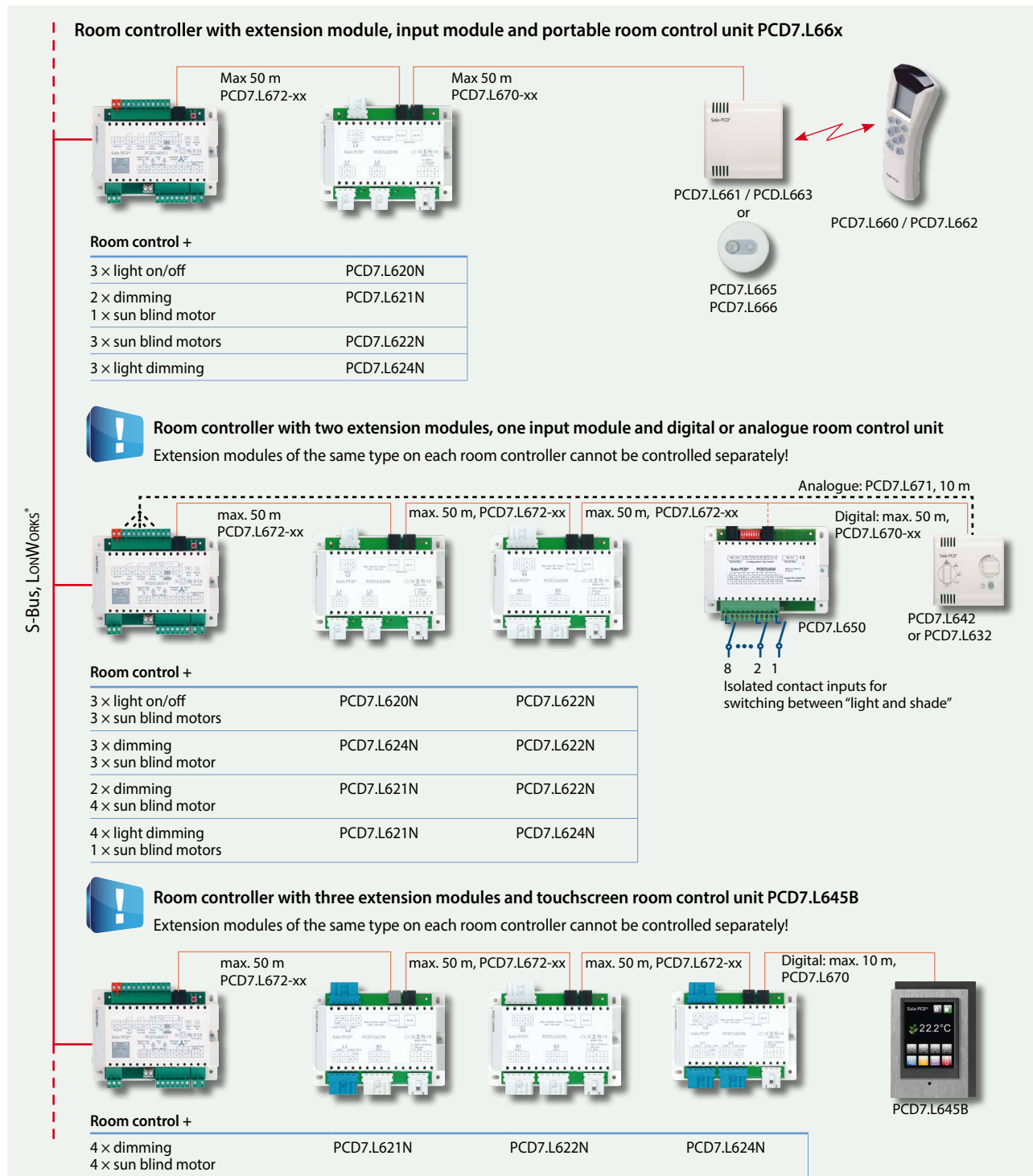

### Accessories

PCD7.L670	Connection cable for digital room control units RJ9 / RJ9, 10 m
PCD7.L670-30	Connection cable for digital room control units RJ9 / RJ9, 30 m
PCD7.L670-50	Connection cable for digital room control units RJ9 / RJ9, 50 m
PCD7.L671	Connection cable for analogue room control units RJ11 / open cable strand, 10 m
PCD7.L673	Connecting cable set for digital room control units, 3x RJ9 and 1 x RJ11, length 11 m



## High energy efficient room automation

The combinable room control system can be used for multi-section room automation whereby with the demand-based control and communication to the primary system can reach the highest energy efficiency classes of DIN EN 15232 for the entire building automation system.

### Energy efficiency of building energy efficiency classes in accordance with EN 15232

#### Class A:

– High energy efficiency room automation and cross linked trades (application segment)

#### Class B:

– Optimised solutions for each trade, partially cross linked

#### Class C:

– Standard room automation

#### Class D:

– No room automation, not energy efficient

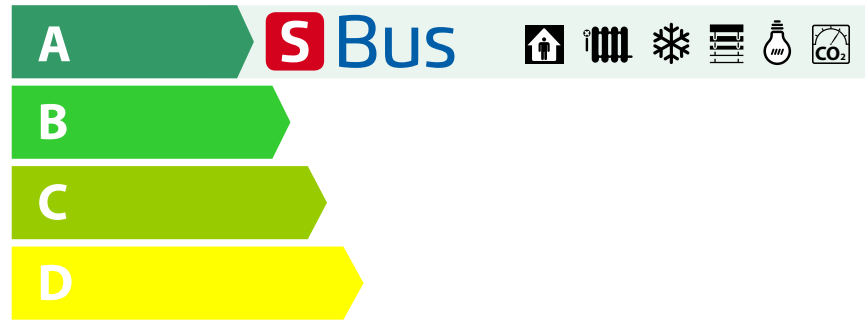

- ▶ Networked room automation for an optimum synergy between the sections
- ▶ Temperature control based on demand control
- ▶ Combined air quality and temperature control

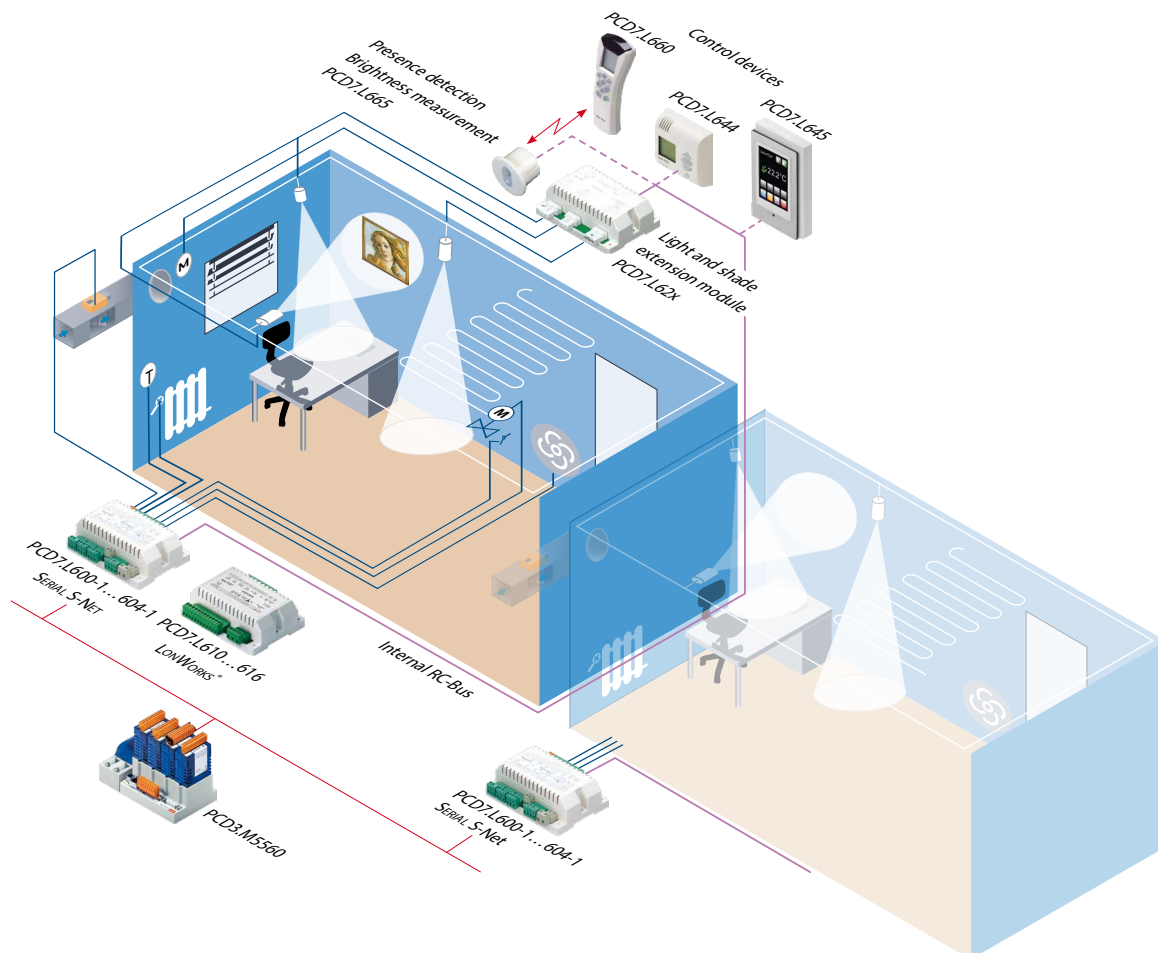

1 Automation stations

2 HMI Visualization and operating

3 Dedicated room controller

4 Consumption data acquisition

5 Cabinet components



# A4

## Capturing, visualising and processing consumption data

With the field devices of the S-Monitoring system, electrical energy is measured and signals from water, gas and heating meters are captured. The data is automatically further processed and visualised clearly by the S-Monitoring application. Thus, the system generates a high degree of transparency with regard to resource consumption. This works from just a few measuring points up to thousands of measuring points in distributed properties.



**S** Monitoring

### 4.1 System overview

Page 114

S-Monitoring makes energy and consumption management easy. Ready-to-use direct from the packaging, it can be used without complicated configuration and programming. Yet it can subsequently be customized to meet to special requirements – it is a system that grows with you.



### 4.2 Saia PCD® S0 pulse counter

Page 116

Collect, convert and transmit S0 pulses: With the PCD7.H104 pulse counter modules, non bus-capable meters can also be integrated in an S-Monitoring system.



### 4.3 Saia PCD® S0 pulse counter with temperature inputs

Page 117

With the PCD7.H108S, not only S0 pulses, but also up to four temperature measurement points can be integrated in one Saia PCD® automation system.



### 4.4 Saia PCD® energy meters

Page 118

Saia Burgess Controls, or SBC for short, is a European market leader in bus-capable energy meters for secondary measurement of electrical energy data: for machines, plants and building components.



### 4.5 Basic functions of the S-Monitoring application

Page 126

S-Monitoring is an integral part of the COSinus operating system and is integrated in all new Saia PCD® controllers. It makes it possible to capture consumption data automatically without time-consuming programming and saves it on the file system.



### 4.6 Saia PCD® E-Monitor

Page 128

The E-Monitor combines data capture, visualisation and logging in one compact control panel. This makes it easy to start data capture.



### 4.7 Saia PCD® E-Controller

Page 130

The E-Controller with S-Monitoring function combines data capture, visualisation and logging of energy consumption in one compact device. Via the inputs and outputs, it is possible to intervene in processes for regulation.



1 Automation stations

2 HMI Visualization and operating

3 Dedicated room controller

4 Consumption data acquisition

5 Cabinet components

# 4.1 System overview

S-Monitoring makes energy and consumption management easy. Ready-to-use direct from the packaging, it can be used without complicated configuration and programming. Yet it can subsequently be customized to meet special requirements – it is a system that grows with you.

The system includes devices and components for capturing, recording and displaying consumption. With the Web Panel installed on-site, analysis can be carried out conveniently at the office PC or remotely via the Internet web browser. The open IT interfaces make it possible to connect the system to a superordinate data management system at any time. The hardware does not need to be replaced to do this.



**Continuous optimization in calculable steps:**

Sustainable resource management means a continuous gain in knowledge in a changing environment. The optimum solution is different for each business, and must be developed with careful consideration. S-Monitoring supports a cautious approach in small, controllable steps and starts with the basics. By means of cost-effective, easy-to-install components, it is possible to start resource management without external help. Even after just a few days, initial results are set and point the way for further optimization steps. The investment risk is negligible and remains limited to each individual development step.

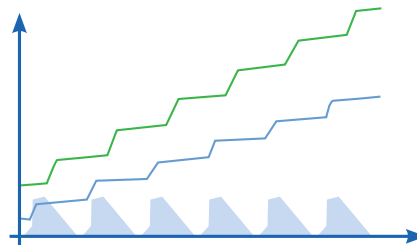

With step-by-step introduction, findings from the learning curve are incorporated and lead to optimum results

Automation stations

1

**Visualising consumption and evaluating it remotely**

- **Reading and operating via LAN/Internet with web browser and mobile devices**
- **Integration in other systems via standard interfaces**

If the Web Panel and controller are connected to a network (LAN), meter readings and operation can be carried out using commercially available PCs with standard browsers. Special software installations are not required, and apps are available for mobile devices. This can even be carried out across locations if there is an Internet connection.

Databases, energy management software or control systems can be connected via standard interfaces (e.g. FTP, CGI, HTTP, etc.).

HMI Visualization and operating

2

**Logging consumption**

- **Historic consumption recording (day/week/month/year)**
- **Logging in Excel-readable files**

The Web Panel and controllers read consumption values of the connected meters and display them in the form of a web visualisation. This can be called up either directly on the Web Panel or via the controller's web server with a web browser. Consumption and costs can be called up in meaningful diagrams via an intuitive user interface. In addition, the Web Panel and controllers record captured values in Excel-readable CSV files, which can be easily transferred to a PC via FTP. The function can be activated on any newer controller. The E-Controller and E-Monitor are already pre-installed in the factory and are ready for use without further programming.

Dedicated room controller

3

**Capturing consumption**

- **Wide range of single and three-phase energy meters up to 6,000 A**
- **S0 interface for integration of commercially available meters for gas, water, oil, etc.**

Saia PCD® energy meters follow established installation technology and are suitable for DIN rails of commercially available distribution boxes. The electrical work is recorded (electricity meters) along with the electrical values such as current, voltage, active power and reactive power, as well as the power factor  $\cos\phi$ . Integrated into a bus system covering a distance of up to 1 km, the values are transmitted to the Web Panel and controllers for the purpose of analysis and logging.

Via pulse meters with an interface, commercial available meters with S0 output or PT 1000 temperature sensors can be connected to the bus system.

Consumption data acquisition

4

Cabinet components

5

## 4.2 Saia PCD® S0 pulse meters

### Collecting, converting and transmitting S0 pulses

If already installed meters, which are not bus-capable, are to be integrated in an automation system, the Saia PCD7.H104 S0 pulse meter is the easiest way. This is the case for refurbishments, for example, if the existing meter infrastructure has to be made bus-capable and new meters are not simply purchased. With this S0 pulse meter, meters (electricity, water, heat, etc.) with a S0 pulse output from any desired manufacturer can be connected directly to the Saia PCD®, E-Monitor or any desired controller via a serial RS-485 S-Bus or Modbus connection. This enables efficient transfer, evaluation and forwarding of energy data without additional complicated coupler modules. For connection to Saia PCD® systems, there are ready-made FBoxes. Via the interfaces, the number or weights of pulses can be transmitted.

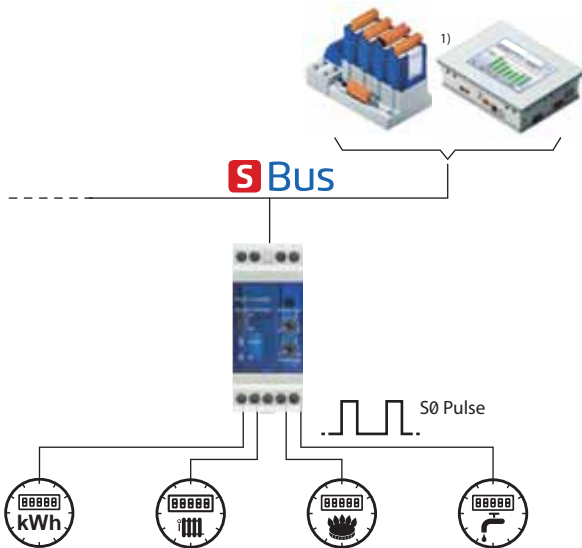

<sup>1)</sup> More information on the E-Monitor can be found in section 4.7 "E-Monitor"

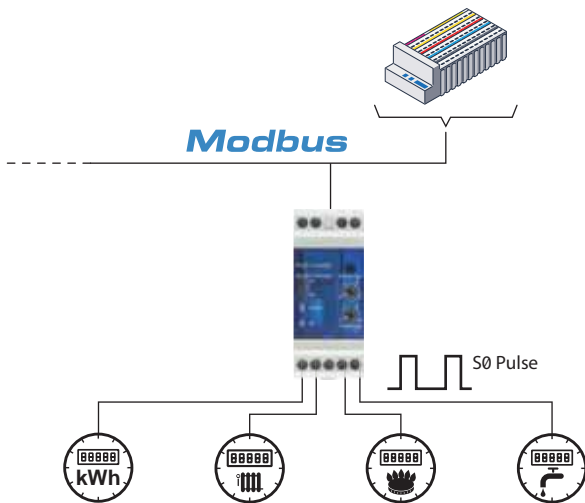

#### FBoxes for integration in FUPLA

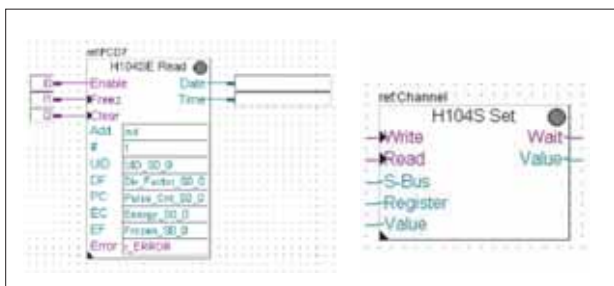

#### General technical data

Operating voltage	230 VAC (-20/+15 %)
Current draw	< 12 mA
Power consumption	< 3 W
Number of S0 inputs	4, corresponds to S0 standard 62053-31
Frequency	Max. 17 Hz
Pulse low/high	Min. 30 ms

#### S-Bus version

Order number	PCD7.H104SE
Log	S-Bus data mode
Bus system	Serial RS-485 interface
Transmission rate	2400, 4800, 9600, 19,200, 38,400, 57,600, 115,200 The transmission rate is detected automatically
Bus length (max.)	1,200 m (without amplifier)
Response time	Write: 30 ms
System response time	Read: 20 ms

#### Modbus version

Order number	PCD7.H104D
Log	Modbus RTU as per IDA specification
Bus system	Serial RS-485 interface
Transmission rate (bit/s)	2400, 4800, 9600, 19,200, 38,400, 57,600, 115,200 The transmission rate is detected automatically
Bit settings	8 databit, even parity, 1 stop bit 8 databit, odd parity, 1 stop bit 8 databit, no parity, 2 stop bit
Maximum bus length	1,200 m (without amplifier)
Response time	Type 5 characters
System response time	Max. 60 ms

#### Size

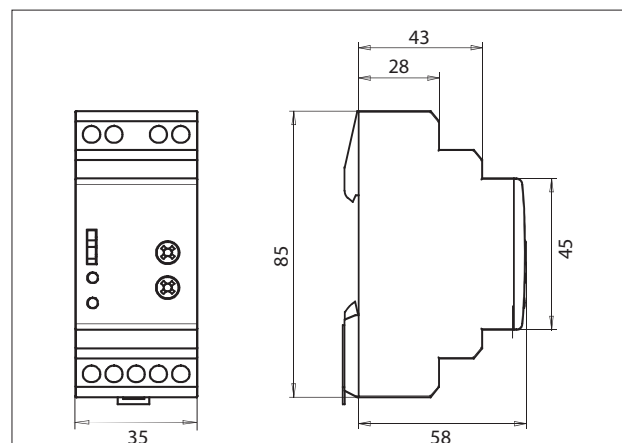



## 4.3 Saia PCD® S0 pulse meters with temperature inputs

### Reading and transmitting S0 pulse, temperature and S0+ data

The PCD7.H108S S0 pulse meters can, in addition to the classic S0 pulses, also capture temperatures and read and evaluate the SBC's own log sent uni-directionally via the S0 output.

The S0 pulses can be read by any desired measuring device. This is the case for refurbishments, for example, if the existing meter infrastructure has to be made bus-capable and there is no intention to purchase new meters.

The inputs of the S0 pulse meter can be connected directly to the PT1000 temperature sensors, in order to monitor the temperature in a switch cabinet, for example.

The PCD7.H108S module can capture the SBC-internal S0+ interface (transmission of measurement data via the S0 output) and makes the measurement data available via S-Bus.

The S0 pulse meter PCD7.H108S enables the efficient transfer, evaluation and forwarding of energy data without additional complicated coupler modules, direct to the S-Monitoring solutions of SBC. For connection to Saia PCD® systems, there are ready-made FBoxes. Via the interfaces, the number or valency of pulses can be transmitted.

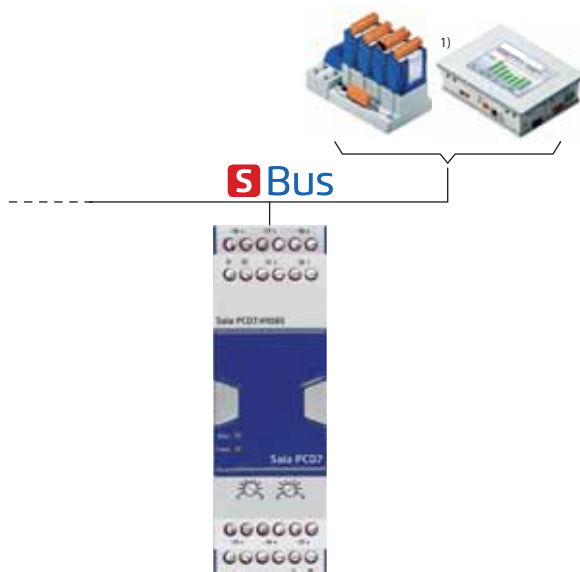

#### 4 inputs for:

- ▶ Counting of S0 pulses
- ▶ Unidirectional log transmission (S0+)

#### 4 multifunctional inputs for:

- ▶ Counting of S0 pulses
- ▶ Unidirectional log transmission (S0+)
- ▶ PT1000 temperature sensors

<sup>1)</sup> S-Monitoring in preparation

#### FBoxes for integration in FUPLA

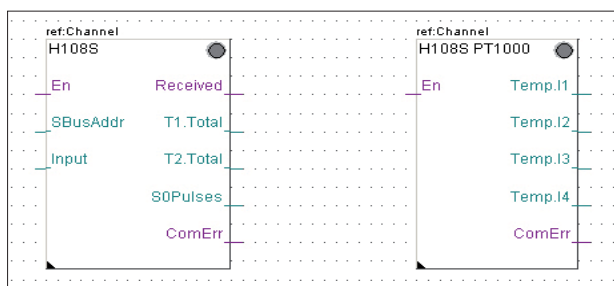

#### General technical data

Operating voltage	230VAC (-20% / +15 %)
Current draw	< 17 mA
Power consumption	< 4 W
Operating temperature	-25 °C...+55 °C
Detection of inputs	Automatic
Order number	PCD7.H108S

#### S0 inputs and unidirectional log (S0+)

Inputs	I1 – I8 as per standard IEC62053-31
Frequency	Max. 17 Hz
Pulse low/high	Min. 30 ms
Voltage	Max. 13 V
Current	Max. 6 mA

#### PT1000 inputs

Inputs	I1 / I4
Temperature range	-30...100° C
Accuracy	0.5° C

#### S-Bus interface

Log	S-Bus data mode
Bus system	Serial RS-485 interface
Transmission rates	2,400, 4,800, 9,600, 19,200, 38,400, 57,600, 115,200 The transmission rate is detected automatically
Bus length (max.)	1,200 m (without amplifier)
Response time	Read: 30 ms Write: 60 ms

#### Size

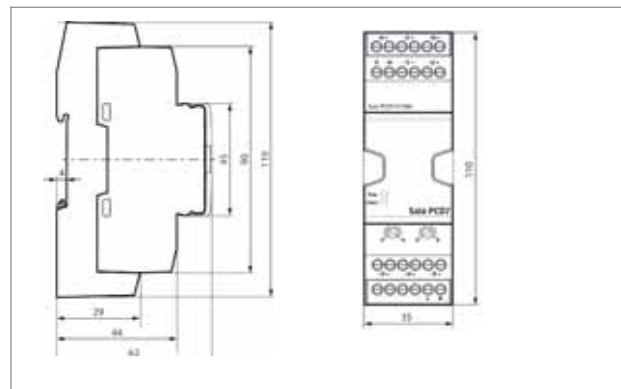

## 4.4 Saia PCD® energy meters

small, robust, reliable and accurate

Due to the very compact design, the energy meters are well suited to accommodating a large number of measuring devices in the smallest of spaces. The small size means the meters can also be fitted in existing switch cabinets without having to install new switch cabinets. The robust design has certainly proven itself under tough industrial conditions. The design of the energy meters is specifically designed for such applications, as is shown by a high level of reliability and durability. Production at the Swiss site in Murten means the high quality of the energy meters is guaranteed. The display shows energy, current, voltage and active output.



A large number of energy meters in the smallest of spaces ►

### Single-phase Saia PCD® energy meters

Interface	Single phase			
	Direct measurement 0.25...32 A		Converter connection up to 500:5 A	
	Unidirectional	Bidirectional	Unidirectional	Bidirectional
<b>M-Bus</b>	ALD1D5FM00A2A00	-	-	-
<b>Modbus</b>	ALD1D5FD00A2A00	-	-	-
<b>S-Bus</b>	ALD1D5FS00A2A00	ALD1B5FS00A2A00	AWD1D5WS00A2A00	-
<b>S0 interface</b>	ALD1D5F10KA2A00	ALD1B5F10KA2A00	-	-

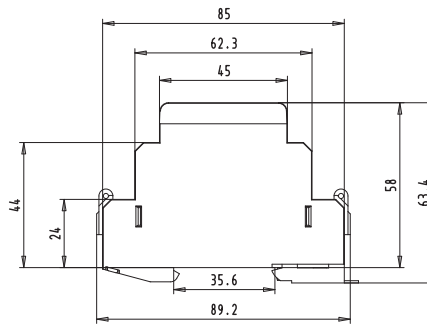
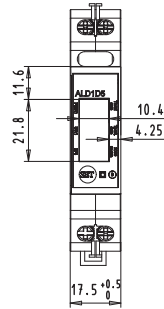
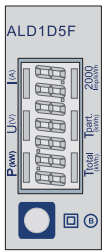

### Three-phase Saia PCD® energy meters

Interface	Three phase				
	Direct measurement 0.5...65 A		Converter connection up to 1500:5 A		up to 300:1 A
	Unidirectional	Bidirectional	Unidirectional	Bidirectional	Unidirectional
<b>M-Bus</b>	ALE3D5FM10C2A00	-	AWD3D5WM00C2A00	-	-
<b>Modbus</b>	ALE3D5FD10C2A00	-	AWD3D5WD00C2A00	-	-
<b>S-Bus</b>	ALE3D5FS10C2A00	ALE3B5FS00C2A00	AWD3D5WS00C2A00	AWD3B5WS00C2A00	AWC3D5WS00C2A00
<b>S0 interface</b>	ALE3D5F10KA2A00	ALE3B5F10KC2A00	AWD3D5W10MC2A00	AWD3B5W10MC2A00	-

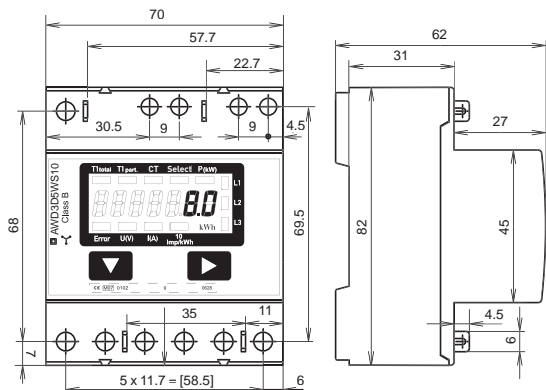
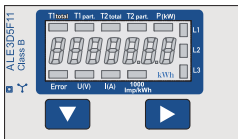

## 4.4.1 General information on Saia PCD® energy meters

### Reliability directly after delivery from the factory

The design and production of energy meters in Murten are such that the meters also exhibit high levels of reliability and durability even under extreme industrial conditions. The high quality standards of the Swiss production site guarantee high accuracy and enable the production of MID-approved energy meters, which have a guaranteed accuracy immediately following delivery and for their entire calibration period. The approval means that the measured values cannot be doubted and can be used across Europe for billing purposes.



▲ Energy meters in tough industrial environment



▲ Marking on an MID meter



▲ Production cell for energy meters in Murten

### Meters for converter connection

Through the use of current converters, costly shutdowns of entire machines for meter installation are becoming a thing of the past. The replacement of an energy meter or current converter while the system is running is possible with the consistent use of flap current converters, since the faulty parts can be replaced easily without disconnecting the entire system from the power supply.

### Available converter ratios in Saia PCD® energy meters

Single-phase alternating energy meters				Three-phase direct energy meters 5A sec. Current				Three-phase direct energy meters 1A sec. Current			
5:5	50:5	100:5	200:5	5:5	50:5	100:5	150:5	1:1	10:1	20:1	30:1
250:5	300:5	400:5	500:5	200:5	250:5	300:5	400:5	40:1	50:1	60:1	80:1
---	---	---	---	500:5	600:5	750:5	1000:5	100:1	120:1	150:1	200:1
---	---	---	---	1250:5	1500:5	---	---	250:1	300:1	---	---



▲ Current converter in switch cabinet

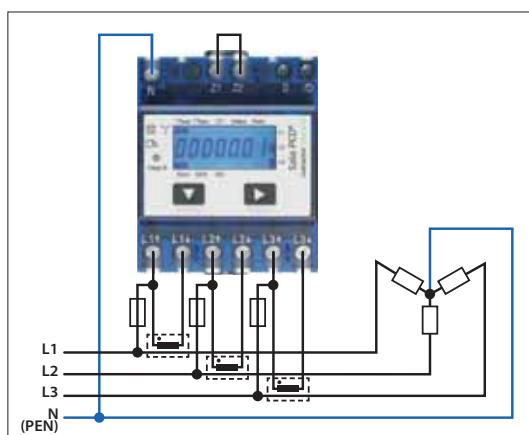

▲ Connected converter energy meter



▲ Built-in current converter directly in the cable duct

### MTBF values for Saia PCD® energy meters

The quality, robustness and reliability of the energy meters is also shown by the MTBF values, which have been calculated according to the Siemens standard SN 29500.

### MTBF values at 25 °C

Energy meters without communication interface: 410 years  
 Energy meters with communication interface: 200 years

## Measuring energy in both directions

With the bidirectional energy meters, energy can be measured in both directions of flow. The energy meters work in a balancing mode (Mode 2). This means that they form the sum of all measured phase outputs analogue to the old Ferraris meters with a rotating disc. The main area of use of bidirectional meters is wherever both energy flow directions occur (energy consumption and feed), such as in photovoltaic systems. For connection to the PCD world, FBoxes can be used which capture the measured values easily. Connection to the E-Monitor is possible directly, without additional manipulation.

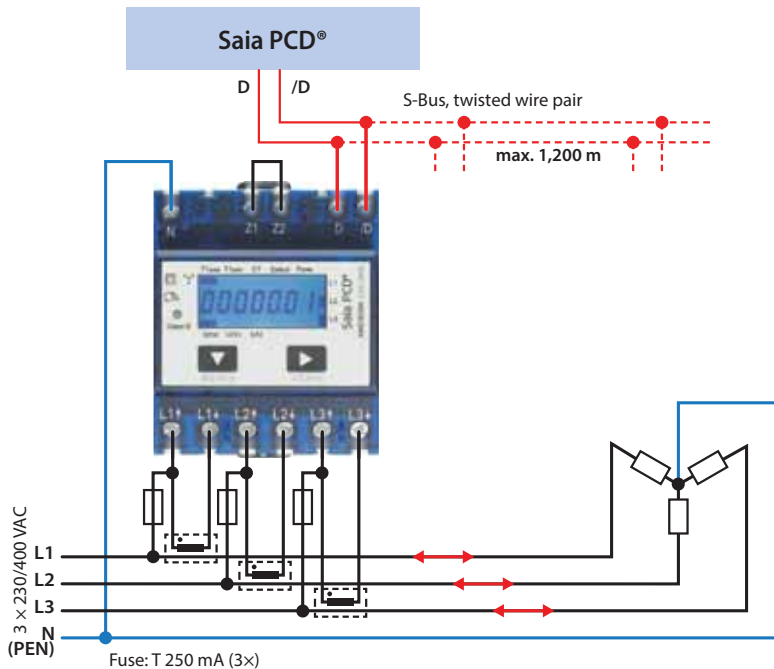

▲ Energy measurement of both current directions with one Saia PCD® for further processing of the measured values

**ePLAN®**  
electric P8

EPLAN macros are available for project planning and engineering

ePLAN®  
data portal



The eplan® electric P8 macros are available on the support page. The macros and article data is also provided on the eplan® data portal.

## Integrating the energy meter as a component in an existing, external system

The M-Bus energy meters can be integrated in any M-Bus system and can be read out with any M-Bus master. This enables use in existing systems with an existing M-Bus infrastructure or even in new projects with various other M-Bus components. The energy meters with integrated serial Modbus RTU interface enable fast and secure communication with superordinate systems. The market offers many components for data transfer, backup and visualisation of the measured data. Thanks to the wide variety, simple integration via various transmission channels is possible. With Modbus, the existing structure can be used without having to make expensive new purchases.

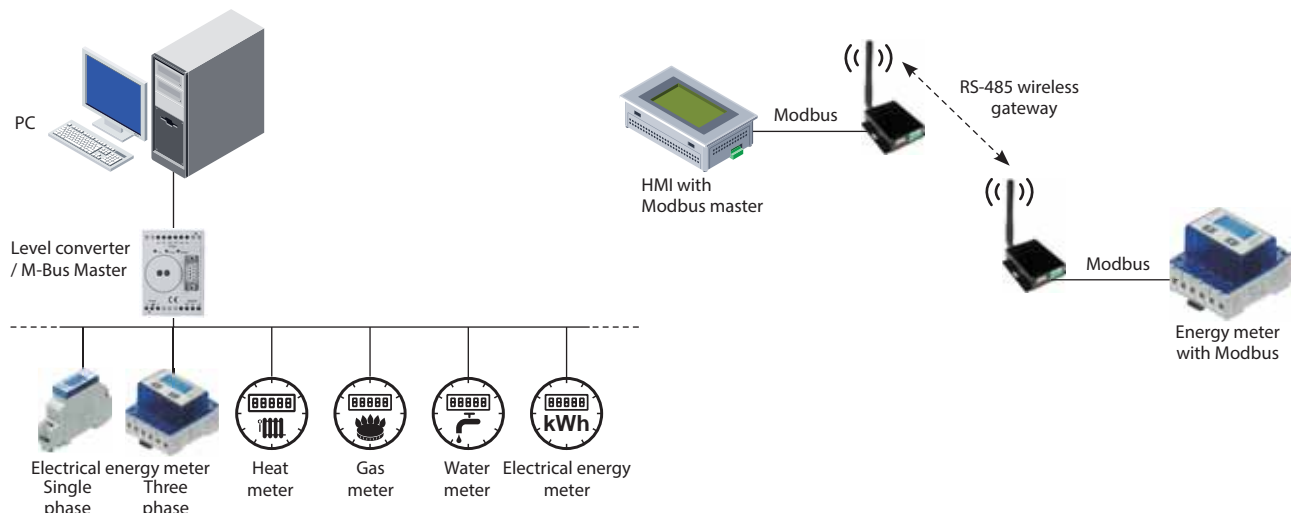

### 4.4.2 Saia PCD® energy meters with SBC S-Bus interface

The energy meters with integrated S-Bus interface offer all relevant data such as energy, current, voltage, output (active and reactive) and cosφ, which can be read out through the bus connection. The serial S-Bus interface (based on RS-485) can be connected directly to the Saia PCD® range of devices. For this connection, there are ready-made FBoxes for every meter type, which are available free of charge. The S-Bus energy meters are also available in a two-way design (bidirectional). On the display, the bus address can be set and the energy, current, voltage and active output can be read directly.

#### Connection diagram with an S-Bus energy meters

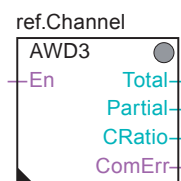
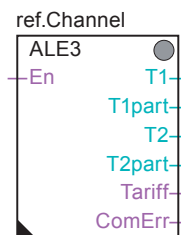
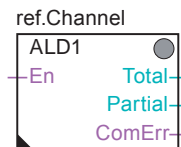
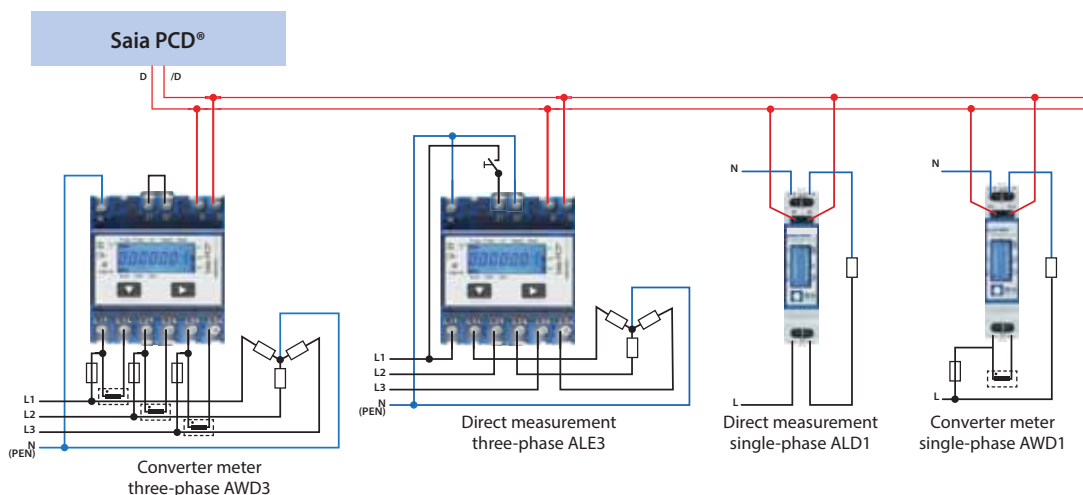

FBoxes available for every S-Bus meter type

#### Technical data

##### SBC S-Bus

Bus system	Serial RS-485 interface
Log	S-Bus data mode
Transmission rate	2400, 4800, 9600, 19,200, 38,400, 57,600, 115,200 Baud. The transmission rate is detected automatically.
Bus cable	Twisted, shielded, 2 × 0.5 mm <sup>2</sup> , max. 1,200 m
Response time	Write: up to 60 ms Read: up to 60 ms



		ALD1 / AWD1		ALE3				AWD3 / AWC3							
		ALD1D5F500A2A00	ALD1B5F500A2A00	ALD1D5F500A3A00	ALD1B5F500A3A00	AWD1D5W500A2A00	ALE3D5F510C2A00	ALE3B5F500C2A00	ALE3D5F510C3A00	ALE3B5F500C3A00	AWD3D5W500C2A00	AWD3B5W500C2A00	AWD3D5W500C3A00	AWD3B5W500C3A00	AWC3D5W500C2A00
Tariff	1 tariff	•	•	•	•	•	-	•	-	•	•	•	•	•	•
	2 tariffs	-	-	-	-	-	•	-	•	-	-	-	-	-	-
Meter type	Unidirectional design	•	-	•	-	•	•	-	•	-	•	-	•	-	•
	Bidirectional design	-	•	-	•	-	-	•	-	•	-	-	•	-	-
Approvals	With MID	-	-	•	•	-	-	-	•	•	-	-	•	•	-
	Without MID	•	•	-	-	•	•	•	-	-	•	•	-	-	•
Rated/Max. current	I <sub>min</sub> = 0.01 A, I <sub>N</sub> = 1 A, I <sub>max</sub> = 1.2 A	-	-	-	-	-	-	-	-	-	-	-	-	-	•
	I <sub>min</sub> = 0.05 A, I <sub>N</sub> = 5 A, I <sub>max</sub> = 6 A	-	-	-	-	•	-	-	-	-	•	•	•	•	-
	I <sub>min</sub> = 0.25 A, I <sub>N</sub> = 5 A, I <sub>max</sub> = 32 A	•	•	•	•	-	-	-	-	-	-	-	-	-	-
	I <sub>min</sub> = 0.5 A, I <sub>N</sub> = 10 A, I <sub>max</sub> = 65 A	-	-	-	-	-	-	•	•	•	-	-	-	-	-
Measurement type	Direct measurement	•	•	•	•	-	•	•	•	•	-	-	-	-	-
	Conversion up to 300 A	-	-	-	-	-	-	-	-	-	-	-	-	-	•
	Conversion up to 500 A	-	-	-	-	•	-	-	-	-	-	-	-	-	-
	Conversion up to 1500 A	-	-	-	-	-	-	-	-	-	•	•	•	•	-
Operating voltage	230 VAC, 50 Hz	•	•	•	•	•	•	•	•	•	-	-	-	-	-
	3 × 230/400 VAC, 50 Hz	-	-	-	-	-	•	•	•	•	•	•	•	•	•
Partial meter	Resettable	•	-	•	-	-	•	•	•	•	•	-	•	-	•



### 4.4.3 Saia PCD® energy meter with M-Bus interface

The M-Bus interface enables the connection and reading of measured data through any Saia PCD® or any desired M-Bus master. The meters correspond to M-Bus standard EN 13757. For connection to Saia PCD® systems, there are ready-made FBoxes, which are free of charge for Saia PCD® energy meters. The relevant measurement data, such as energy, current, voltage and output (active and reactive) can be read out via the M-Bus interface. On the display, the bus primary address can be set and the energy, current, voltage and active output can be read directly.

#### Connection diagram for M-Bus energy meters

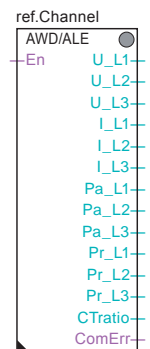
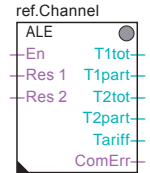
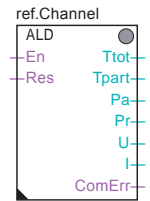
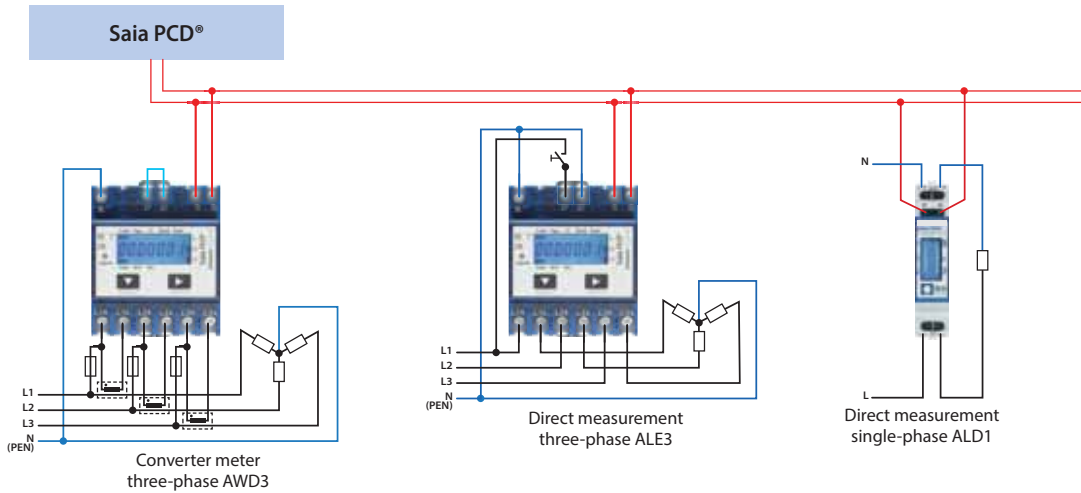

FBoxes available for every M-Bus meter type

#### Technical data

##### M-Bus

Bus system	M-Bus
Transmission rates	300, 2400, 9600 Baud. The transmission rate is detected automatically
Addressing	Primary and secondary
Bus length (max.)	In accordance with M-Bus specifications
Response time	Write: up to 60 ms Read: up to 60 ms



		ALD1		ALE3		AWD3	
		ALD1D5FM00A2A00	ALD1D5FM00A3A00	ALE3D5FM10C2A00	ALE3D5FM10C3A00	AWD3D5WM00C2A00	AWD3D5WM00C3A00
Tariff	1 tariff	•	•	-	-	•	•
	2 tariffs	-	-	•	•	-	-
Approvals	With MID	-	•	-	•	-	•
	Without MID	•	-	•	-	•	-
Rated/ max. current	$I_{min} = 0.05 \text{ A}, I_N = 5 \text{ A}, I_{max} = 6 \text{ A}$	-	-	-	-	•	•
	$I_{min} = 0.25 \text{ A}, I_N = 5 \text{ A}, I_{max} = 32 \text{ A}$	•	•	-	-	-	-
	$I_{min} = 0.5 \text{ A}, I_N = 10 \text{ A}, I_{max} = 65 \text{ A}$	-	-	•	•	-	-
Measurement type	Direct measurement	•	•	•	•	-	-
	Conversion up to 1,500 A	-	-	-	-	•	•
Operating voltage	230 VAC, 50 Hz	•	•	-	-	-	-
	$3 \times 230/400 \text{ VAC}, 50 \text{ Hz}$	-	-	•	•	•	•
Partial meter	Resettable	•	•	•	•	•	•



## 4.4.4 Saia PCD® energy meter with Modbus interface

The integrated Modbus RTU interface complies with the IDA specification and is based on an RS-485 interface. The measurement data from the energy meter can be connected to any desired Modbus master, in order to read out the measured values. The relevant measurement data, such as energy, current, voltage, output (active and reactive) and  $\cos\varphi$  can be read out via the interface. On the display, the bus address can be set and the energy, current, voltage and active output can be read directly. To connect the energy meters to Saia PCD® systems, there are ready-made FBoxes, which are provided free of charge.

### Connection diagram for Modbus energy meters

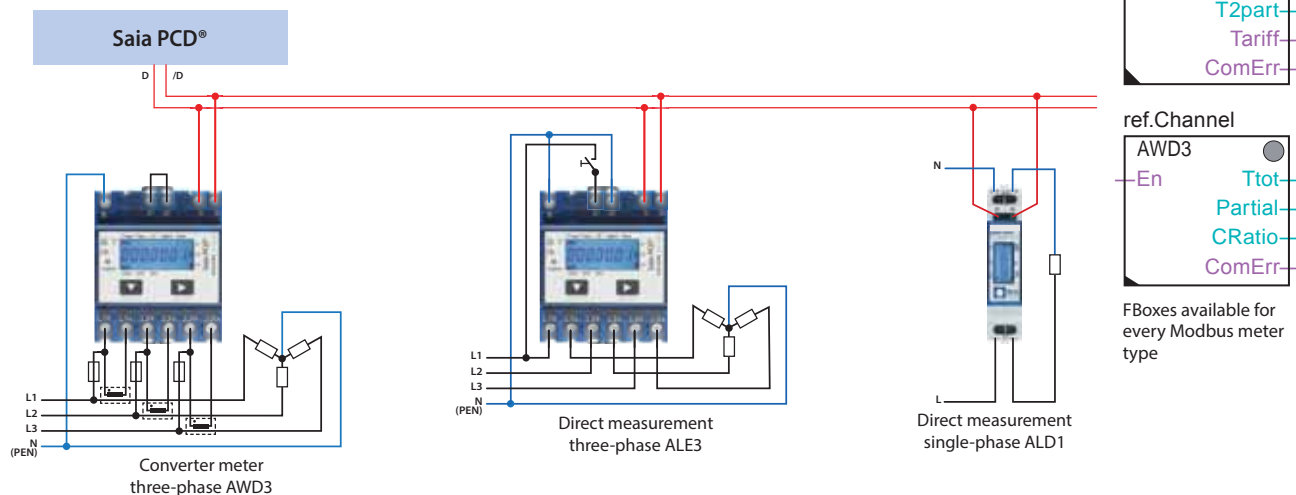

### Technical data

#### Modbus

Bus system	Serial RS-485 interface
Log	Modbus RTU as per IDA specification
Transmission rates	2400, 4800, 9600, 19,200, 38,400, 57,600, 115,200 Baud. The transmission rate is detected automatically
Bit settings	8 databit, even parity, 1 stop bit 8 databit, odd parity, 1 stop bit 8 databit, no parity, 2 stop bit The parity is automatically detected
Bus cable	Twisted, shielded, $2 \times 0.5 \text{ mm}^2$ , max. 1,200 m
Response time	Write: up to 60 ms Read: up to 60 ms



		ALD1	ALE3	AWD3
		ALD1D5FD00A2A00	ALE3D5FD10C2A00	AWD3D5WD00C2A00
		ALD1D5FD00A3A00	ALE3D5FD10C3A00	AWD3D5WD00C3A00
Tariff	1 tariff	•	•	•
	2 tariffs	-	-	-
Approvals	With MID	-	•	•
	Without MID	•	-	-
Rated/ max. current	$I_{\min} = 0.05 \text{ A}, I_N = 5 \text{ A}, I_{\max} = 6 \text{ A}$	-	-	•
	$I_{\min} = 0.25 \text{ A}, I_N = 5 \text{ A}, I_{\max} = 32 \text{ A}$	•	•	-
	$I_{\min} = 0.5 \text{ A}, I_N = 10 \text{ A}, I_{\max} = 65 \text{ A}$	-	•	•
Measurement type	Direct measurement	•	•	-
	Conversion up to 1500 A	-	-	•
Operating voltage	230 VAC, 50 Hz	•	•	-
	$3 \times 230/400 \text{ VAC}, 50 \text{ Hz}$	-	-	•
Partial meter	Resettable	•	•	•

## 4.4.5 Saia PCD® energy meter with S0 pulse output

Energy meters with integrated S0 interface enable the transfer of measured energy to the devices of the Saia PCD® family and the E-Monitor via pulses. With the S0 pulse counter PCD7.H104, the pulses can be requested via the RS-485 interface (S-Bus or Modbus).

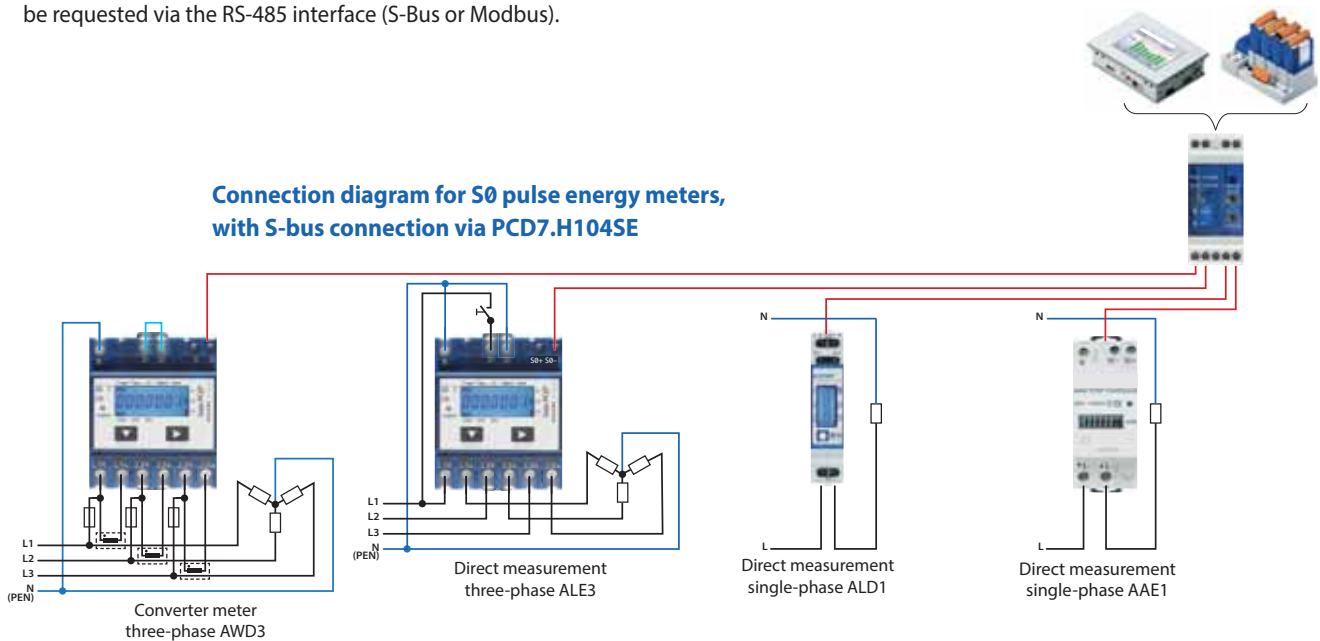

		ALD1				AAE1	ALE3				AWD3				
		ALD1D5F10KA2A00	ALD1B5F10KA2A00	ALD1D5F10KA3A00	ALD1B5F10KA3A00	AAE1D5F10KR3A00	ALE3D5F10KA2A00	ALE3B5F10KC2A00	ALE3D5F11KC3A00	ALE3D5F10KA3A00	ALE3B5F10KC3A00	AWD3D5W10MC2A00	AWD3B5W10MC2A00	AWD3D5W10MC3A00	AWD3B5W10MC3A00
Tariff	1 tariff	•	•	•	•	•	•	•		•	•	•	•	•	•
	2 tariffs	-	-	-	-	-	-	-	•	-	-	-	-	-	-
Meter type	Unidirectional design	•	-	•	-	•	•	-	•	-	•	-	•	-	•
	Bidirectional design	-	•	-	•	-	-	•	-	•	-	•	-	•	-
Approvals	With MID	-	-	•	•	•	-	-	•	•	-	-	•	•	
	Without MID	•	-	-	-	-	•	-	-	-	•	•	-	-	
Rated/ max. current	$I_{\min} = 0.05 \text{ A}, I_N = 5 \text{ A}, I_{\max} = 6 \text{ A}$	-	-	-	-	-	-	-	-	-	•	•	•	•	
	$I_{\min} = 0.25 \text{ A}, I_N = 5 \text{ A}, I_{\max} = 32 \text{ A}$	•	•	•	•	-	-	-	-	-	-	-	-	-	
	$I_{\min} = 0.5 \text{ A}, I_N = 10 \text{ A}, I_{\max} = 65 \text{ A}$	-	-	-	-	•	•	•	•	•	-	-	-	-	
Measurement type	Direct measurement	•	•	•	•	•	•	•	•	•	-	-	-	-	
	Conversion up to 1500 A	-	-	-	-	-	-	-	-	-	-	•	•	•	
Operating voltage	230 VAC, 50 Hz	•	•	•	•	•	-	-	-	-	-	-	-	-	
	$3 \times 230/400 \text{ VAC}, 50 \text{ Hz}$	-	-	-	-	-	•	•	•	•	•	•	•	•	
S0 output	1000 Imp./kWh	•	•	•	•	•	•	•	•	•	-	-	-	-	
	10 Imp./kWh	-	-	-	-	-	-	-	-	-	•	•	•	•	
Partial meter	Resettable	•	-	•	-	-	•	•	-	•	•	-	•	-	

## 4.4.6 Saia PCD® energy meter – sealing cover

### Accessories

### Order no.

#### Sealing cover for single-phase Saia PCD® energy meters ALD1 and AWD1

2 units are recommended for contact protection.

(Also for termination boxes PCD7.T161 and PCD7.T162, see Section 5.3)



4 104 7420 0



ALD1, AWD1 with assembled sealing cover

#### Sealing cover for

- Single-phase Saia PCD® energy meter AAE1
- Three-phase Saia PCD® energy meter ALE3, AWC3 and AWD3

2 units are recommended for contact protection on AAE1.

4 units are recommended for contact protection on ALE3, AWC3 and AWD3.



4 104 7485 0



ALE3, AWC3 or AWD3 with sealing cover

1 Automation stations

2 HMI Visualization and operating

3 Dedicated room controller

4 Consumption data acquisition

5 Cabinet components

## 4.4.7 Application notes

Application notes on the subject of "Energy" can be found on the support page ([www.sbc-support.com](http://www.sbc-support.com)) under the Section "Energy meters".



## 4.5 Basic functions of the S-Monitoring application

Function for automatic capturing and saving of energy meter values – integrated in the operating system of the Saia PCD®

The S-Monitoring application works on all controllers ending in xx60 and on the pWeb Panels. The application consists of a COSinus function and an associated Web Editor project. This makes it possible to capture, save and visualise data without significant programming effort. With S-Bus meters, this works without any program in the controller.



### S-Monitoring COSinus function

S-Monitoring is an integral part of the COSinus operating system and is integrated in all Saia PCD® controllers ending with xx60 and having the pWeb-Panel MB. It is activated in the PG5 Device Configurator and automatically scans connected meters. The data is saved on the file system. In addition to connected S-Bus meters, any meter values available in the program can also be integrated.

The S-Monitoring function can read three different types of meters:

- ▶ Connected S-Bus energy meters and pulse counters (PCD7.H104SE)
- ▶ Other incremental meter values (M-Bus, Modbus, etc. are referred to as “custom counters” and captured via FBoxes in the Fupla program)
- ▶ Groups of meters

The S-Monitoring COSinus function comprises the following three parts:

#### 1. Autoscan of S-Bus energy meters and pulse counters

If the S-Bus Autoscan is activated, meters connected to the RS-485 interface are automatically detected and read. By permanently requesting the meter data, remote diagnosis of the S-Bus meters and bus connection is possible.

<b>Current S-Bus address</b> 73	<b>Found meters</b> 5	<b>State</b> OK FW 1.3 HW 1.3 T1
------------------------------------	--------------------------	-------------------------------------

#### 2. Provision of meter values via NT-EM tags (CGI interface)

All data and basic functions can be called via CGI tags. These functions can therefore be accessed via the web interface or by other programs (e.g. Excel). The controller does not need a Fupla or IL program (see document 27/623).

NT-EM tag (CGI command) in the web browser:

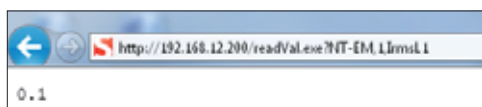

← Command  
← Value



#### Excel Report Tool

When the COSinus function is activated, the data can simply be imported into Excel without programming.

Download: [www.sbc-support.com](http://www.sbc-support.com)

#### 3. Saving the meter values in CSV files

The values of the energy meters connected are saved once a day at midnight in a CSV file on the internal file system of the PCD. The daily, weekly and monthly consumption can be calculated from this data. If an additional memory card is inserted, the values can be saved at 5-60 minute intervals. This makes it possible to visualise consumption over a day.

	A	B	C	D	E	F	G	H	I
1	Date	Energy1	Energy2	Tariff1	Tariff2	Energy3	Energy4	Tariff3	Tariff4
2	10.6.2013	206.10	0.00	0.1600	0.1300	160.00	13.23	0.1500	0.0800
3	11.6.2013	208.70	0.00	0.1600	0.1300	164.10	13.76	0.1500	0.0800
4	12.6.2013	214.43	0.00	0.1600	0.1300	168.13	14.82	0.1500	0.0800

## S-Monitoring web project

SBC delivers a PG5 project which also includes a web visualisation. The project is based on the COSinus functions and enables saved data to be visualised on the PC immediately. As only the S-Monitoring COSinus function is accessed in the web project, it does not need a PG5 program. It can therefore be easily integrated in existing projects. In addition, the most important websites are available as macros in Web Editor 8.



Meter Name	Vk Tot	State	OK
S-Bus address	1	FW1.3	HW1.3 T1
Phase	1	2	3
Voltage	221 V	227 V	221 V
Current	21 A	20 A	21 A
Power	4.6kW	4.2kW	4.7kW
T1 total	163641.0kWh		
T1 Part.	36961.6kWh		



Complete overview of the basic application















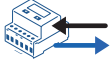



S-Monitoring is also supported by pWeb Panel PCD7.DxxxxT5F, PCD1.M2160 and PCD3xx60



In the PG5 application for the E-Controller and E-Monitor products provided ready for use upon delivery from the factory, additional "Advanced" functions are programmed in PG5. These cannot therefore be used without the program.

## Basic functions of the S-Monitoring application

Capturing of energy values	
 Automatic detection of connected energy meters	 Display of the energy meter status
 Grouping of the energy meters	 Comparison between meters and periods
 Connection of bidirectional meters	 Connection of H104SE coupler modules (for S0 meters)
Presentation and evaluation of energy values	
 Current meter readings such as consumption, voltage, current, active and reactive output and cosφ	 Evaluation and presentation of the costs
 Visualisation in bar charts and trend diagrams	 Consumption and costs presentation per day/week/month/year <sup>1)</sup>
 Data storage in Excel-readable CSV files	
Remote access via network and Internet	
 Operation at the PC with standard browser (IE, Chrome, Firefox)	 Operation via smartphone and tablet
 Access to log data and web project with FTP	 Integrated USB port for update and maintenance
User support	
 User administration with up to 2 user levels	 User interface in several languages

<sup>1)</sup> Daily view only available if memory extension is plugged in

## Technical data for SBC S-Monitoring

SBC S-Monitoring COSinus function integrated in	PCD1.M0160E0 (E-Controller) PCD1.M2160	PCD3.Mxx60 PCD7.DxxxxT5F (pWeb Panel MB)	PCD7.D457VT5E (E-Monitor)
Supported meters	<ul style="list-style-type: none"> <li>- Saia PCD® S-Bus energy meters, PCD7.H104SE pulse counters</li> <li>- Incremental meter values (M-Bus, Modbus, etc. are referred to as "custom counters" and captured via FBoxes in the Fupla program)</li> <li>- Meter groups</li> </ul>		
Maximum number of meters	128 Saia PCD® S-Bus meters* / 256 custom counters* / 32 groups*		*in total max. 256
Data storage time	Max. 4 years		
Saved data	Max. 4 meter values with 4 tariffs per meter are saved once a day (at midnight)		

## 4.6 Saia PCD® E-Monitor

The E-Monitor is an SBC functions HMI, which can be used immediately upon delivery, without additional programming. It combines data capture, visualisation and logging in one compact device. Energy meters and pulse counters connected via the S-Bus interface are automatically detected and read. Historical data and the web visualisation can be accessed from anywhere via the integrated Automation Server using FTP and HTTP. This is also possible with mobile devices using SBC apps.

In addition to the basic functions described in Section 4.5, simple control functions are already realised on the E-Monitor. These include sending data e-mails and the parallel recording of several load profiles.

The pre-installed S-Monitoring application can be adjusted, extended or changed completely as required using PG5 and Web Editor. With the optional communication interfaces, further protocols and data (e.g. from an M-Bus meter) can be integrated.

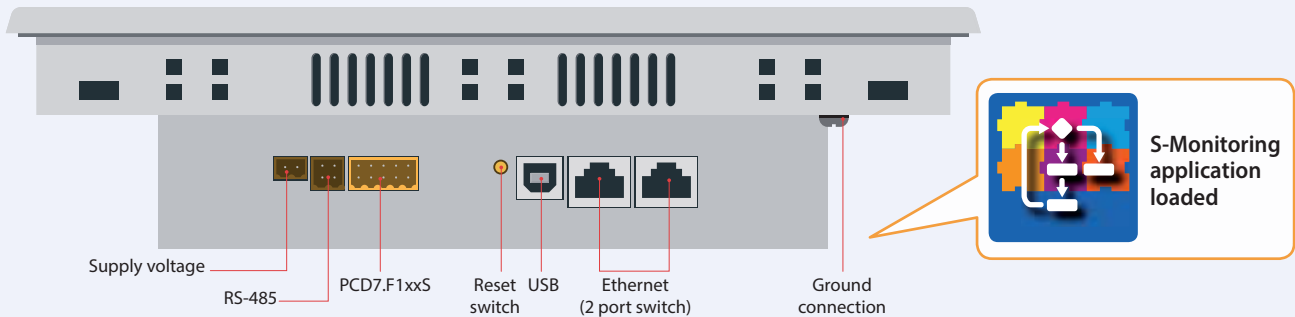

### Advanced functions

In addition to the basic functions of the S-Monitoring application (4.5), the E-Monitor Web Panel includes the following functions, which are programmed in Saia PG5®:



Load profile measurement of 8 consumption values



Sending of data e-mail to up to 5 e-mail addresses



Load profile measurement

### Summary of functions

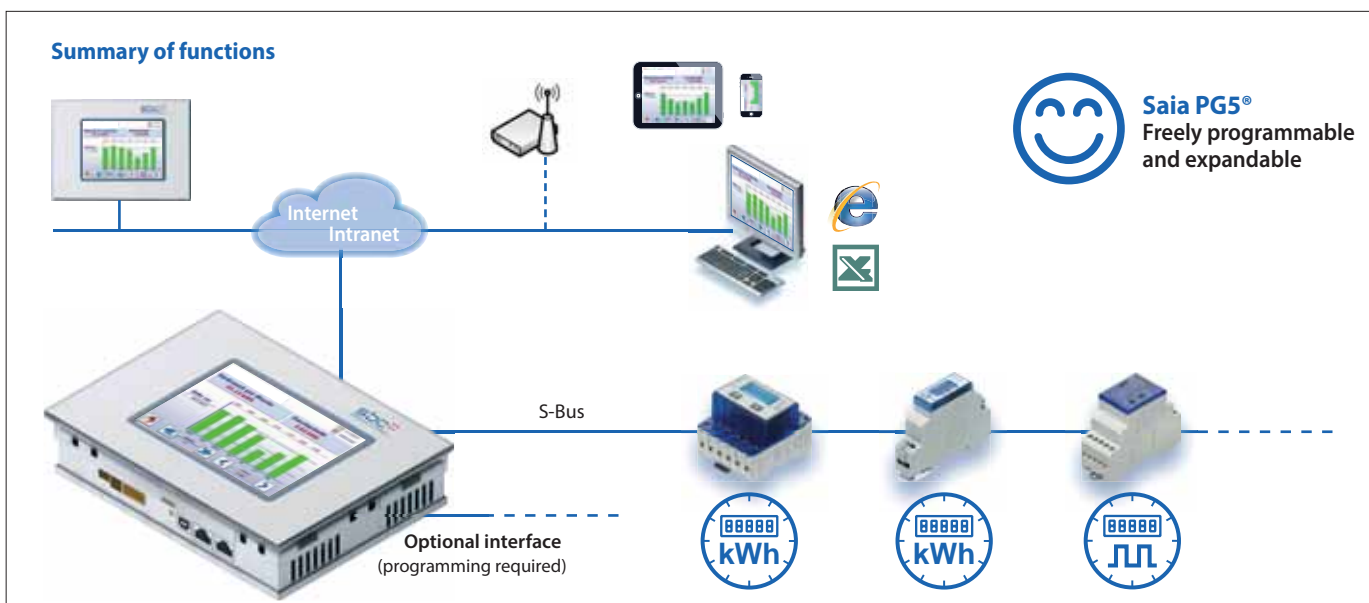



## Dimensions (W × H × D) and cut-out (W × H), [mm]

### PCD7.D457VT5E0

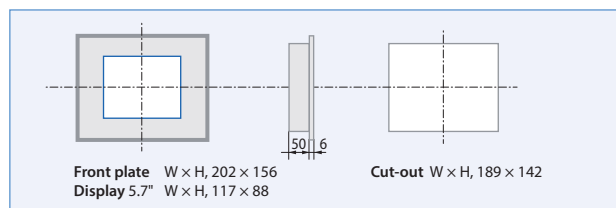

### SBC MB App

Operation and monitoring on iPhone, iPad and Android



Web code scen13063

### E-Monitor wall mounting set 5.7"

Q.OWSD457VT5E0

#### The package includes:

- ▶ Wall mounting kit with 5.7" PCD7.D457-OWS1
- ▶ E-Monitor 5.7" PCD7.D457VT5E0
- ▶ Mains adapter 24 VDC Q.PS-AD2-2402F
- ▶ Memory extension PCD7.R610 and PCD7.R-MSD1024
- ▶ Cabling



### Memory extension

Enables logs at 5–60 minute intervals and presentation of the daily figures in a bar chart for all meters.



PCD7.R610  
Holder module for microSD card



PCD7.R-MSD1024  
MicroSD memory card 1 GB,  
PCD formatted

## Overview of PCD7.D457VT5E0

### General data

Operating system	Saia PCD® COSinus with Micro-Browser expansions
Protection class	IP65
User program, ROM/DB/Text	1 MB
RAM/DB/Text	1 MB
Media	16,384 flags / 16,384 registers
Backup for users	The user program is saved on the integrated microSD card
File system for users	128 MB onboard
Program cycle time	10 cycles/sec. maximum
Field level protocols	Serial-SBC S-Bus, Ether-SBC S-Bus, Ether-S-IO, Modbus RTU or TCP
Internet services	SBC Micro-Browser, Automation Server

### Interfaces

Ethernet	2 × RJ-45 (Switch)
USB	1 × (1.1 / 2.0)
Serial interfaces	RS-485 1 slot for PCD7.F1xxS
Temperature range	When in operation: 0...50 °C standard When stored: -25...70 °C
Humidity	When in operation: 10...80%, When stored: 10...98%, non-condensing
Processor	Coldfire CF5373L, 240 MHz
Battery	Lithium Renata CR 2032 (lifetime of 1–3 years)
Real-time clock (RTC)	with battery buffer

### Display

Size	5.7" TFT
Resolution / pixels	VGA 640 × 480
Touchscreen	Resistive touchscreen
Contrast adjustment	Yes
Background lighting	LED
Power supply	24 VDC ±20 %
Current draw	max. 500 mA
Protection class (front)	IP 65

### Connection example M-Bus with external interface<sup>1)</sup>

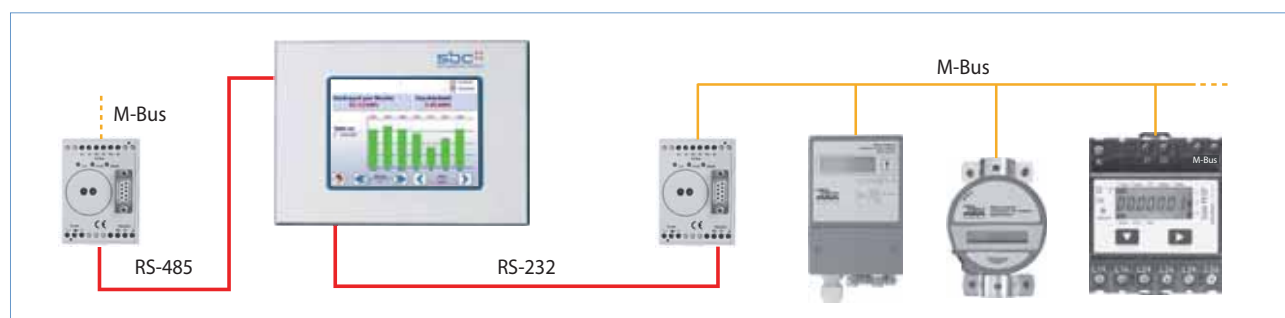

<sup>1)</sup> Programming required

## 4.7 Saia PCD® E-Controller

Can be used immediately upon delivery, with local IOs

The E-Controller is an SBC functions PCD, which can be used immediately upon delivery, without additional programming. It combines data capture, decentralized visualisation and logging in one compact device. Energy meters and pulse counters connected via the S-Bus interface are automatically detected and read. Historical data and the web visualisation can be accessed from anywhere via the integrated Automation Server using FTP and HTTP. This is also possible with mobile devices using SBC apps.

In addition to the basic functions described in Section 4.5, simple control functions are already realised on the E-Controller.

These include sending alarm e-mails and the parameterization of outputs according to the meter readings.

The pre-installed S-Monitoring application can be adjusted, extended or changed completely as required using PG5 and Web Editor.

With the optional communication interfaces, further protocols and data (e.g. from an M-Bus meter) can therefore be integrated.

As a result of its design, this controller is suitable for installation in the distribution board next to the energy meters.



### Device installation

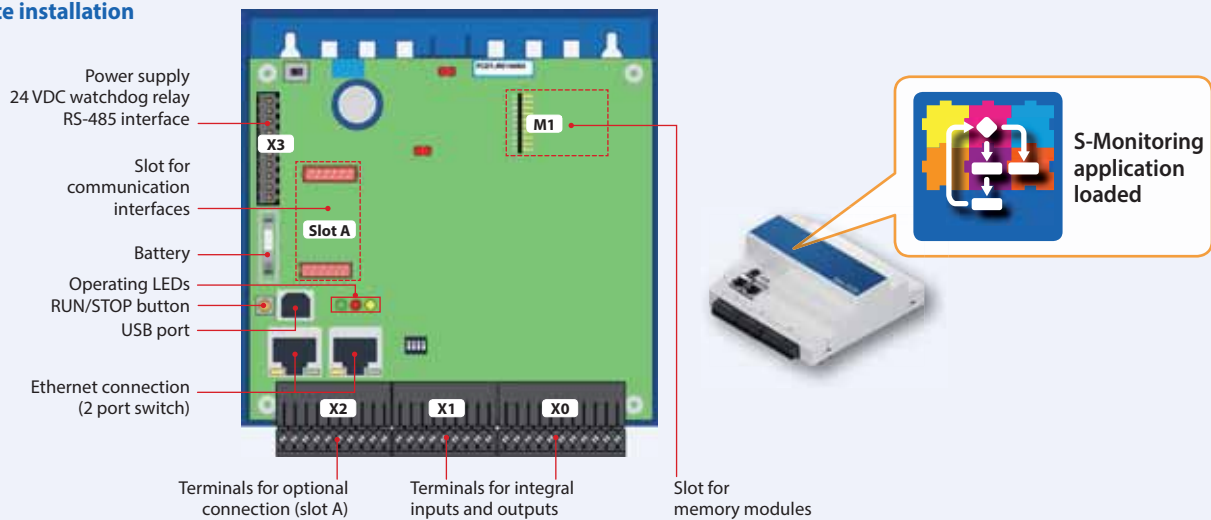

### Advanced functions

In addition to the basic functions of the web application (4.5), the E-Controller includes the following functions, which are programmed with Saia PG5®:



Load profile measurement of 8 consumption values



Sending of alarm and data e-mails to up to 5 e-mail addresses



Parameterization of outputs via min. and max. values

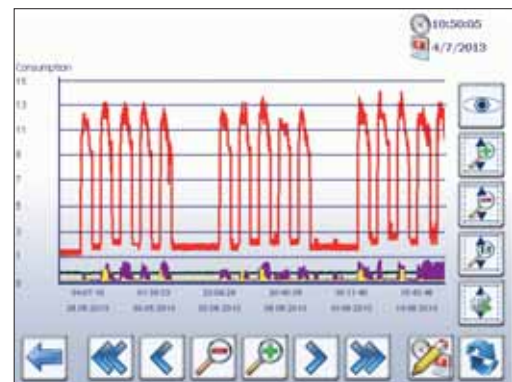

Load profile measurement

### Mounting

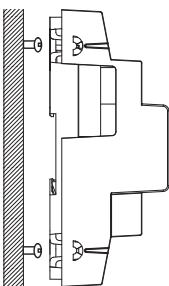

on a level surface

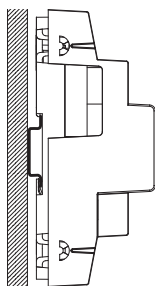

on top-hat rail 35 mm  
(pursuant to DIN EN 60715  
TH35)

### Dimensions

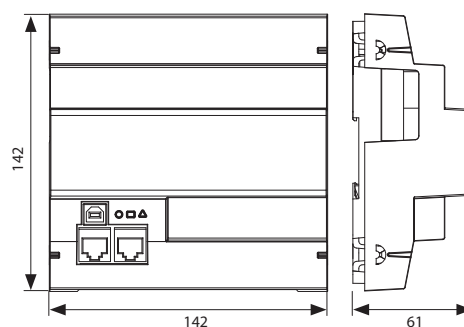

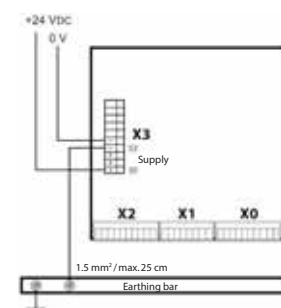

### Power supply and connection plan

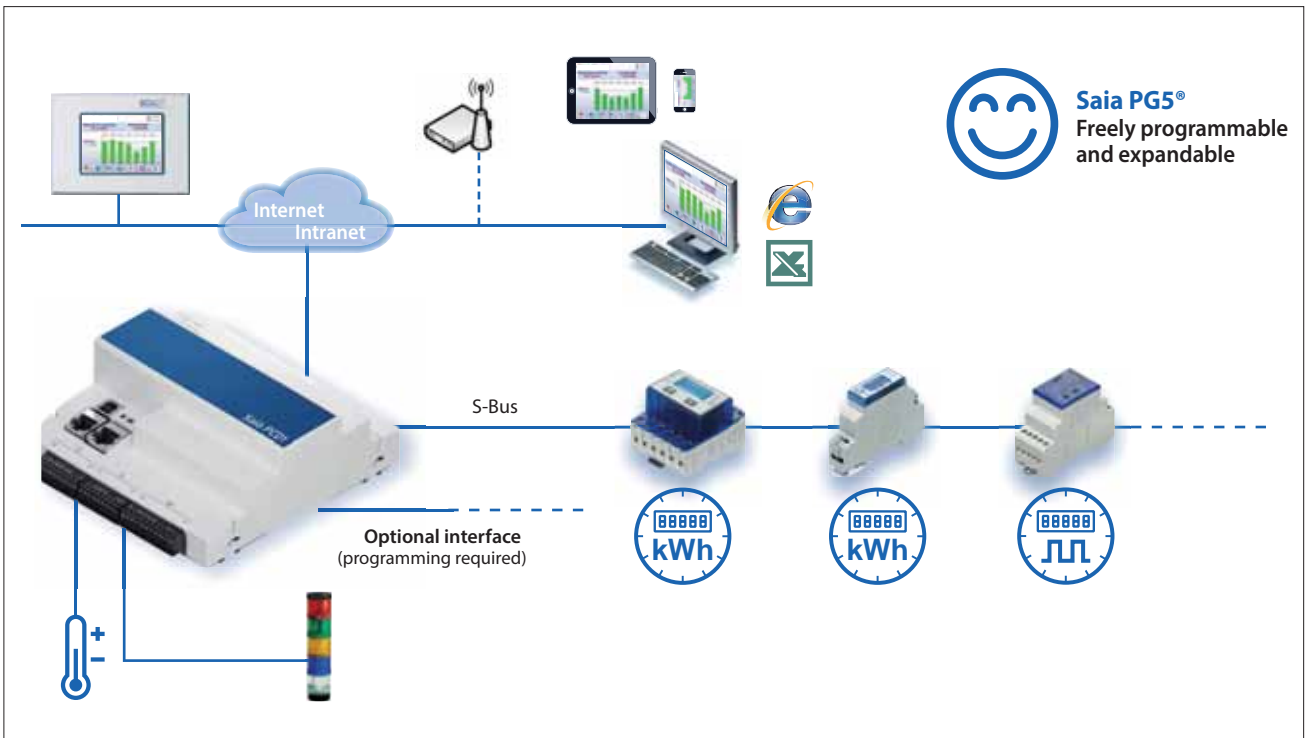

Further information is provided in Section 1.2.1 Saia PCD3 power supply and connection plan, and in Manual 26-875.

## Summary of E-Controller functions



 Both the automatic detection of the meters and the E-Monitoring functionality can be switched off in the PG5 Device Configurator for unrestricted use of PCD1.M0160E0.

**SBC MB App**  
Operation and monitoring on iPhone, iPad and Android







### Memory extension

Enables logs at 5–60 minute intervals and the presentation of the daily figures in a bar chart for all meters.

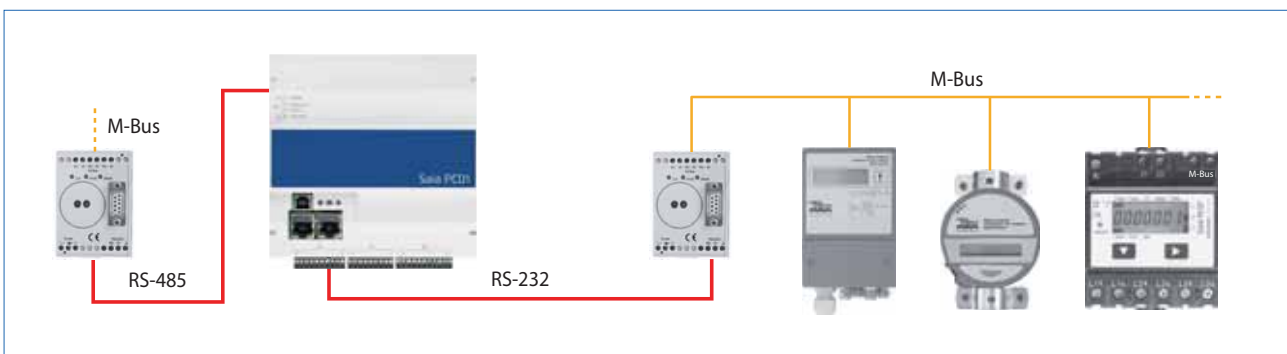

### Connection example of M-Bus with external interface<sup>1)</sup>



<sup>1)</sup> Programming required

1 Automation stations

2 HMI Visualization and operating

3 Dedicated room controller

4 Consumption data acquisition

5 Cabinet components

## Overview of Saia PCD® E-Controller

### Technical data

PCD1.M0160E0

#### Memory and file system

Program memory, DB/text (Flash)	1 MB
User memory, DB/text (RAM)	1 MB
User Flash file system onboard	128 MB

#### Integrated communication

Ethernet connection (2 port switch) 10/100 Mbit/s, full-duplex, auto-sensing, auto-crossing	Yes
USB port USB 1.1 device 12 Mbit/s	Yes
RS-485 (terminal X3) up to 115 kbit/s	Yes

### General data

Operating voltage	24 VDC, -20/+25 % max. incl. 5 % ripple (in accordance with EN/IEC 61131-2)
Battery for data backup (replaceable)	Lithium battery with a service life of 1 to 3 years
Operating temperature	0...55 °C
Dimensions (W × H × D)	142 × 142 × 60 mm
Mounting type	Top-hat rail according to DIN EN 60715 TH35 (1 × 35 mm) or on a level surface
Protection type	IP 20
Capacity 5 V/+V (24 V) internal	max. 500 mA/200 mA
Power consumption	typically 12 W
Automation Server	Flash memory, file system, FTP and web server, e-mail, SNMP



### On-board inputs/outputs

#### Inputs

6	Digital inputs (4 + 2 interrupts)	15 - 30 VDC, 8 ms / 0.2 ms input filter	Terminal X1
2	Analogue inputs, selectable via DIP switch, preconfigured for Ni1000 in the default setup	-10...+10 VDC, 0...+/-20 mA, Pt1000, Ni1000, Ni1000 L&S, 0...2.5 kΩ, 12 Bit resolution	Terminal X1

#### Outputs

4	Digital outputs	24 VDC / 0.5 A	Terminal X0
1	PWM output	24 VDC / 0.2 A	Terminal X0

#### selectable/configurable via PG5

4	Digital inputs or outputs, preconfigured for digital inputs in the default setup	24 VDC / data such as digital inputs or digital outputs	Terminal X0
1	Watchdog relay or as make contact	48 VAC or VDC, 1 A With DC turn-on voltage a free-wheeling diode should be connected in parallel to the load	Terminal X3

## Installation notes and recommendations

### Assembly in the distribution board

The Saia PCD1.M0160E0 has the dimensions 142 × 142 × 60 mm excluding terminals and connections.

For easy assembly, a gap of 55 mm above the DIN rail and 75 mm below it is recommended.

### Ethernet cable

For installation in the sub-distributor, an angled or flexible network cable (e.g. SlimWire PRO) is recommended.

With installation of a conventional network cable, assembly of the sub-distributor cover cannot be guaranteed.

→ For interface options and accessories, see Section 1 "Automation stations – PCD1"

# A5

## Cabinet components

The comprehensive range of accessories for automation technology from Saia Burgess Controls (SBC) makes reliable operation of the systems possible. In addition to power supplies and Ethernet switches, modules such as isolating amplifiers, coupler modules and relays are available.

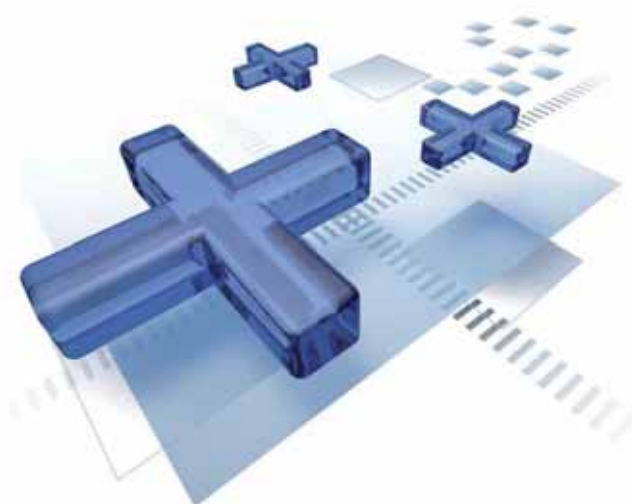

### 5.1 SBC Power supplies

Page 135

Different types of 24 VDC power supplies with diverse output power



### 5.2 SBC industrial Ethernet switch

Page 138

Industry-quality compact switches for top-hat rail mounting with 5 or 8 ports



### 5.3 SBC RS-485 bus termination box

Page 139

Termination box for the termination of RS-485 networks for top-hat rail mounting with 24 V or 230 V power supply



### 5.4 SBC isolating amplifiers

Page 140

Isolating amplifiers for electrical isolation of analog signals from the switch cabinet potential



### 5.5 SBC coupler modules with manual operation

Page 141

Coupler modules to control drives, valves or flap systems



### 5.6 SBC timer delay relays

Page 142

SBC timer delay relays for the setting up of switch-on or switch-off delays for the safe operation of systems



### 5.7 SBC monitoring relays

Page 143

Voltage, current and symmetry monitoring, and short-circuit and cable-break monitoring of motors







## 5.1 SBC Power: Power supplies with 24 VDC output

Thanks to their high level of resistance to interference, the power supplies from SBC provide an ideal power supply for automation solutions. As they can be heavily overloaded for a short period, high-output loads can also be operated with them. The full extent of their flexibility can be seen in the option of connecting multiple devices in parallel in order to increase the maximum output current or connecting them in series in order to achieve different voltage levels.

### Power unit overview

#### SBC Power Flex single phase 110/230 VAC

- ▶ Q.PS-AD2-2402F (up to 3 A)
- ▶ Q.PS-AD2-2405F (up to 7.5 A)
- ▶ Q.PS-AD2-2410F (up to 14 A)

#### SBC Power Flex single phase or double phase 230/400 VAC

- ▶ Q.PS-AD3-2405F (up to 7.5 A)

#### Uninterruptible power supply single phase 110/230 VAC with intelligent battery charger

- ▶ Q.PS-ADB-2405-1 (5 A)

#### SBC CC single phase 28 VAC/40 VDC

- ▶ Q.PS-AD1-2403 (3 A)
- ▶ Q.PS-AD1-2405 (5 A)



From left to right: Q.PS-ADB, Q.PS-AD2, Q.PS-AD1

### System properties in general

- ▶ Short-circuit protection
- ▶ Overload protection
- ▶ IP 20 housing for mounting on DIN rail

### Properties of Flex types 24xxF

- ▶ Power boost: +40% extra output current up to 60°C for at least 3 minutes
- ▶ With AD2/3-2405F and 2410F, different short-circuit modes available
- ▶ 'Power good' relay for status display
- ▶ With 2410F, simple parallel connection (via jumper) to increase max. output current
- ▶ In serial mode, output voltage up to 150 VDC possible
- ▶ Extremely small size
- ▶ AD3-2405F can be used as either a single phase or double phase power unit

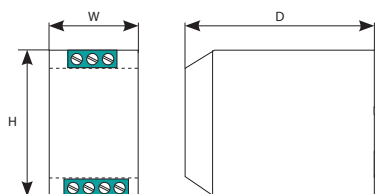

### Properties of the uninterruptible power supply

- ▶ 3-stage automatic charging curve to compensate the self discharge of the battery
- ▶ Automatic real-time diagnosis of the battery status and test function to find out the lifetime of the battery
- ▶ Any battery fault can be easily identified via blinking codes of the diagnostics LED
- ▶ Option of status and battery fault reporting in the control system via 2 potential-free contacts
- ▶ Adjustable charging current 1...5 A

### Norms and certifications

- ▶ According to
  - EMC 2004/108/EEC
  - Low voltage 2006/95/EEC
  - cULus Listed 508 Industrial Control Equipment

#### Electrical safety:

According to IEC/EN60950 (VDE 0805) and EN50178 (VDE0160) for assembling devices. The unit must be installed according to IEC/EN56090.

#### EMC Generic:

Immunity according to EN61000-6-2  
Noise emission according to EN61000-6-4

Dimensions	Q.PS-AD2-2402F	Q.PS-AD2-2405F	Q.PS-AD2-2410F	Q.PS-AD3-2405F	Q.PS-ADB-2405-1	Q.PS-AD1-2403	Q.PS-AD1-2405
Width (W)	50 mm	55 mm	72 mm	55 mm	65 mm	50 mm	50 mm
Height (H)	120 mm	110 mm	115 mm	110 mm	115 mm	95 mm	95 mm
Depth (D)	50 mm	105 mm	135 mm	105 mm	135 mm	61 mm	61 mm
Weight	0.3 kg	0.6 kg	0.6 kg	0.6 kg	0.6 kg	0.2 kg	0.2 kg

# SBC Power: Technical data

	Q.PS-AD2-2402F	Q.PS-AD2-2405F	Q.PS-AD2-2410F
<b>Input data</b>			
Input voltage	115...230 VAC		
Permitted voltage range:	90...264 VAC	90...135 / 180...264 VAC	
Inrush current (at $V_n$ and $I_n$ )	$\leq 7 \text{ A} \leq 5 \text{ ms}$	$\leq 11 \text{ A} \leq 5 \text{ ms}$	$\leq 16 \text{ A} \leq 5 \text{ ms}$
Input frequency	47...63 Hz ( $\pm 6\%$ )		
Input current (at operating voltage)	1.0...0.7 A	2.8...1.0 A	3.3...2.2 A
Internal fuse	4 A		6.3 A
External fuse recommended	Fast-acting 6 A	Fast-acting 10 A	Fast-acting 14 A

	Q.PS-AD2-2402F	Q.PS-AD2-2405F	Q.PS-AD2-2410F
<b>Output data</b>			
Output voltage ( $V_n$ ) / nominal current ( $I_n$ )	24 VDC $\pm 3\%$ / 2.5 A	24 VDC $\pm 3\%$ / 5 A	24 VDC $\pm 3\%$ / 10 A
Adjustment range ( $V_{adj}$ )	22...27 VDC		
Switch-on delay	2 s (max.)	1 s (max.)	
Start-up with capacitive load	$\leq 50000 \mu\text{F}$		
Continuous running at $\leq 40^\circ\text{C}$	3 A (230 VAC)/2 A (115 VAC)	7.5 A	14 A
Continuous running at $\leq 50^\circ\text{C}$	2.5 A (230 VAC)/1.5 A (115 VAC)	6.0 A	12 A
Continuous running at $\leq 60^\circ\text{C}$	---	5.0 A	10 A
Maximum continuous current	---	---	---
Reserve out current (within 3 minutes at $\leq 60^\circ\text{C}$ )	3.5 A	7.5 A	14 A
Short-circuit current ( $I_{sc}$ )	7 A	16 A	30 A
Residual ripple	$\leq 80 \text{ mVpp}$		
Efficiency (at 50% in)	$\geq 88\%$	$\geq 91\%$	
Short-circuit protection	Yes	Yes + 3 modes	
Overload protection	Yes		
Overvoltage output protection	Yes (max. 35 VDC)		
Parallel connection	Yes	Yes – simple	

	Q.PS-AD2-2402F	Q.PS-AD2-2405F	Q.PS-AD2-2410F
<b>Signal output (floating switch contacts)</b>			
Switching capacity	---	1 A / 30 VDC	
Voltage drop $>10\%$	---	Yes	

	Q.PS-AD2-2402F	Q.PS-AD2-2405F	Q.PS-AD2-2410F
<b>Climatic data</b>			
Ambient temperature (operation)	$-25 \dots +70^\circ\text{C}$ Derating $>50^\circ\text{C}$ , 2.5%/°C)	$-25 \dots +70^\circ\text{C}$ Derating $>60^\circ\text{C}$ , 2.5%/°C)	
Ambient temperature (storage)	$-40 \dots +85^\circ\text{C}$		
Humidity, no moisture condensation	95 % at $+25^\circ\text{C}$		

## Overload protection

Mode

Jumper

Characteristic

Hiccup mode

Automatic restart (default setting)  
Attempts to switch on the output voltage again every 2 seconds.

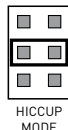

HICCUP MODE

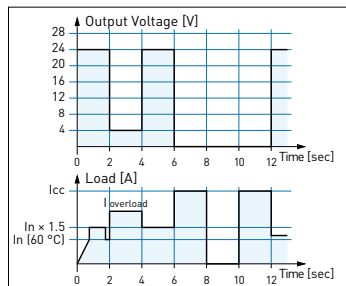

Manual reset mode

For a restart, it is necessary to switch off the input voltage for approx. 1 minute.

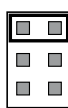

MANUAL RESET

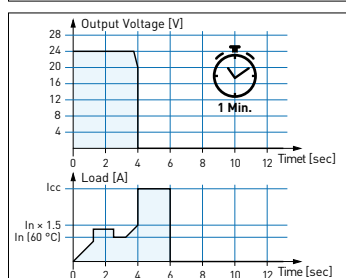

Mode

Jumper

Characteristic

Continuous out mode

The output current remains at a high value and the output voltage is almost 0 volts.

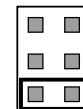

CONTINUOUS OUT MODE

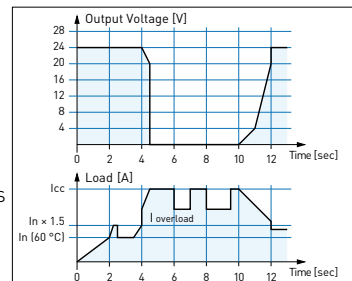

	Q.PS-AD3-2405F	Q.PS-ADB-2405-1 Battery type	Q.PS-AD1-2403	Q.PS-AD1-2405
	230 VAC / 400...500 VAC	115...230 VAC	28 VA / 40 VDC	
	187...264 VAC / 330...550 VAC	93...264 VAC	24...32 VAC / 33...45 VDC	
	$\leq 17 \text{ A} \leq 5 \text{ ms}$	$\leq 14 \text{ A} \leq 5 \text{ ms}$	47...63 Hz ( $\pm 6\%$ )	
	1.5 / 0.8 A	1.5...0.9 A	---	
	4 A		---	
	Fast-acting 10 A	Fast-acting 6 A	Fast-acting 4 A	Fast-acting 6 A

	24 VDC $\pm 3\%$ / 5 A	24 VDC / 5 A	24 VDC $\pm 2\%$ / 3 A	24 VDC $\pm 2\%$ / 5 A
	22...27 VDC	---	---	
	1 s (max.)	2.5 s (max.)	$\leq 100 \text{ ms}$	
	$\leq 50\,000 \mu\text{F}$	$\leq 30\,000 \mu\text{F}$	$\leq 30\,000 \mu\text{F} / 1.5 \text{ A}$	$\leq 30\,000 \mu\text{F} / 2 \text{ A}$
	7.5 A	---	---	
	6.0 A	---	3 A	3.5 A
	5.0 A	---	---	
	---	$1.1 \times I_n \pm 5\%$	$1.05 \times I_n \pm 7\%$	
	7.5 A	---	---	
	16 A	---	---	
	$\leq 80 \text{ mVpp}$	$\leq 60 \text{ mVpp}$		
	$\geq 91\%$	$\geq 81\%$	$\geq 88\%$	
	Yes + 3 modes	Yes		
	Yes			
	Yes (max. 35 VDC)	Yes	---	
	Yes	---	---	

	1 A / 30 VDC	1 A / 30 VDC	---	
	Yes	---	---	

	-25...+70 °C Derating >60 °C, 2.5%/°C)	-25...+70 °C Derating >50 °C, 2.5%/°C)	-0...+50 °C	
	-40...+85 °C		-25...+85 °C	
	95 % at +25 °C			

### Battery output

(battery type 3 ... 50 Ah)

Boost charge (25 °C) (at $I_n$ )	28.8 VDC
Trickle charge (25 °C) (at $I_n$ )	27.5 VDC
Output 2: Battery charging current max. $I_{\text{batt}}$	5 A $\pm 5\%$
Setting range of charging current	20...100% of $I_n$
Recovery charge after deep discharge	Yes
Configuration jumper: Battery type	Yes
Reverse polarity protection	Yes
Monitoring of the sulfation of the battery cells	Yes
Detection of an element in short circuit	Yes

### Load output

Output voltage (at $I_n$ )	22...28.8 VDC
Max. nominal current $I_n = I_{\text{load}} + I_{\text{batt}}$ (120 W)	$1.1 \times 5 \text{ A} \pm 5\%$
Output 1: Load current (main) $I_{\text{load}}$	15 A max.
Output 1: Load current (backup) $I_{\text{load}}$	10 A max.

### Signal output

(floating switch contacts)

Switching capacity	1 A / 30 VDC
Main or backup power	Yes
Defective battery/low battery	Yes

## Output characteristics

### Output derating curve

Q.PS-AD2-2402F

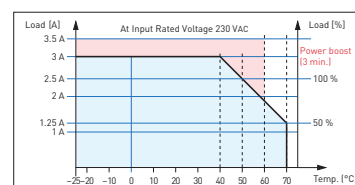

### Output derating curve

Q.PS-AD1-2403  
Q.PS-AD1-2405  
Q.PS-ADB-2405-1

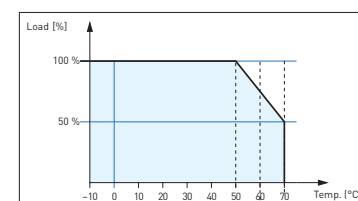

### Output derating curve

Q.PS-AD2-2405F  
Q.PS-AD3-2405F

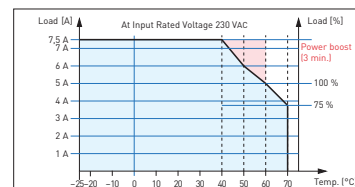

### Output derating curve

Q.PS-AD2-2410F

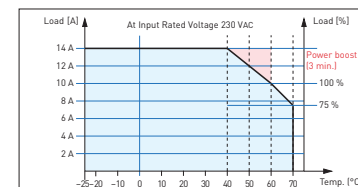

## 5.2 SBC industrial Ethernet switch Q.NET-xTX

This compact, unmanaged switch operates according to the plug-and-work principle. The mounted switch is equal in height to Saia PCD3 systems, which saves space when it is snapped onto the top-hat rail. The PCD controller is connected with the patch cable provided. With its robust construction, this switch is suitable for use in rugged industrial environments and in infrastructure automation.

### System properties

- ▶ Top-hat rail mounting and 24 VDC supply for trouble-free use in infrastructure automation and in rugged industrial environments
- ▶ Fast network diagnosis, due to integral LEDs at TCP ports
- ▶ Entry level industrial Ethernet rail switch, with store-and-forward switching mode
- ▶ Allows construction of Ethernet networks according to IEEE 802.3 with copper technology
- ▶ The device has five or eight 10/100 Mbit/s twisted pair ports (RJ 45 connections)
- ▶ Up to five or eight end devices or additional TCP segments can be connected to the TCP ports via twisted pair
- ▶ Extremely light, compact construction with IP 30 protection level
- ▶ Simple commissioning with 'plug-and-work' via auto-negotiation, auto-polarity and auto-crossing

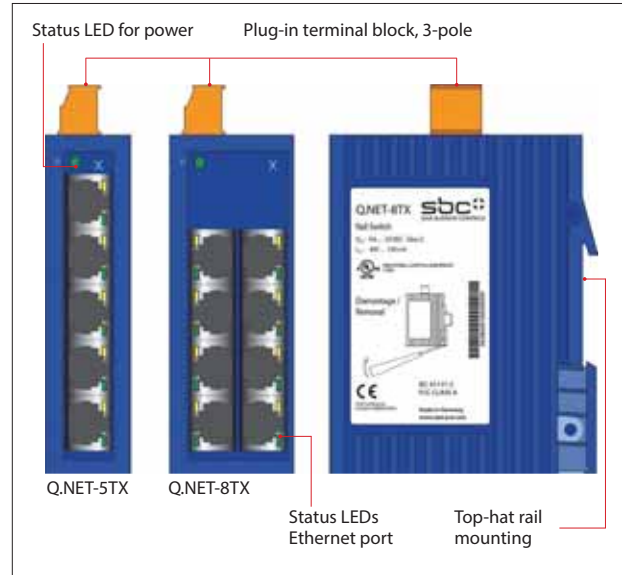

### Technical data Q.NET-5TX and Q.NET-8TX

<b>Operation</b>	
Port type and number	Ethernet 10/100 MBit/s, 5× RJ 45 (Q.NET-5TX) or 8× RJ 45 (Q.NET-8TX)
Network line lengths	Twisted pair (TP), 0...100 m
Network cascade depth	Linear/star structure – any depth
Operating voltage	9.6 VDC ... 32.0 VDC
Current draw at 24 VDC	max. 100 mA
Displays/diagnostics	1× green LED; power 5× / 8× yellow LED; data rate 5× / 8× green LED; data, link status
<b>Environmental conditions</b>	
Operating temperature	0°C to +60°C
Storage temperature	-40°C to +70°C
Humidity	max. 95 %, non-condensing
<b>Standards/approvals</b>	
EMC protection:	EN61000-4
EMC protection:	EN55022 Class A, FCC CFR47 Part 15 Class A
Security for Industrial Control Equipment	cUL508, CSA22.2 No. 142, E175531
Mechanical stability	IEC60068-2 (shock, vibration)
Protection type	
<b>Ordering information</b>	
Q.NET-5TX	5-port rail switch, terminal block, patch cable and operating instructions
Q.NET-8TX	8-port rail switch, terminal block, patch cable and operating instructions

### Dimensions

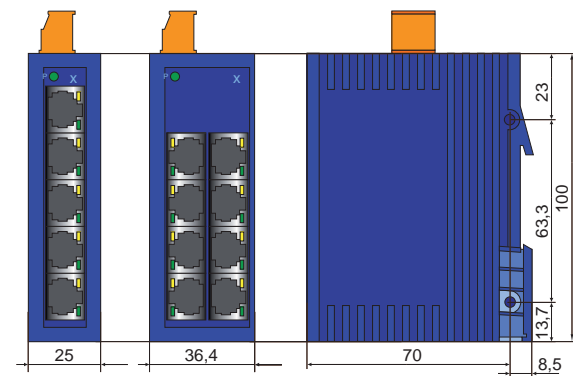

### Connection options

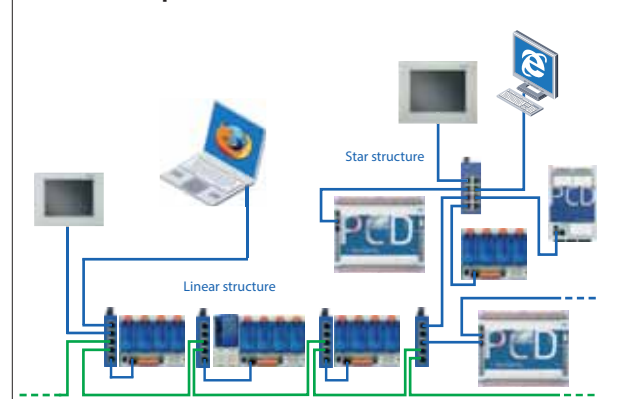

## 5.3 SBC RS-485 bus termination box PCD7.T16x

The PCD7.T16x termination boxes are used for RS-485 network termination. Each RS-485 network segment must be terminated at the end of the network. The PCD7.T16x termination boxes ensure that the RS-485 signals are set at the correct signal level and the integrated 120 Ohm resistor prevents signal reflection in the RS-485 cable. With their robust and compact construction, as well as the electrically isolated power supply with either 230 VAC or 24 VAC/DC, the PCD7.T16x termination boxes are suitable for use in rugged industrial environments and in infrastructure automation.

An LED indicates the presence of the supply voltage of the PCD7.T16x termination box.

### System properties

- ▶ 35 mm top-hat rail mounting
- ▶ 17.5 mm wide housing
- ▶ 230 VAC +15% /-20% for PCD7.T161
- ▶ 24 VAC / DC -15% /+15% for PCD7.T162
- ▶ Current consumption of 0.4 W
- ▶ Electrically isolated power supply
- ▶ Fixed line termination resistance of 120 Ω
- ▶ LED operating indicator

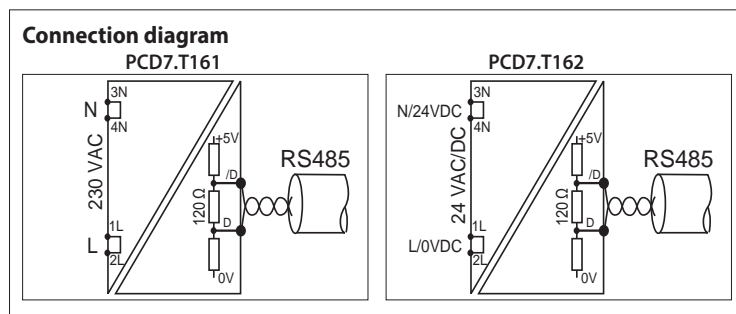

### Dimensions

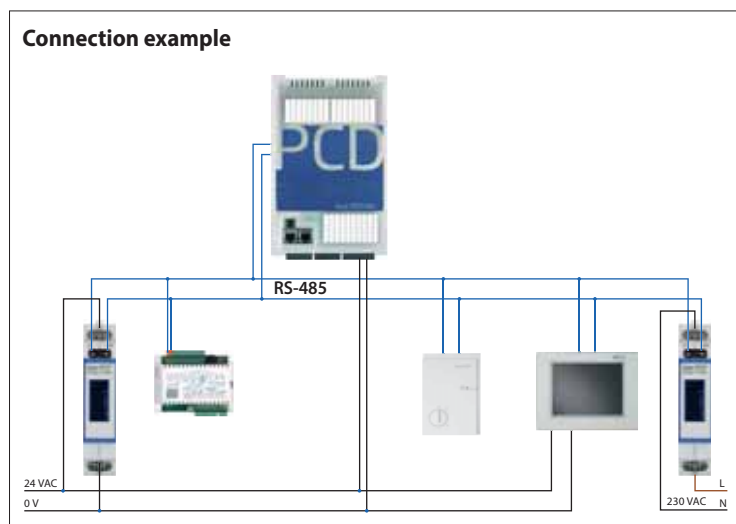
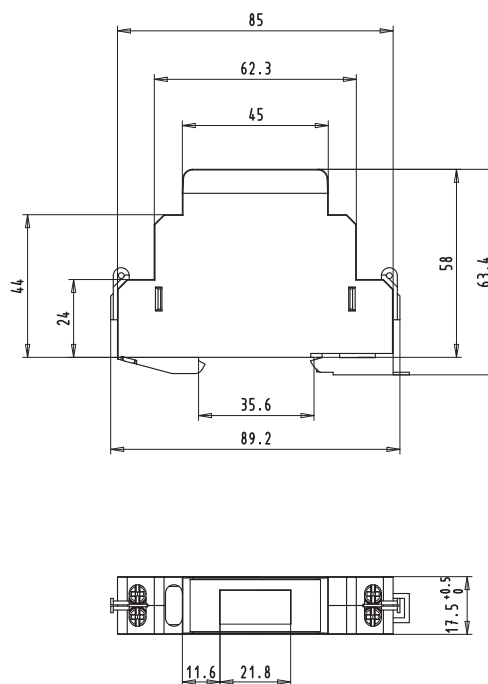

	PCD7.T161	PCD7.T162	Comments
Power supply	230 VAC	24 VAC / DC	
Housing	17.5 × 85 × 64 mm	17.5 × 85 × 64 mm	PCD7.T161 and PCD7.T162 comply with the standards for switch cabinets
Line termination resistance	Fixed 120 Ω	Fixed 120 Ω	
Display	LED for 230 VAC	LED for 24 V	
Lead-sealing cap as an accessory, see section 4.3.6 (ALD1)			

## 5.4 SBC isolating amplifiers DC/DC KFD1x

The SBC isolating amplifiers KFD1x isolate individual analog channels not only from input to output, but also from the supply and from frame ground potential. This electrical separation is particularly recommended for long lines in large installations. However, the SBC KFD1 can also be used to amplify a weak signal and convert it into a noise-proof current signal.

### System properties

- ▶ Available in two versions with different input ranges
- ▶ Conversion time 20 ms
- ▶ 0.5% accuracy at full scale
- ▶ Output electrically isolated from input with optical isolating amplifier



### Technical data for isolating amplifiers DC/DC KFD11 and KFD12

<b>Input ranges <sup>1)</sup></b> <b>KFD11</b>	0...10 VDC, input impedance 200 k $\Omega$ or 0...20 mA, load 47 $\Omega$ <sup>2)</sup>
<b>KFD12</b>	0...75 VDC, input current 0...20 mA or 0...60 mV, input current 0...60 $\mu$ A <sup>3)</sup>
<b>Output ranges <sup>1)</sup></b>	0...10 VDC, load ( $\geq$ 3 k $\Omega$ ); 0...20 mA, load ( $\leq$ 500 $\Omega$ )
<b>Input/output</b>	electrically isolated with optical isolating amplifier
<b>Conversion time</b>	20ms
<b>Short-circuit proof:</b>	yes, 1 minute, fault current <100 mA
<b>Status display</b>	LED green: supply voltage present
<b>Isolating characteristics</b>	800 VDC between supply, input and output
<b>Accuracy</b>	0.5% of final value
<b>Supply voltage</b>	19...70 VDC or 24 V $\pm$ 20% full-wave rectified
<b>Power consumption</b>	1.0...2.4 W depending on voltage and load
<b>Duty cycle</b>	100%
<b>Terminals</b>	screw terminals for 1 $\times$ 0.5 mm <sup>2</sup> to 2 $\times$ 2.5 mm <sup>2</sup>
<b>Mounting</b>	surface mounting; snap-on mounting onto top-hat rail according to DIN EN60715 TH35 (formerly DIN EN50022) (1 $\times$ 35mm) or screw fixing by adapter (accessory) and 2 screws M4
<b>Ambient temperature</b>	
<b>Operation</b>	0...50 $^{\circ}$ C
<b>Storage</b>	-25...+70 $^{\circ}$ C
<b>Humidity</b>	95% RH with no condensation
<b>EMC/interference immunity</b>	EN61000-4-4 (2 kV) at input and output EN61000-4-4 (4 kV) at supply
<b>EMC/emissions</b>	EN55022, class B

<sup>1)</sup> 2 input ranges/2 output ranges selectable with 2 slide switches on front panel  
<sup>2)</sup> Overvoltage protection by stress limiter, 27 V max.  
<sup>3)</sup> Overcurrent or overvoltage protection by stress limiter

### Dimensions

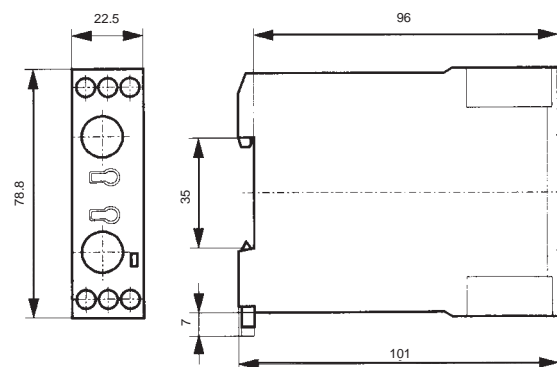

### Block diagram

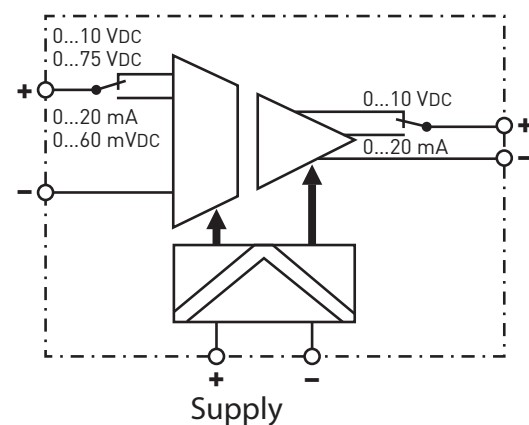

### Ordering information Isolating amplifiers DC/DC KFD11 and KFD12

<b>KFD11JVTN</b>	Isolating amplifier DC/DC with input and output ranges 0...10 VDC or 0...20 mA
<b>KFD12JVTN</b>	Isolating amplifier DC/DC with input ranges 0...75 VDC or 0...60 mV and output ranges 0...10 VDC or 0...20 mA



## 5.5 Coupler modules with manual operation to control drives, valves or flap systems

**PCD7.L252:** Changeover switch with manual control level Auto/OFF/ON

**PCD7.L452:** Analog value transmitter for manual correcting variables

**PCD7.L260:** Coupler module for two-stage motor control

### Dimensions

PCD7.L252/452

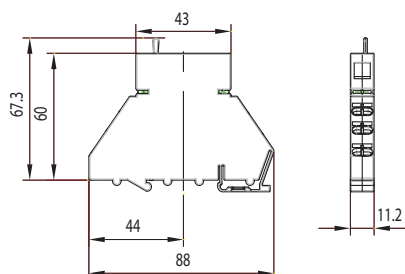

PCD7.L260

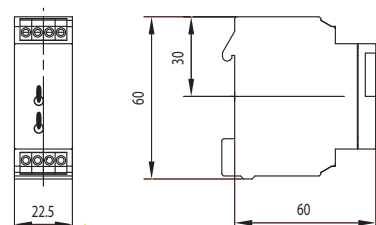

- ▶ 1 changeover switch
- ▶ Local override operation
- ▶ Auto acknowledge
- ▶ LED indicator
- ▶ 11.2 mm overall width
- ▶ Spring terminals

- ▶ Potentiometer 0...10 V
- ▶ Local override operation
- ▶ Auto acknowledge
- ▶ LED indicator
- ▶ 11.2 mm overall width
- ▶ Spring terminals

- ▶ Interlocked relay
- ▶ Local override operation
- ▶ Auto acknowledge
- ▶ LED indicator
- ▶ 22.5 mm overall width
- ▶ Screw terminals

Single-stage coupler component with local override operation, acknowledgement of switch position and an LED for status indication.

Spring terminals allow for quick and easy wire connection. Thanks to additional terminals, the supply voltage can be connected across jumpers without any wiring effort and additional time being involved.

The analog data encoder has three operating modes: ON, OFF and AUTO. In switch position AUTO, the control variable will be looped unchanged via the YR terminal to the control variable output Y. In switch position ON, the control variable can be set using the potentiometer on the front of the device. The output signal will be available at terminal Y.

When switching back from stage 2 to stage 1, stage 2 is switched off first and, after a <60 ms delay, stage 1 is switched on. A manual control level has been integrated for service purposes. The time function is operational here too.

### Input side

	PCD7.L252	PCD7.L452	PCD7.L260
Supply voltage	24 VDC/VAC, -15%/+10 %	24 VDC/VAC, -15%/+20 %	24 VDC/VAC, ±10 %
Current draw	13 mA, protection wiring with recovery diode	19 mA at 24 VDC 30 mA at 24 VAC	30 mA
Input current	---	2 mA at 10 VDC (input YR)	max. 4 mA, terminal B1/B2
Response / release time	10 ms/5 ms	---/---	20 ms/20 ms
Input voltage	24 VDC/VAC	0...10 VDC	24 VDC/VAC
Operating indicator	Green LED to indicate relay state	Red LED (brightness in proportion to control variable)	Two red LEDs to indicate relay state
<b>Output side</b>			
Output contact	1 changeover	---	1 changeover with 0 position
Turn-on voltage	max. 250 VDC/VAC	---	max. 250 VDC/VAC
On / off switching current	max. 8 A	---/---	max. 6 A
Output voltage	---	0...10 VDC, max. 10 mA, output Y in switch position Auto/ON	---
Constant current	8 A	---	4 A
Breaking capacity (ohmic load)	24 VDC/180 W 50 VDC/65 W 230 VDC/50 W 250 VAC/2000 VA	---	24 VDC/150 W 50 VDC/25 W 230 VDC/50 W 230 VAC/1500 VA
Breaking capacity min.	24 VDC/20 mA	---	24 VDC/20 mA
Service life mechanical	2 × 10 <sup>7</sup> switch cycles	---	1 × 10 <sup>7</sup> switch cycles
Service life electrical (at maximum switching load)	1 × 10 <sup>5</sup> hystereses	---	1 × 10 <sup>5</sup> hystereses
Switching frequency	max. 300 hystereses / h at max. current	---	max. 1,200 hystereses / h at max. current

### Accessories

PCD7.L291	Jumper for connection of the supply voltage of up to 10 PCD7.L252 and PCD7.L452 modules
PCD7.L490	Labeling plate for PCD7.L452 (in packs of 10)
PCD7.L290	Labeling plate for PCD7.L252 (in packs of 10)









PCD7.L291



PCD7.L490 / PCD7.L290

## 5.6 SBC timer delay relays

KOL2 and KOL3	KOP.J	KOP.K			
<ul style="list-style-type: none"> <li>▶ Multi function or mono function</li> <li>▶ 4 time ranges (KOL 251)</li> <li>▶ 6 time ranges (KOL 3)</li> <li>▶ 17.5 mm width for DIN rail</li> <li>▶ 24...48 VDC and 24...240 VAC</li> <li>▶ 2 make contacts (KOL 251)</li> <li>▶ 1 changeover contact (KOL 3)</li> </ul>	<ul style="list-style-type: none"> <li>▶ Multi function or mono function</li> <li>▶ 10 time ranges</li> <li>▶ 22.5 mm width for DIN rail</li> <li>▶ 24...48 VDC and 24...240 VAC</li> <li>▶ 1 changeover contact</li> </ul>	<ul style="list-style-type: none"> <li>▶ Multi function or mono function</li> <li>▶ Up to 10 time ranges</li> <li>▶ 22.5 mm width for DIN rail</li> <li>▶ 24...48 VDC and 24...240 VAC, 50/60 Hz</li> <li>▶ 24...240 VAC/DC</li> <li>▶ 1 or 2 changeover contacts, instantaneous and/or timed contacts</li> </ul>			
					
KOL251H...	KOL360H...	KOP160J...	KOP170J...	KOP219K...	KOP560K...

### Dimensions

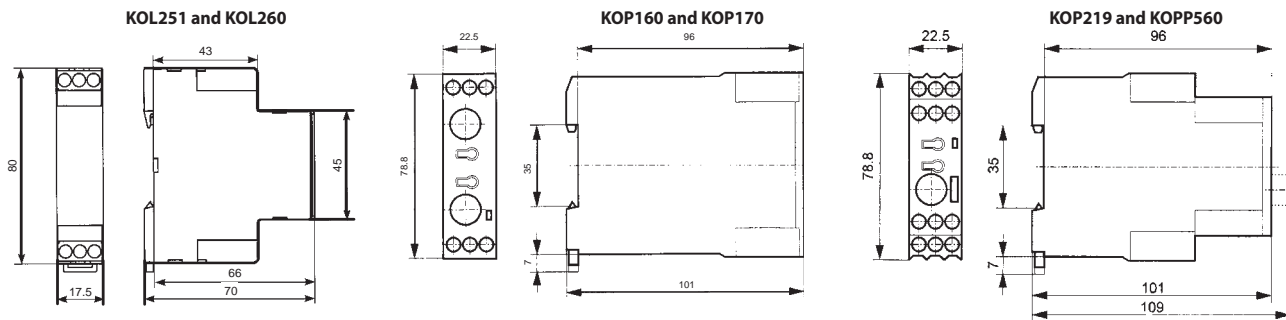

Series	KOL2	KOL3xxH...	KOP1xx.J...	KOPxxx.K...		
Order reference	KOL251H7MKVVPN00	KOL360H7MRVVPN00	KOP160J7MWVVPN00	KOP170J7MWVVPN00	KOP219K7MWVAN00	KOP560K7MWVVPN00
<b>Functions</b>						
Delayed operation	---	•	•	---	---	•
Delayed release	---	•	•	---	---	•
Delayed release after failure of operating voltage	---	---	---	---	•	---
Delayed operation and release	---	---	•	---	---	•
Fleeting-on delay timer	---	•	•	---	---	•
Fleeting-off delay timer	---	---	•	---	---	•
Flasher relay	---	•	---	---	---	---
Star-delta timer	•	---	---	---	---	---
Pulse converter	---	---	•	---	---	•
Pulse generator	---	---	•	---	---	•
Flasher relay with pulse starting	---	---	•	---	---	•
Asymmetrical pulse generator	---	---	---	•	---	---
On/off function for startup and maintenance	---	---	•	---	---	•
<b>Time ranges</b>						
0.15 s...10 min	•	---	---	---	•	---
0.05 s...10 h	---	•	---	---	---	---
0.05 s...60 h	---	---	•	•	---	•
<b>Operating voltage</b>						
24...48 VDC and 24...240 VAC	•	•	•	•	---	•
24...240 VDC or 24...240 VAC	---	---	---	---	•	---
<b>Contacts</b>						
2 make contacts with a joint connection	•	---	---	---	---	---
1 changeover	---	•	•	•	---	---
2 changeovers	---	---	---	---	•	---
2 changeovers, instantaneous and/or timed contacts	---	---	---	---	---	•

## 5.7 SBC Monitoring relays

### KFE102 / 103 / 300 / 302

- ▶ Voltage and current monitoring, three-phase asymmetry monitoring
- ▶ Phase order, phase failure
- ▶ Three-phase voltage monitoring
- ▶ 230 VAC, 3 × 400 VAC 50/60 Hz
- ▶ 1 changeover contact

### KFT100 / 200

- ▶ Motor monitoring by PTC
- ▶ PTC short-circuit monitoring
- ▶ PTC cable-break monitoring with memory function (KFT200)
- ▶ 230 VAC
- ▶ 1 relay (NO contact, KFT100)
- ▶ 2 relays (changeover contact, KFT200)



KFE102

KFE300

KFE302



KFT100

KFT200

### Dimensions

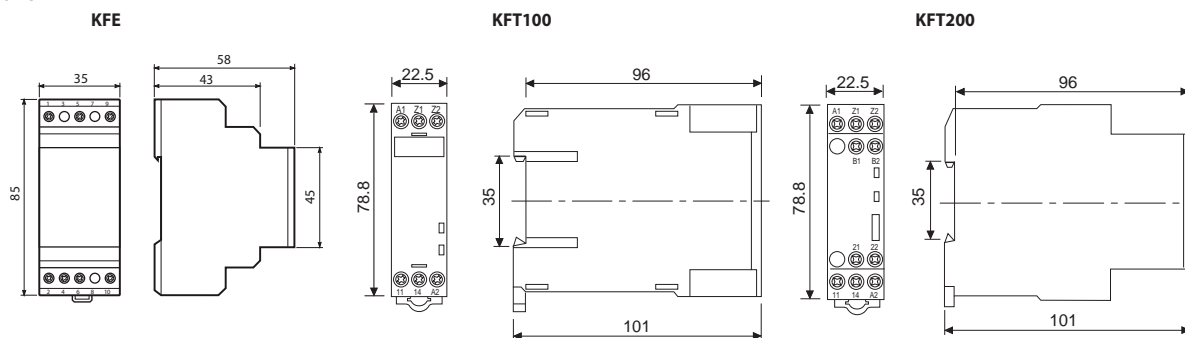

Series	KFE102/103/300/302				KFT100/200		
	Order reference	KFE102NE1N	KFE103NE1N	KFE300NE9N	KFE302NE9N	KFT100JE1N	KFT200KE1N
<b>Functions KFE102/103/300/302</b>							
Voltage monitoring	•	•	•	•	•	•	•
Current monitoring	---	---	---	---	---	---	---
Monitors phase loss, order, asymmetry and under voltage	---	---	•	---	---	---	---
3-phase voltage monitoring (AC)	---	---	---	•	---	---	---
Memory function	•	•	---	•	---	---	---
<b>Settings KFE102/103/300/302</b>							
Parameterizable, LCD display	•	•	---	---	---	---	---
Analog	---	---	•	•	---	---	---
<b>Functions KFT100/200</b>							
Motor monitoring by PTC	---	---	---	---	•	•	•
Short-circuit monitoring in the PTC measuring circuit	---	---	---	---	•	•	•
Cable-break monitoring in the PTC measuring circuit	---	---	---	---	•	•	•
Memory function	---	---	---	---	---	•	•
<b>Reset KFT100/200</b>							
automatic	---	---	---	---	•	---	---
manual or automatic	---	---	---	---	---	•	•
<b>Operating voltage</b>							
230 VAC	•	•	---	---	•	•	•
3 × 400 VAC	---	---	•	•	---	---	---
<b>Output</b>							
1 relay (NO contact)	---	---	---	---	•	---	---
1 relay (changeover contact)	•	•	•	•	---	---	---
2 relays (changeover contact)	---	---	---	---	---	•	•
<b>Function control</b>							
LED display	•	•	•	•	•	•	•



# B

## Basic systems

<b>B1</b>	SBC Software	145
<b>B2</b>	Communication & Interaction	189
<b>B3</b>	SBC S-Web	223





# B1

## SBC Software

The Saia PG5® Controls Suite contains everything required to implement and operate automation solutions with Saia PCD® instrumentation, control and automation (ICA) devices.

This includes programming and engineering tools as well as libraries and ready-made logic, regulation and automation modules. It also contains application software for Windows PCs.

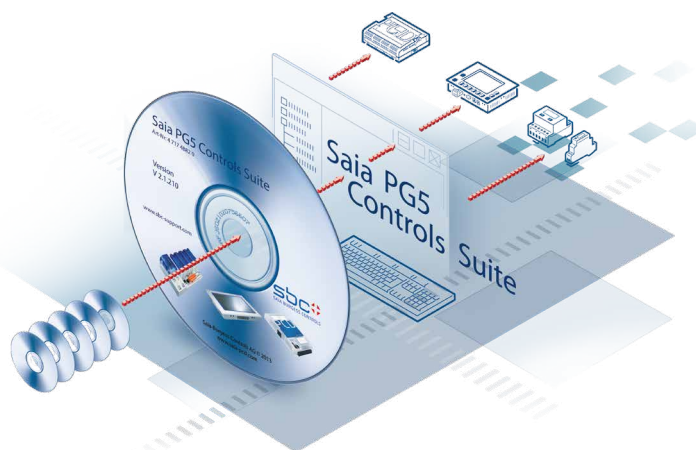

### 1.1 Saia PG5® Controls Suite: Engineering & programming Page 146

- |         |   |          |
|---------|---|----------|
| 1.1.1   | <b>Saia PG5® Core – everything you need available at all times</b>  | Page 146 |
| 1.1.1.1 | <b>Saia PG5® Core   Basic properties</b><br>Functions and areas of use of the Saia PG5® Core.<br>What is the license policy and how does software maintenance work (e.g. updates)?  | Page 146 |
| 1.1.1.2 | <b>Saia PG5® Core   Components</b><br>Presentation of the individual components and overview of the Saia PG5® Core.   | Page 150 |
| 1.1.1.3 | <b>Saia PG5® Core   Example application</b><br>The Saia PG5® Core is presented using a simple logic.<br>All the basic functions of the Saia PCD® Automation Server can be used.   | Page 160 |
| 1.1.2   | <b>Saia PG5® HVAC modules and use</b>   |          |
| 1.1.2.1 | <b>HVAC modules</b><br>Engineering the technical systems of buildings is made simpler by the HVAC library.  | Page 164 |
| 1.1.2.2 | <b>Example application of the HVAC library</b><br>Programming a ventilation system in individual steps.   | Page 165 |
| 1.1.3   | <b>Increasing engineering efficiency through installation templates</b>   |          |
| 1.1.3.1 | <b>DDC Suite</b><br>Shorten the engineering time with the DDC Suite and web templates.  | Page 169 |
| 1.1.3.2 | <b>Example application of DDC Suite</b><br>The benefit of the DDC Suite from an engineering point of view is shown in the example.  | Page 173 |
| 1.1.4   | <b>Saia PG5® Controls Suite</b>   |          |
| 1.1.4.1 | <b>My Controls Suite</b><br>Create your own templates or FBoxes using the Saia PG5® FBox Builder for a perfect fit to your applications and your workflow.  | Page 174 |
| 1.1.4.2 | <b>Web Editor as a stand-alone tool</b><br>The Web Editor is integrated into the Saia PG5® Core but can also be used as a stand-alone tool.   | Page 176 |
| 1.1.4.3 | <b>Overview of the tools and license packages</b><br>Better understanding and overview of the engineering and programming tools.<br>Of the wide variety of software combinations, 3 packages are defined for the global standard. | Page 178 |

### 1.2 Application software for Windows PCs Page 180

- |       |  |          |
|-------|--|----------|
| 1.2.1 | <b>Saia Visi.Plus   Classic control/management system</b><br>For the optimization of complex, distributed systems and properties with a large number of Saia PCD® automation stations. | Page 180 |
| 1.2.2 | <b>SBC.Net Suite</b><br>Link between automation technology with the Saia PCD® System and Windows applications.   | Page 186 |
| 1.2.3 | <b>SBC OPC Server</b><br>Industrial bus systems and protocols provide a universal communication possibility.   | Page 187 |

# 1.1 Saia PG5® Controls Suite: Engineering & programming

## 1.1.1 Saia PG5® Core – everything you need available at all times

The Saia PG5® Core is a central key element of the Saia PG5® Controls Suite. This is used to create Saia PCD® projects. The Saia PG5® Core is included in every software package and is identical throughout.

### 1.1.1.1 Saia PG5® Core | Basic properties

#### ► Wide range with large projects and high complexity

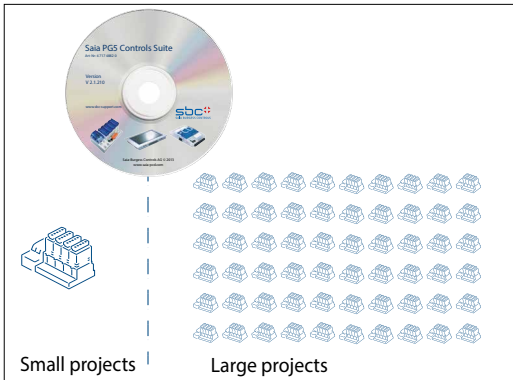

With the Saia PG5® Project Manager, projects can be managed with just one individual controller or with very large networks. It is used at OEM manufacturers with just one Saia PCD® per machine, and equally well in large properties such as tunnels with over a thousand installed Saia PCD® controllers.

◀ The Saia PG5® Project Manager for individual devices just as for large control networks.

#### ► Software tool with broad user profile – everyone can get used to it quickly

Saia PG5® Core offers all groups of people involved in ICA and automation technology suitable functions for mastering their tasks reliably and well.

As an application engineering tool, users can also implement the most demanding automation projects using graphical application modules in the Fupla Editor without them having to program in IL, Graftec or Kopla, etc.

As a development tool, dedicated control and logic functions, communication drivers and IT functions can be programmed in the Instructions List.

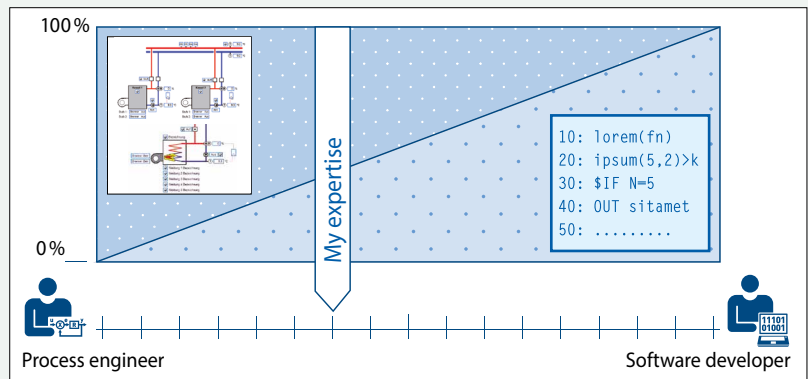

▲ Saia PG5® offers a large variety of solutions – there is one to suit everyone

#### SBC training program 1+3+3

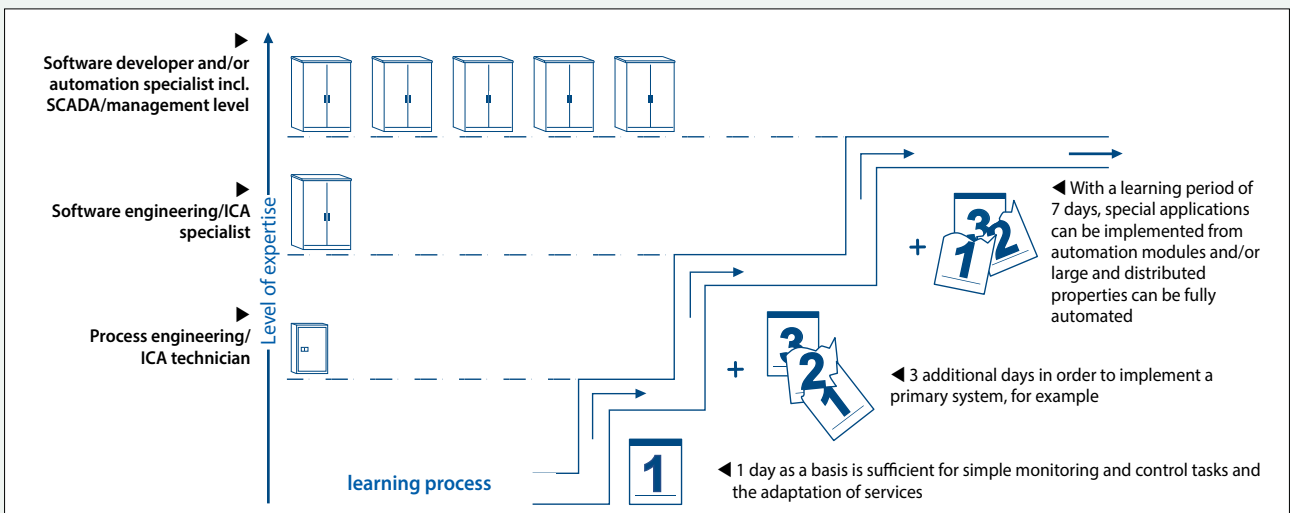

▲ The time up to which solution competence is achieved

► A standard software – for all device types – now and in the future

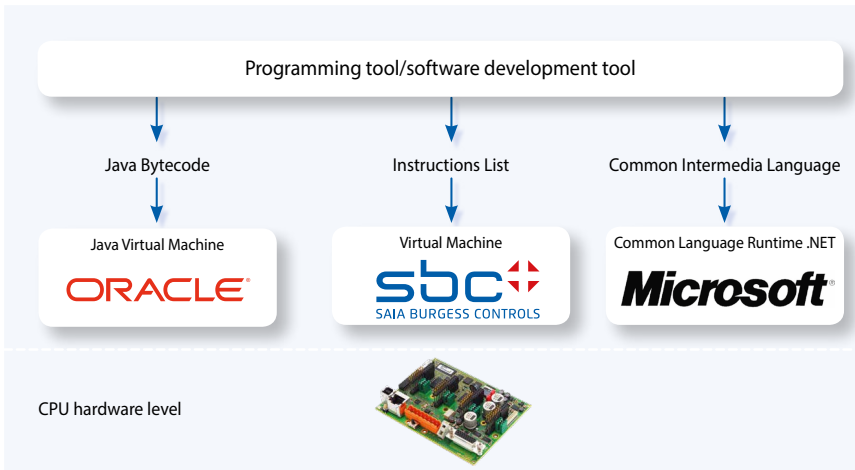

▲ We supply our devices with a virtual ICA machine. This “machine” always remains the same even if the hardware on it changes. Your application will always run on all device platforms – now and in the future.

Applications can be ported over long periods of time and across all product lines. Virtualization is the key to reusable program code. Java and Microsoft.Net work in the same way. Hardware-dependent compilation of applications, e.g. as is normal for soft PLC systems, is obsolete.

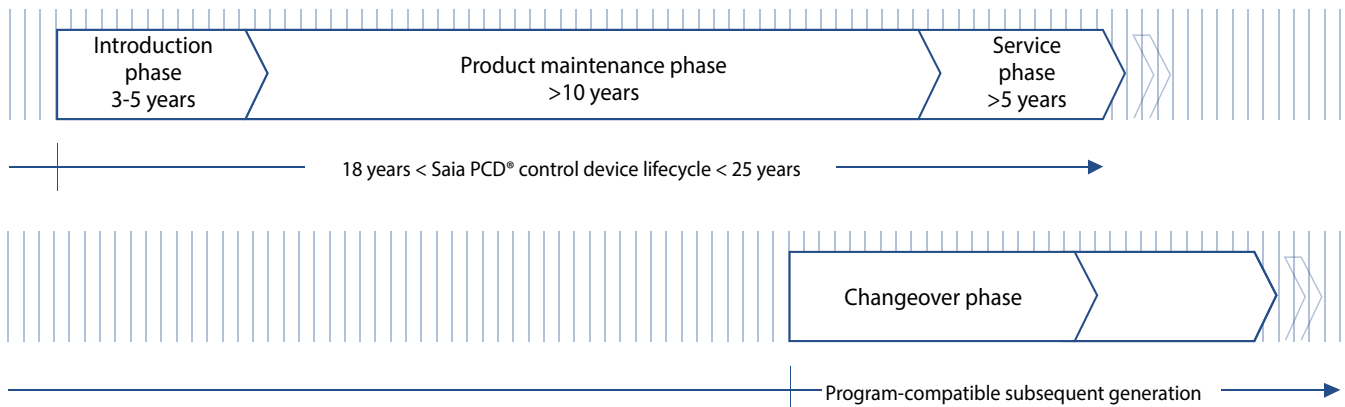

▲ Lifecycle planning of Saia PCD® control devices. Enables maximum profitability of your investment in know-how and systems. Long usage phase without expensive reinvestment and no high service costs.

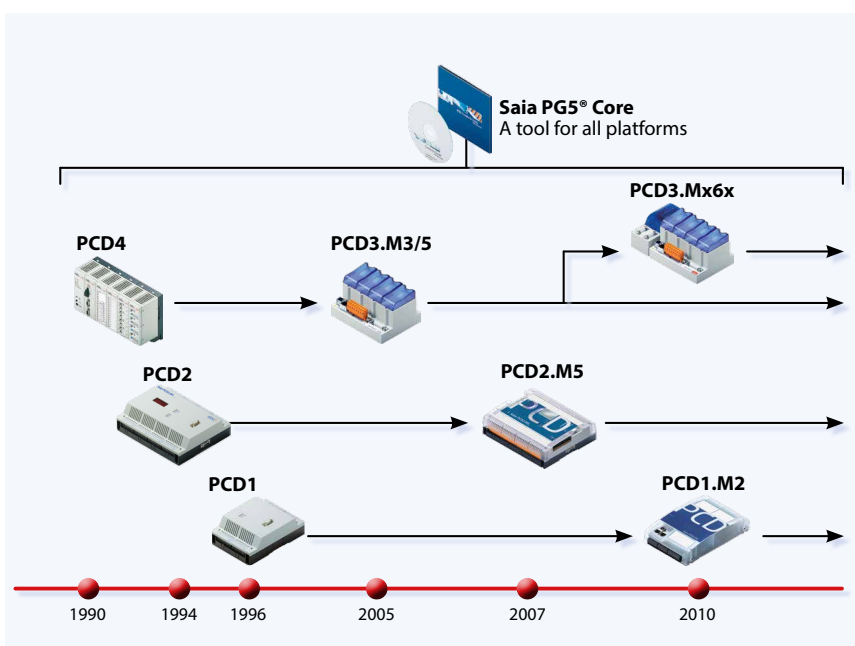

▲ Old application programs can be taken over for new Saia PCD® controllers and further processed with the Saia PG5® Core

The control electronics should have the same lifecycle as the systems technology. It must be possible to adapt and extend at any point in this cycle. The compatibility and free portability of systems/machine software is ensured by an overall product generation of 18-25 years. This only works if engineering software is developed fully in-house and thus relies on “interpreted program code”. This requires more hardware resources but enables the portability of user software across multiple generations of controllers.



## License policy for maximum security, flexibility and independence

- ▶ In principle, any company can apply for the Saia PG5® license. There are no market-related exclusions as with other providers. The only requirement is the ability to use the products professionally.
- ▶ With the acquisition of a Saia PG5® license, a company can register any number of its employees as users. There are no costs per space or per user. However, a company must at least have one proven qualified Saia PG5® programmer. The qualification can be obtained via training by SBC.
- ▶ There is a special end user license for operators of Saia PCD® automation systems. This includes all SBC software tools and SBC application libraries which an external service provider or OEM has used in a system/property to create an automation system. The end user license only applies to the Saia PCD® devices installed at the operator and cannot be used for the creation of automation solutions for third parties.

◀ This certification as a Saia PCD® system integrator shows that a company has proven its ability to implement automation solutions reliably and professionally with Saia PCD®. We recommend that operators, investors and planners take into account the certification when selecting the service provider.



Saia PG5® Controls Suite test license

**90-day test license:** All Saia PG5® Controls Suite components can be tested for 90 days free of charge. There are no functional limitations and all the applications developed during the trial period can be used 1:1 in the licensed version.



Make sure that your systems are created with the correct licenses in order to guarantee the warranty and support as well.

USER · KEY  
KEY-Datei  
1KB



License as a "user key"

## Licensing procedures

The Saia PG5® license mechanism offers better flexibility and more simplicity when installing license extensions. The license is distributed as a "user key" file which defines the user permissions for the software applications. A license extension can be quickly distributed by sending the customer an e-mail with a "user key" file or a password.

SBC can create customer-specific user keys using the license manager.

The keys can be tailored to any request. It is possible to define the editors or libraries which the customer is permitted to use. The scope, number and size of the projects are irrelevant here.

### Software maintenance

We are continually further developing our software in sensible and easy-to-manage innovation steps. The following diagram shows the major version changes over the past 10 years. Known errors are dealt with via patches without a version change. New functions are first tested in beta versions before the sum of all new functions is made official in a major new version. A moderate fee is charged for major version steps with substantial additional functions. This occurs in a cycle of 2–3 years.

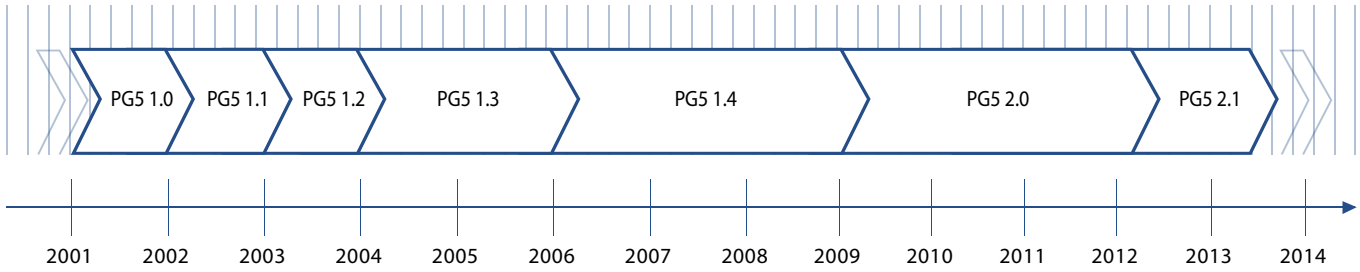

▲ Milestones in software development and maintenance

### 1.1.1.2 Saia PG5® Core | Components

On the following pages, the Saia PG5® Core is presented and the components are explained in more detail.

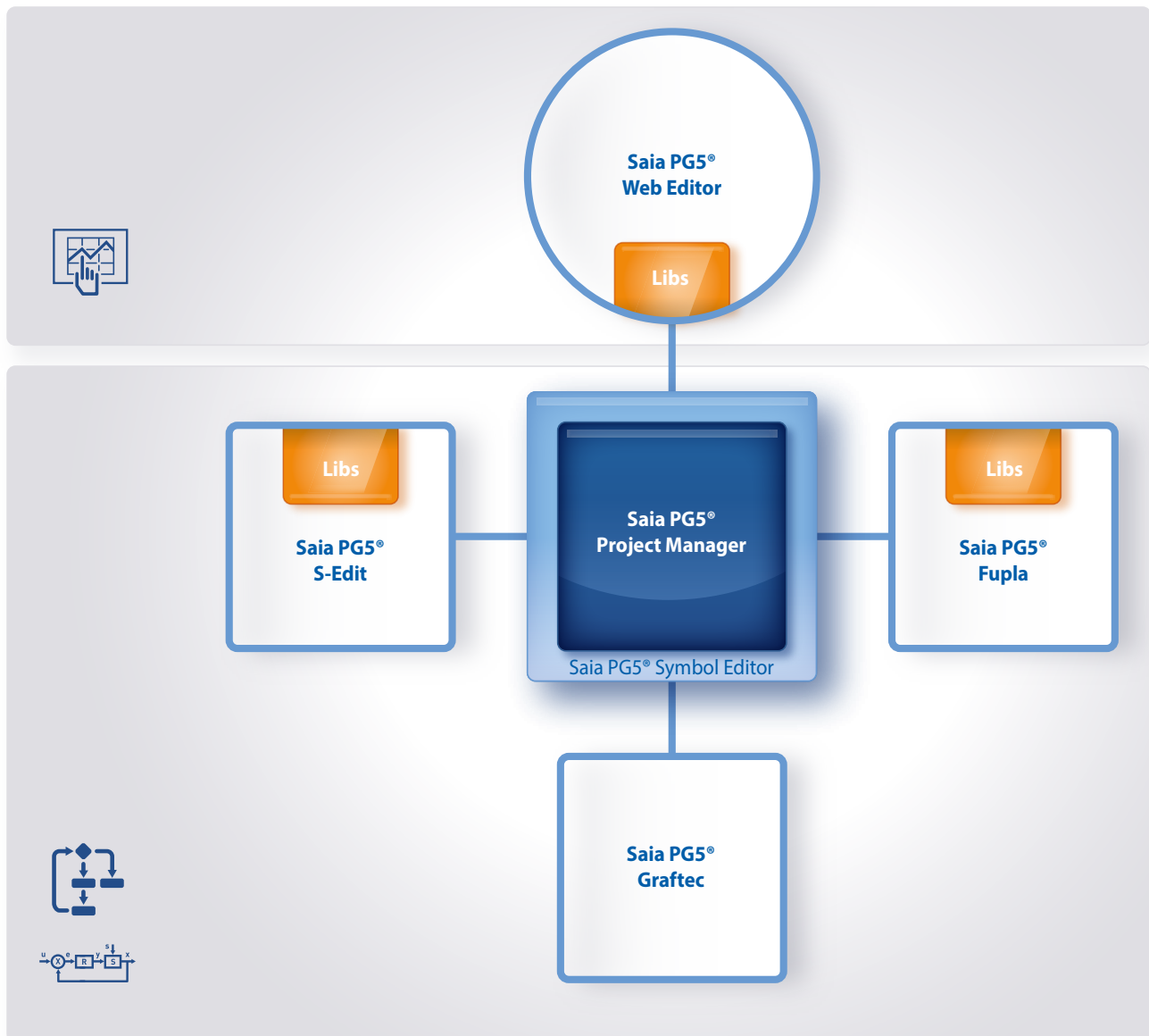

▲ Saia PG5® Core at a glance

#### The Saia PG5® Core contains the following components:

- ▶ Project Manager (administers complex installations of networked PCD controllers, including documentation)
  - ▶ Network Configurator (integrated network editors for the configuration of devices and communications networks)
  - ▶ Device Configurator (configuration of hardware parameters on the controller)
- ▶ Symbol Editor (administers all local, global and network symbols and symbol groups. Auto-allocation largely dispenses with the need for fixed addressing)
  - ▶ Programming methods (integrated programming environments: Fupla [function block diagram], S-Edit [instruction list IL] and Graftec [sequential function chart])
  - ▶ Libs (standard libraries which quickly and easily enable all the core functions of the ICA/automation technology)
  - ▶ Web Editor (for WebSCADA functions in every controller)



## Saia PG5® Project Manager

The configurations and applications are created, changed and managed in the Saia PG5® Project Manager. The Saia PG5® Project Manager is the central linchpin for all work with Saia PCD® controllers.

The following window appears on the left-hand side of the screen as soon as the Saia PG5® Project Manager is opened. Thanks to desktop docking, there is still enough space on the right-hand side of the screen for further windows.

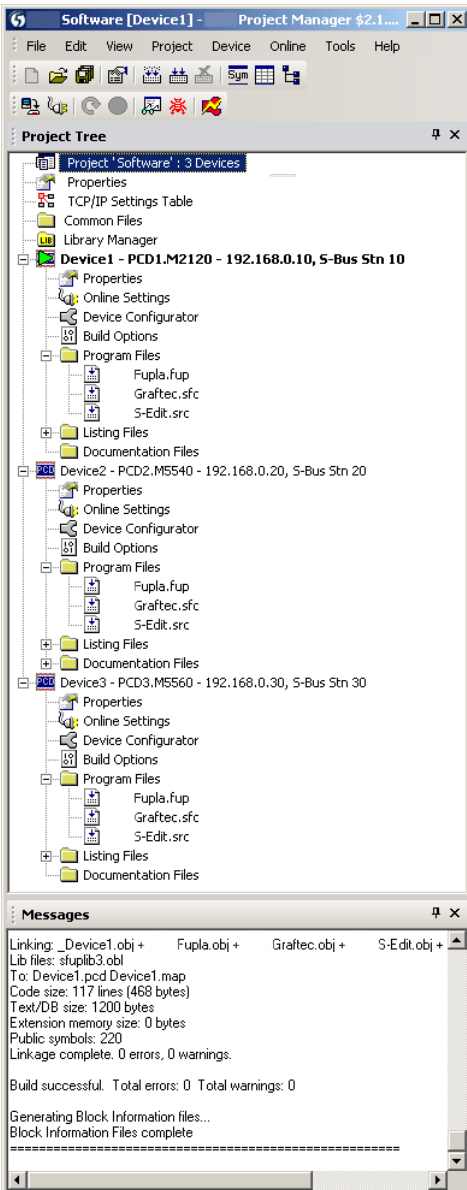

### Project Tree

The layout and structure largely correspond to Windows Explorer. The "Project Tree" window allows direct access to all PCDs used in the project, their settings and the program files and documents that go with them. Program organization by files (containing one or more program blocks) simplifies the shared use of program files in multiple Saia PCD®.

The "Program Files" folder may also comprise different data types. It is therefore possible to save all types of programming in one folder.

### Messages and Error List

Displays the build log, error and status messages. Errors in the program code are listed here after the build, and can be located directly by clicking.

Window of the Saia PG5® Project Manager

## Network Configuration

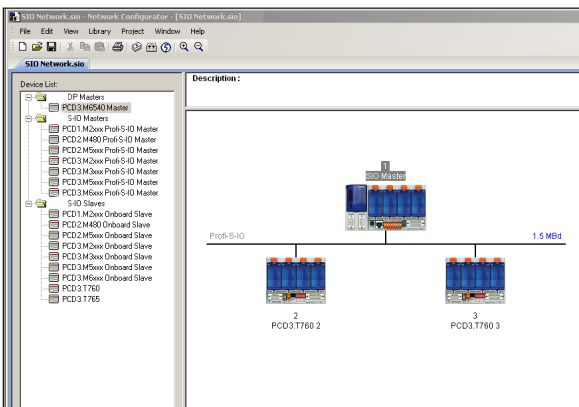

Network configurator in use – Profibus-DP Network

Network configuration is used for the configuration of devices and communications networks. Three different configurations generally exist:

### 1.) Ethernet RIO Network Configurator

- Smart RIO – PCD3.T665 and PCD3.T666.

### 2.) BACnet Network Configurator

- BACnet Configuration Files (\*.bnt)

### 3.) S-Net Network Configurator

- Profibus-DP Network File (\*.dp)
- Profibus-DP Network File (\*.sio)
- LON Network File (\*.lon)

## Device Configurator

The hardware and physical functions of the controller are defined in the Device Configurator; e.g. device type, memory modules, communication channels, associated modules and I/Os. The I/O configuration, parameterization and designation, as well as the configuration of the Ethernet protocols, e.g. DNS, DHCP etc., takes place here. The Device Configurator also controls the use of input/output modules in the internal power supply of PCDs and prints the labels which are adhered to the I/O modules.

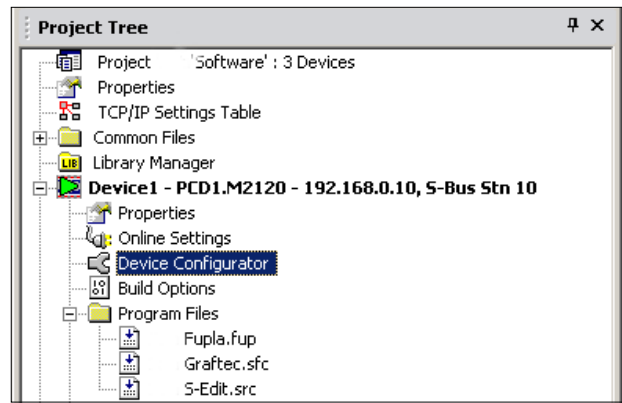

Selecting Device Configurator in the Saia PG5® Project Manager

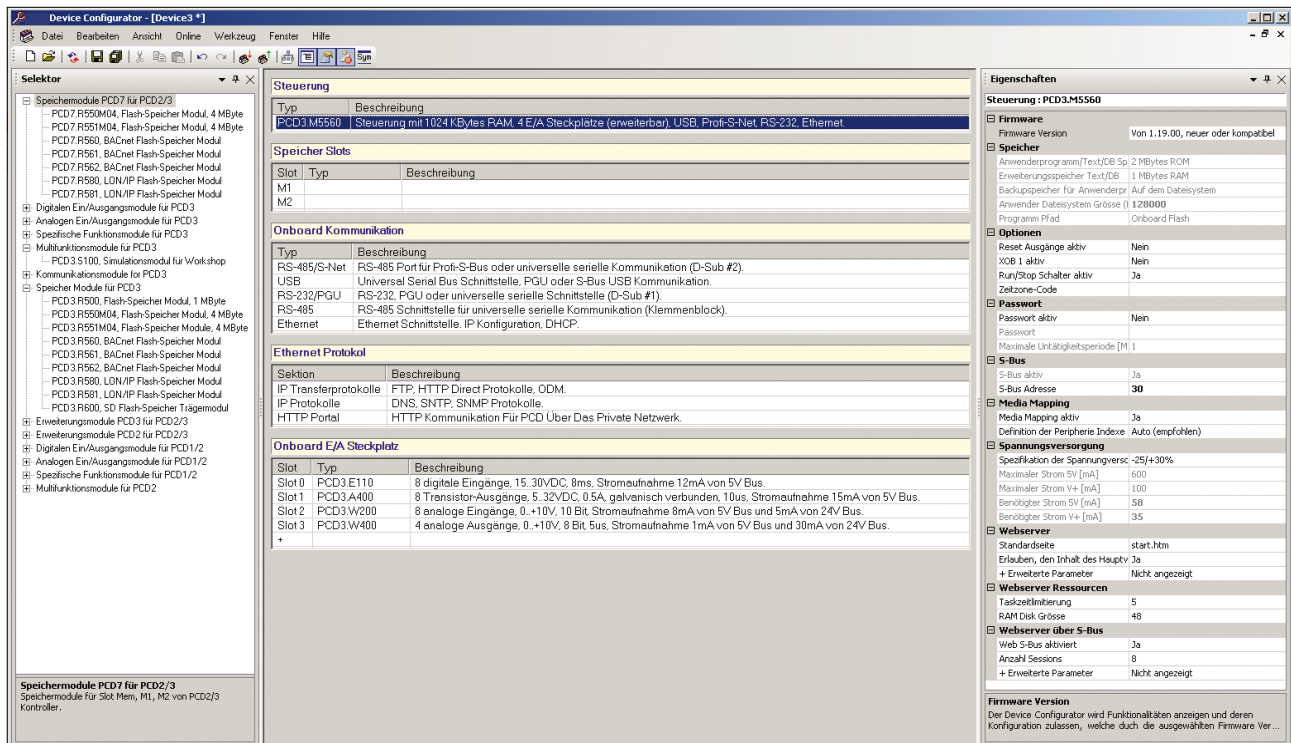

All parameters and modules can be viewed at a glance and printed out as system documentation in the Device Configurator.

## Symbol Editor

The Symbol Editor is the heart of the Saia PG5® Core. It defines and documents all symbols used by the program.

The various editors are connected by the Symbol Editor. New symbols used in the program code are taken over directly by the Symbol Editor.

► The import/export function allows the reuse of pre-defined I/O lists in electrical diagrams and visualization tools.

► Symbols can be grouped together. All the symbols required for a function form one group. This makes it easier to use functions and recognize symbols in the program code, and also gives a clearer overview in the Symbol Editor.

Symbol Name	Tag	Address/Value	Comment	Actual Address	Tag	Scope
ROBOT	GROUP					
Temp	GROUP					
→ Alarmwert	R	45	Wert aus der Analogeingangskarte	45		Public
→ Einwert	R	646	Physikalischer Wert	646		Public
→ Wert	GROUP					
→ Sollwert	R	→ 140	Sollwert Einstellung Wertebereich	2291		Public
→ Messung	F	23	Eingangsnormal	23		Public
Filter	GROUP					
→ Messung	F	463	Strommessung	463		Public
→ Eingang	F	45	Eingangsnormal	45		Public
Einfluss	GROUP					
→ Betriebszeit	R	→ 2	Vorwahl Betriebszeit (Datum: 14.01.20...)	2292		Public
→ Alarm	F	1	Strommessung	1		Public
→ Messung	F	2	Strommessung	2		Public
→ Messung	F	3	Strommessung	3		Public
→ Eingang	F	4	Eingangsnormal	4		Public
→ Rücklauf	GROUP					
→ Front	GROUP					
→ Verall	GROUP					
→ Signal	R	341	Unabhängig	341		Public
→ Anlaufzeit	F	45	Wertebereich	45		Public
→ Abfall	GROUP					
→ Zustand	GROUP					
→ Anzeige	GROUP					
→ Kontrolle	GROUP					
→ HILF	GROUP					
→ Hilfen	GROUP					
→ OSB_0	COB					Local

Overview of all symbols used in the Symbol Editor

### Programming methods in the Saia PG5® Core

#### Saia PG5® Fupla (function block diagram)

Fupla is SBC's own function block diagram editor. It differs in many respects from other graphical programming interfaces:

- ▶ One Fupla file can contain several program blocks. This means that one file can encompass an entire machine function. In symbolic programming, each program block is given an individual symbol name. This prevents collisions during the build.
- ▶ Fupla blocks are organized into pages. Each page can produce several outputs so that entire functions can be seen at a glance on one page.
- ▶ Graphical functions (FBoxes) not only have inputs and outputs, but also parameter windows for configuring and online modification.

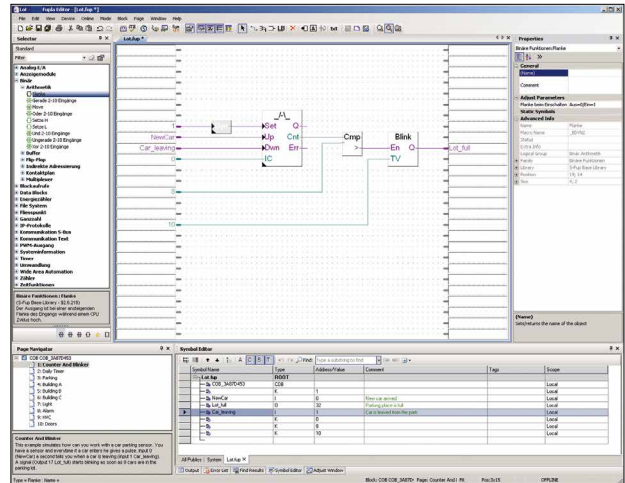

Saia PG5® Fupla (function block diagram)

**Comment:** The Kopla Editor (contact plan) is an integral part of the Saia PG5® Fupla Editor. Unlike conventional graphical programming environments, FBoxes and contact plan elements can be freely mixed in one and the same graphic.

#### Saia PG5® Graftec (sequential function chart)

Graftec (sequential function chart) is particularly suited to sequential processes. Sequential blocks are a fixed component of the PCD firmware and are processed by it efficiently.

- ▶ Steps and transitions can be programmed in IL and graphically in Fupla.
- ▶ In order to ensure a good overview with extensive sequential processes as well, the division into sub-pages is possible.
- ▶ In online mode, the active transition is permanently displayed.
- ▶ Option to process the code step-by-step in step mode.

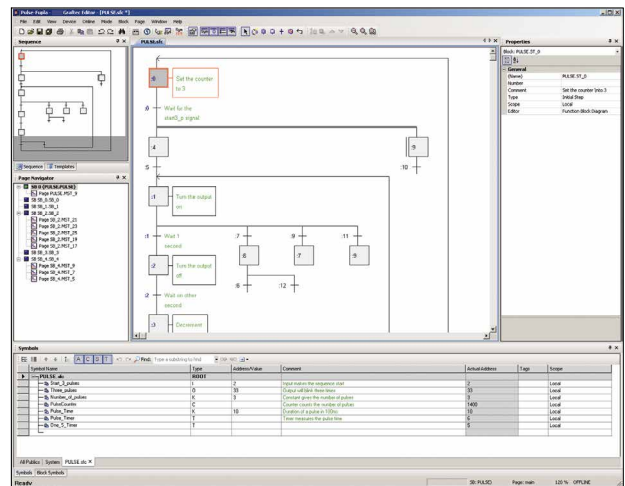

Saia PG5® Graftec (sequential function chart)

#### Saia PG5® S-Edit (instruction list IL)

The editor for the strong instruction set of Saia PCD®. S-Edit combines an editor and online debugger in one interface.

- ▶ The color syntax function detects valid instructions and applies a color to them. The program code is thus much easier to read and typographical errors are detected immediately.
- ▶ The "Bookmarks", "Goto Line", "Find and Replace" editor functions make it easier to navigate through extensive programs.
- ▶ The code built can be shown directly in the original code. The function is also used by the integrated debugger.
- ▶ Complete functions can be copied from the library using drag-and-drop.

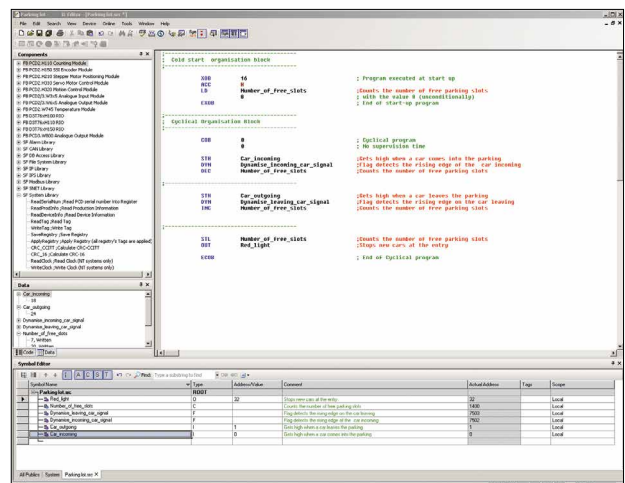

Saia PG5® S-Edit (instruction list IL)

## Saia PG5® Fupla

The Saia PG5® Fupla Editor is the quickest and most reliable method of implementing applications. This editor can also be easily used by those with no software programming experience. It is the right tool for optimizing and modifying systems. All complex functions have been implemented by specialists in Saia PG5® S-Edit or Saia PG5® Graftec and packaged into graphical function blocks (FBoxes). "Ready and simple to use" also by service technicians and process engineers.

In the automation of infrastructure, > 95% of all applications are implemented purely by engineering with Saia PG5® Fupla. Not one line of code is written here.

### Benefits of using the Fupla Editor

- ▶ Programming is made much easier with pre-programmed function blocks (FBoxes) for all standard functions
- ▶ Creation of complex user programs by simply positioning and linking function blocks. This does not require extensive programming knowledge.
- ▶ Extensive and high-performance FBox families for communication and building automation tasks
- ▶ Detailed context-sensitive FBox information, clear parameter descriptions and graphical presentation in the function block diagram editor (Fupla) make user programs easy to read and understand
- ▶ Online display of process values and parameter adjustment makes commissioning considerably easier and saves maintenance costs

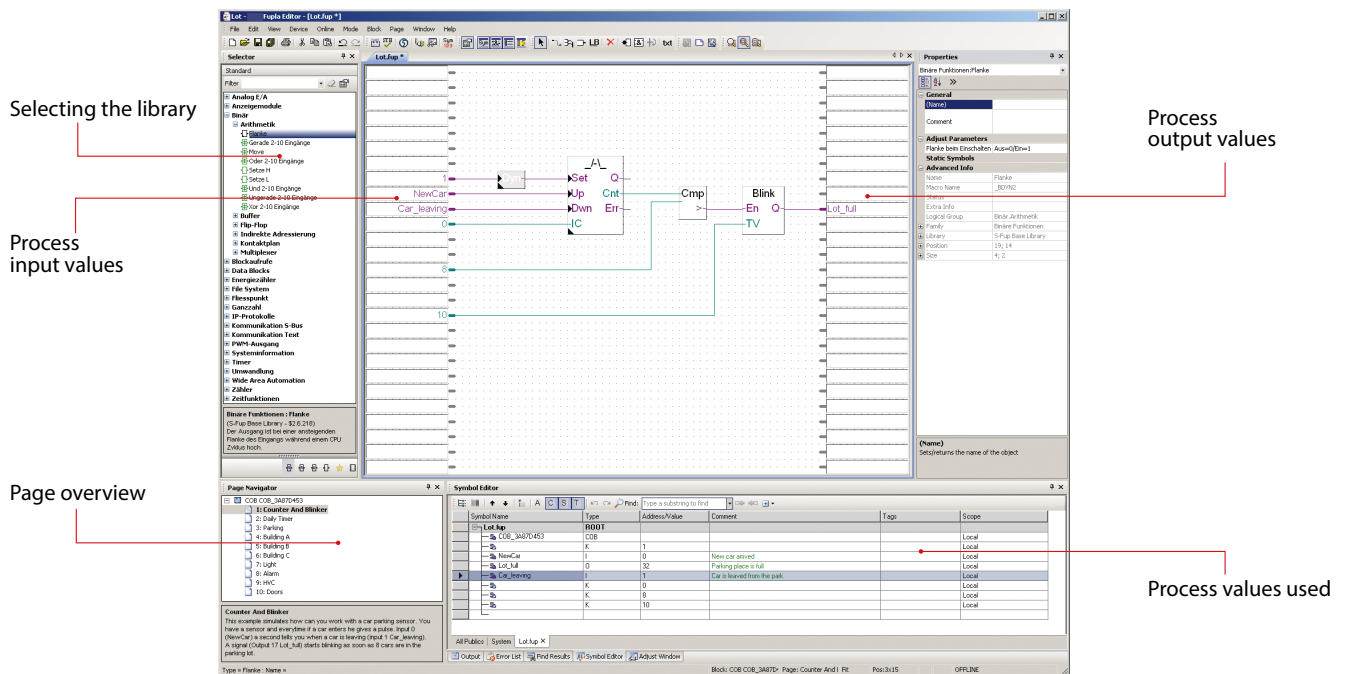

Structure of the Fupla Editor

### Features of the libraries

- ▶ Clearly set out in a tree structure, making FBox selection very easy
- ▶ Parameters are conveniently entered via adjust windows in the Fupla editor, without losing program clarity
- ▶ Obvious differentiation between data types through use of different colors



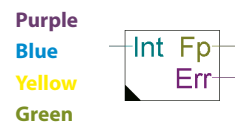

Each data type is identified by a different color. This makes programs easier to read.

- Binary data
- Integer data
- Floating-point data
- Texts (TX) and data blocks (DB)



### Clear grouping into families

All FBoxes (function boxes) are grouped into families. This provides a better overview and makes it easier to find individual FBoxes. A distinction is also made between a standard, application and user FBox:

-  **Standard:** Shows the FBox libraries of the basic application components
  -  **Application:** Shows the FBox libraries of the engineering application components
  -  **User:** Only shows the FBox libraries which the user himself has created
  -  **All:** Shows all available FBox libraries
- ★ **Favorite:** On this page the user can group together the most frequently used FBoxes (from all libraries). This means that it is no longer necessary to search for FBoxes or to switch between library tabs.

### FBoxes in the Saia PG5® Core

Standard and application FBoxes are already available to the user in the Saia PG5® Core.

The standard FBox libraries are basic families which offer normal logical and arithmetic operations as well as numerous useful system functions. The “Standard FBox libraries” diagram shows the FBox families available.

In addition to the standard FBoxes, the Saia PG5® Core contains further FBoxes. These include application FBox libraries which comprise engineering families. These are listed in the “Application FBox libraries” diagram to the right.

The search function (Filter) in the Selector enables a specific FBox to be found quickly.

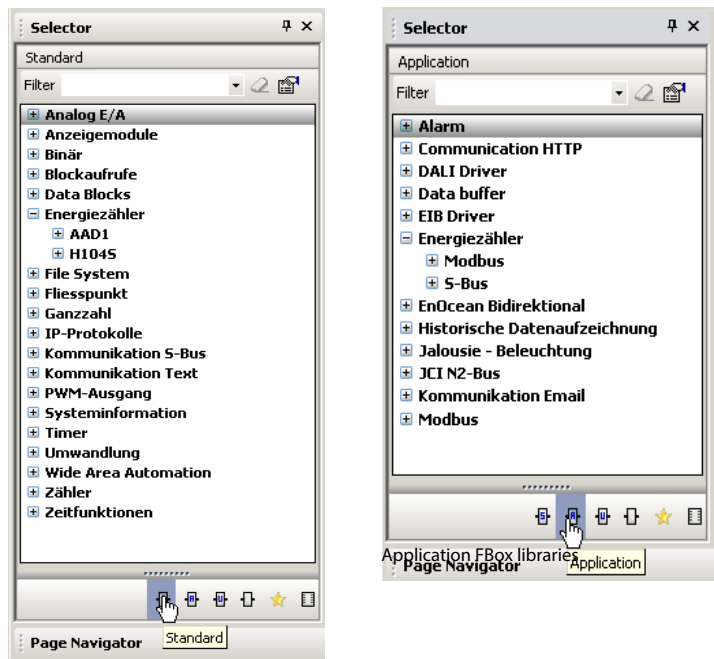

Standard FBox libraries

So that Engineering can access the correct FBoxes, their function and parameters must be known. The online user manual integrated into the PG5 Core is the ideal way to get a quick overview of the relevant FBoxes.

Clicking on the FBox makes information such as a brief description of the FBox, an explanation of inputs and outputs, information on the parameter settings and a function description of the FBox accessible to all.

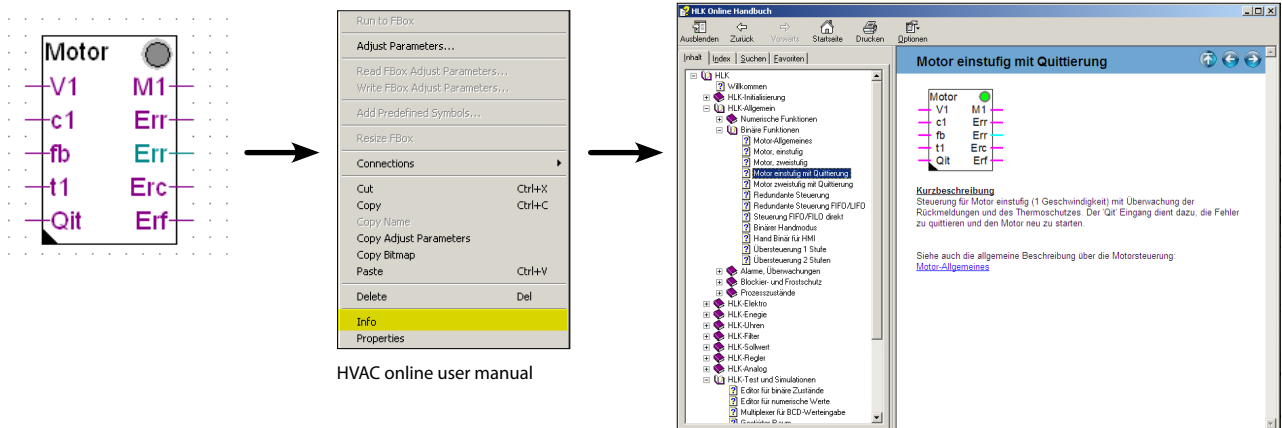

HVAC online user manual



## Selecting a FBox from the FBox Selector

The functions required to write a program can be selected in the FBox Selector and then added to the Fupla program using drag-and-drop. This makes it quick and easy to put together a program.

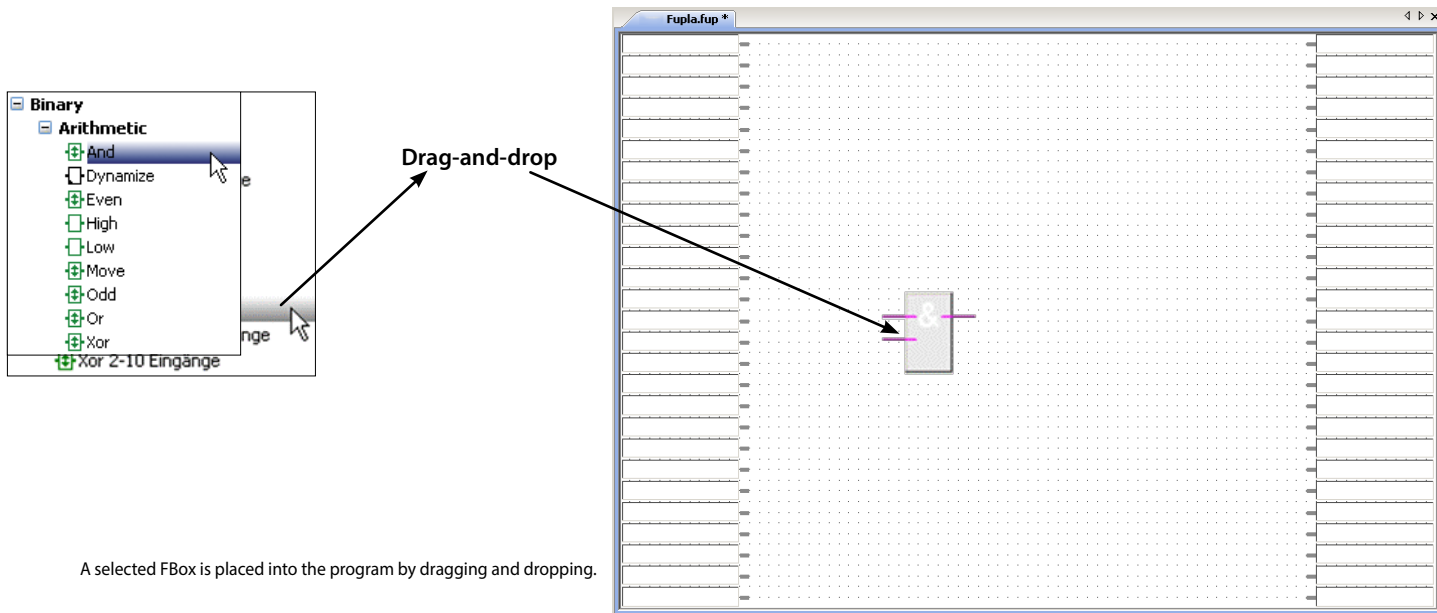

Every FBox in the FBox Selector has a symbol. The meaning of this symbol is explained below:



### FBox with adjust functions

Some FBoxes have additional "Adjust Parameters". These are shown by a black triangle in the bottom left-hand corner. Particular properties of the FBox can be configured using these parameters.

#### Offline processing of Adjust Parameters

Adjust Parameters can be processed offline via the Properties window. The values of the parameters are saved in the Fupla file. Before the PCD uses the new parameters, the program must be downloaded.

#### Online processing of Adjust Parameters

Adjust Parameters can be processed online via the "View, Adjust Window" instruction, which opens the window for online adjustment whereby both the actual and the processed values are shown. The processed values are written directly to the memory of the PCD and not updated in the Fupla output file.

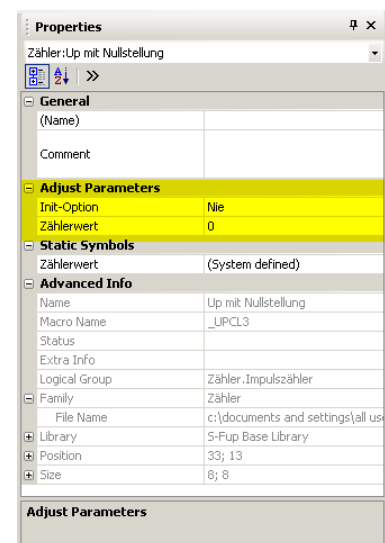

Adjust Parameters

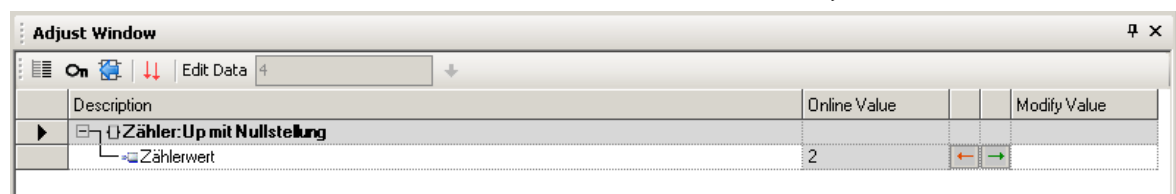

Adjust Window



### FBox with stretch function

Various FBoxes can be extended, i.e. the number of input or output connections for the FBox can be defined by moving the mouse vertically. Extendable FBoxes can be pushed back together or stretched further at any time.



### FBox without additional function

There are no additional functionalities for these FBoxes.



### Download in run mode

These FBoxes can be downloaded during run mode. The PCD does not therefore need to be set to HALT mode first.



## Web Editor – powerful software tool

The production of web-based visualization and control interfaces is an essential element of engineering effort. Appealing, functionally designed web pages are the public face of the system, supporting operational efficiency and safety. A powerful tool for generating the web pages is therefore crucial.

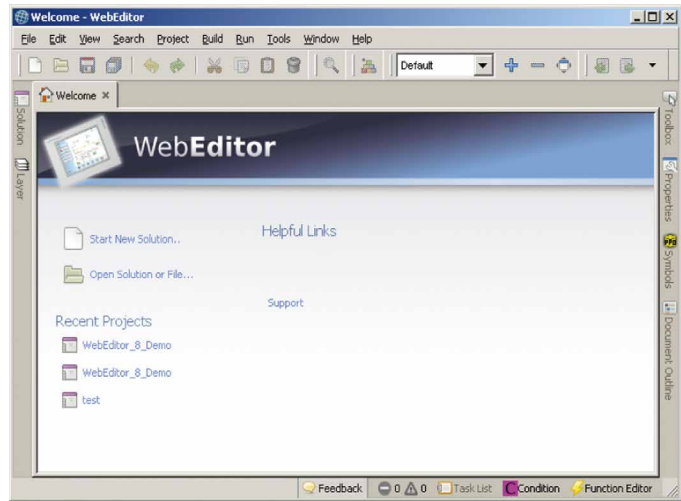

Start screen for Saia PG5® Web Editor 8

### Saia PG5® Web Editor: Simple, intuitive and efficient

Designing dynamic web pages with a normal HTML editor is laborious and requires specific know-how (in-depth HTML and Java programming knowledge). To ensure that this innovative technology does not remain the preserve of a small circle of specialists, with the Saia PG5® Web Editor, SBC provides the user with a simple-to-use software tool for generating web pages. The Web Editor is used to create Java-based web-pages simply and efficiently by placing and parameterizing objects specially tailored to the PCD web server. The use of the Editor is intuitive, and requires no HTML or Java programming knowledge. With optimum integration into the Saia PG5® Controls Suite and the associated direct access to all symbols, powerful macro management to generate your own reusable macros and many other useful functions for efficient generation of web pages, the engineering costs are significantly reduced compared to other editors.

The tool is based on the automation environment. Areas of use include system visualizations, alarming and trending functions, or just one service page. The full integration into the Saia PG5® Core, in conjunction with Saia PCD® controllers, guarantees a particularly efficient working method.

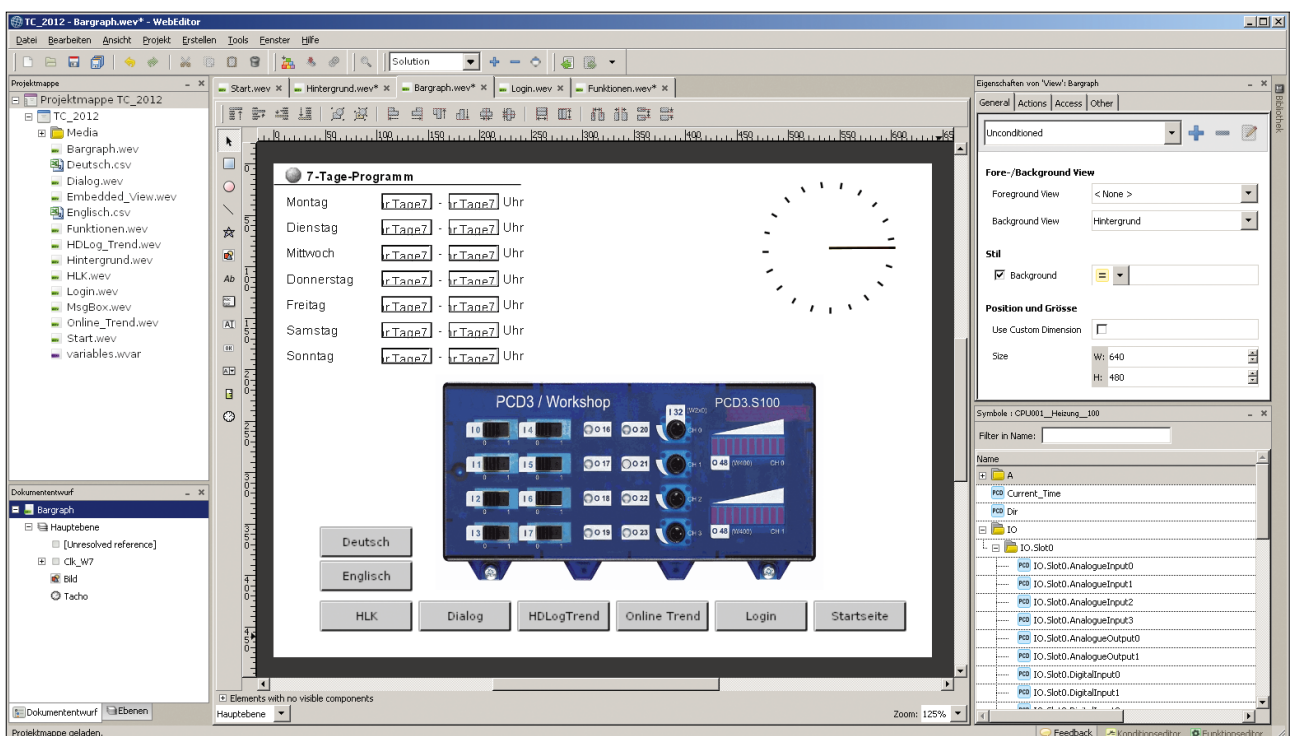

The Saia PG5® Web Editor produces appealing web visualizations without any web designer skills.

The Web Editor includes a transparent and adjustable workspace for efficient operation. The workspace essentially comprises the menu/instruction bar, the View Editor (drawing area) and windows. Thanks to docking window technology, the user can freely position and show/hide the windows as he requires.

The most important windows are explained here:

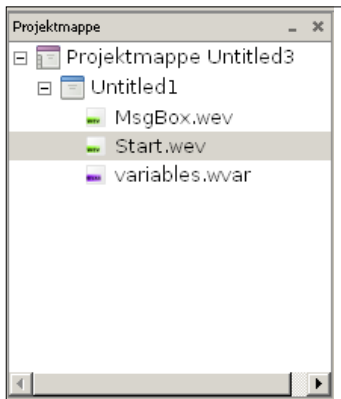

Web Editor window: Solution

The Solution shows the project and file structure. This folder can contain multiple Web Editor projects with various data types. The file types are shown clearly in an orderly tree structure.

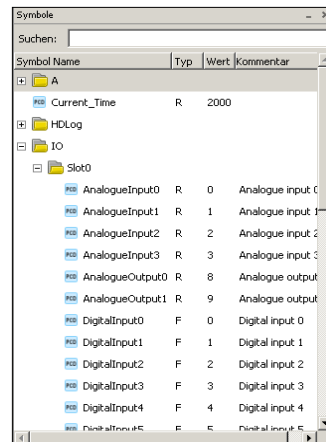

Web Editor window: Symbols

Symbols are taken over from the configured PG5 project path and updated automatically.

To find symbols quickly, the window has a search function.

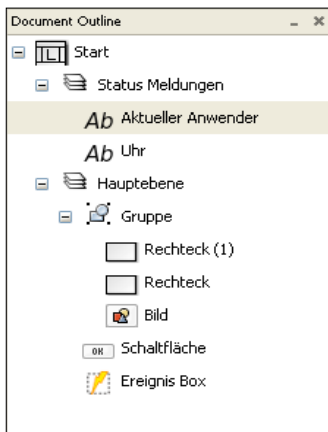

Web Editor window: Document Outline

The Document Outline window provides an overview of the structure of the current view.

With this window, an element can be selected directly, regardless of its group or level.



Web Editor window: Layers

This window provides an overview of all layers in the view currently open. Layers can be created, moved or deleted. All layers, including the background and foreground view, can be hidden for additional clarity.

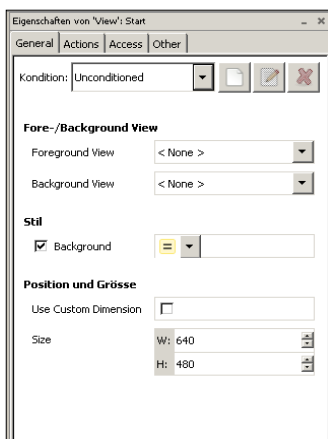

Web Editor window: Properties

In the "Properties" window, the properties and behavior of objects at runtime are quickly and easily configured with just a few clicks.

The window is subdivided into four areas:

- **General**
  - View settings (depending on conditions)
- **Actions**
  - Configuration of results (when holding down, when releasing)
  - Function key
- **Access**
  - Settings for access control
- **Other**
  - Element name and comments

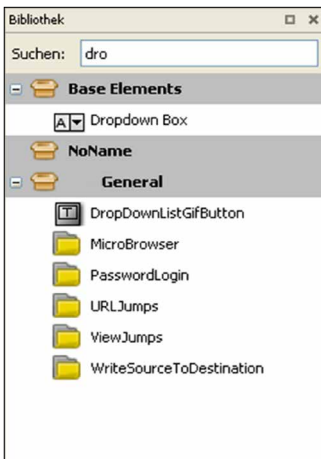

Web Editor window: Libraries

All available elements, images and templates are listed in the Library window. Like the Symbols window, a search can be conducted in the Library window. Double-clicking on an element adds it to the open view.

The library in the Web Editor includes the following library groups:

- **Base Elements**  
Templates for bar graphs, buttons, images, etc.
- **NoName**  
CheckBox Template
- **General**  
View Jumps, URL Jumps, PasswordLogin, etc.
- **Alarming**  
Objects template for alarming
- **Trending**  
Objects template for showing trends
- **Application Library**  
Template objects for HVAC and DDC Suite FBoxes
- **Icon Gallery**  
Image gallery of Controls AG

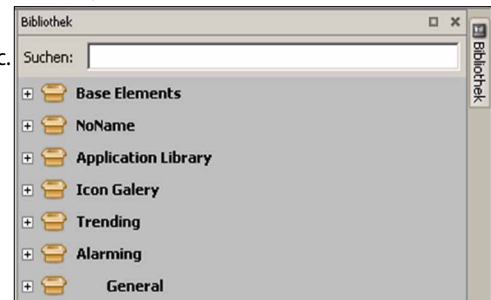

Library groups

The macros for the Trending and Alarming library groups are described below.

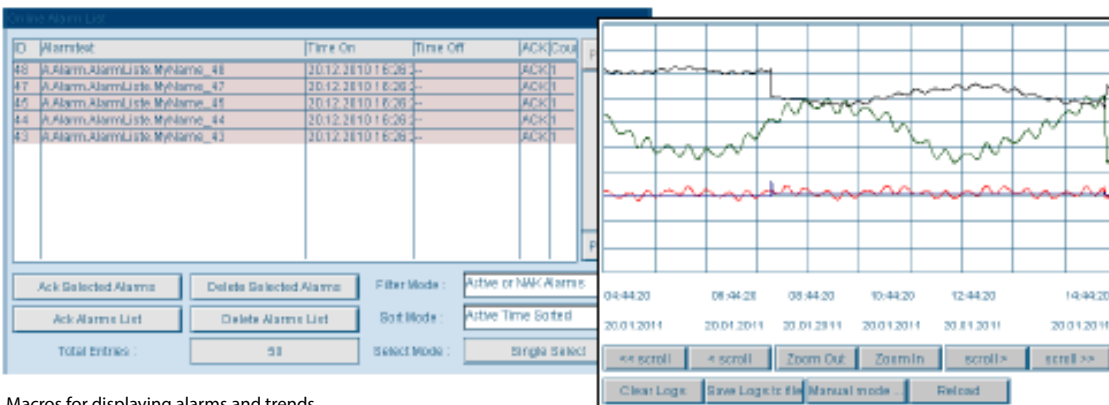

Macros for displaying alarms and trends

### Alarm macro

The system signals are monitored and alarms detected independently of the web browser in the PCD. The actual alarm function is implemented in the firmware (COSinus) of the PCD. Its activation and parameter setting take place with the Fupla FBox library. The alarms are stored in alarm lists in the non-volatile internal memory of the PCD.

### Trend macro

Historical trending is defined as the capture, display and long-term storage of time-stamped system values. Two types of trending are supported – online and offline. With online trending, the client (PC, panel) captures the data and saves it temporarily. The PLC program does not have to be modified. With offline trending, data capture and interim storage take place in the PLC system. This requires special program code (e.g. via Fupla FBoxes) to be created. The offline trend can either be saved in databases or on the PCD's file system.

### 1.1.1.3 Saia PG5® Core | Example application

With the Saia PG5® Core, all types of ICA tasks can be initiated on machines and systems. The graphical application components supplied support the use of the Saia PCD® Automation Server (web + IT) and calculation/logic functions. The basic functions of the Saia PG5® Core are shown below using a simple logic.

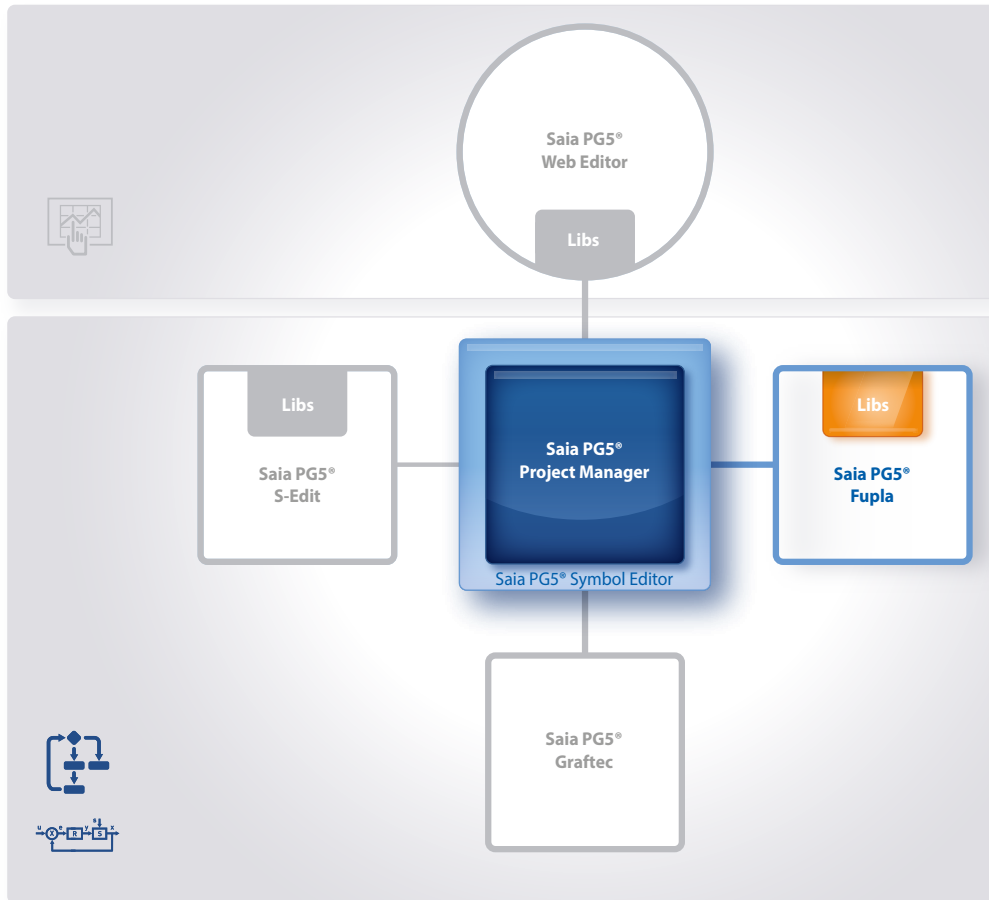

In following example application, only the Saia PG5® Core tools shown in color are used.

To start, a new project with a name and a description must be created in the Saia PG5® Project Manager. In this newly created project, one of the first steps must be to configure the communication (PC ↔ PCD).

The Online Settings must be configured in order to create a communication (PC ↔ PCD).

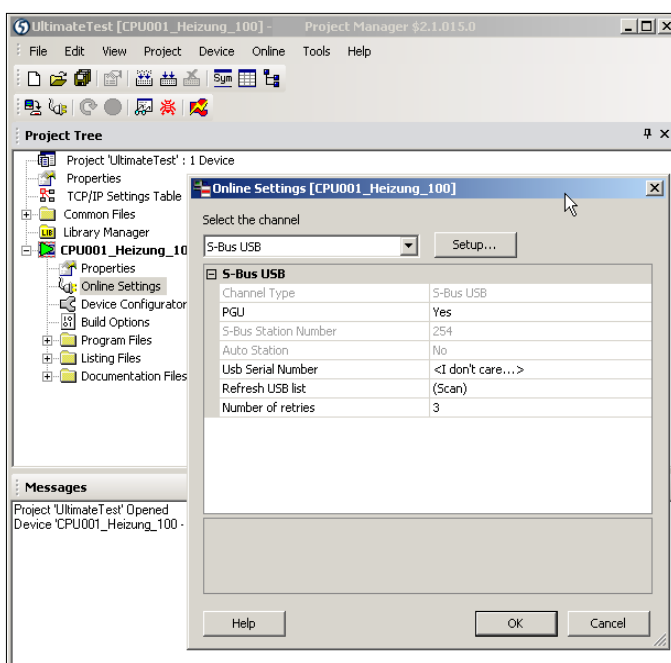

#### Online Settings

Select the channel: Select a transmission channel between the PC and the Saia PCD® controller. Here it is possible to choose between the following channels:

- PGU channel (RS-232)
- S-Bus channel (serial)
- S-Bus modem channel
- SOCKET channel (TCP / IP)
- S-Bus USB channel
- Profi-S-Bus channel

Setup: Channel configuration

Online Settings: Selection of the communication channel

The controller selection and the associated configuration are performed in the Device Configurator. The Device Configurator has multiple windows: "Device View", "Selector", "Properties" and "Media Mapping". The "Device View" window has a context menu. The menu features various options, such as Device, memory slots, Monitoring, Onboard communication, Ethernet protocols and Onboard I/O slots. The relevant components are selected in the "Device View" window and all the associated parameters displayed on the right in the "Properties" window.

Parameters which can be edited can be modified from here. If, for example, the PCD3.M5540 device was selected in the "Device View" window, the hardware settings are displayed in the "Properties" window. All modules which can be inserted into one of the slots are listed in the "Selector" window. This includes digital and analogue I/O modules, communications modules, expansion modules, etc. Modules can be taken from the "Selector" window and placed in the device slots, whereby the relevant slot is selected and then the module double-clicked in the "Selector" window. The module properties are configured via the "Properties" window.

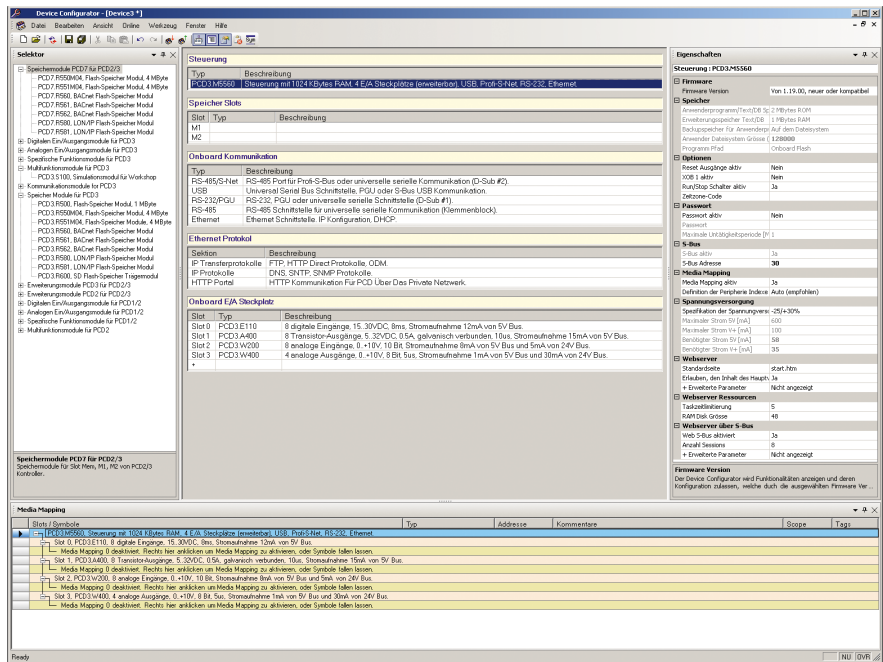

Device Configurator with the most important windows

The "Media Mapping" window shows the symbol names for all inputs and outputs. The configuration of analog signals takes place here. This window can be shown and/or hidden via the menu view → Media Mapping. After the settings have been performed, the configuration must be loaded into the controller.

After the hardware settings, a new program file can be created. Right-click on Program Files and then New in the following selection menu.

The New File dialog opens. Enter a file name. Make sure that Fupla Files (\*.fup) is selected as the File Type and close the dialog with OK.

→ Fupla file was created, now the user program can be created with FBoxes.

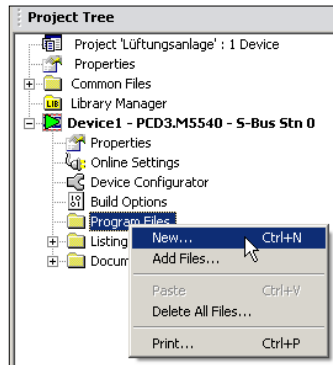

Creating a Fupla file

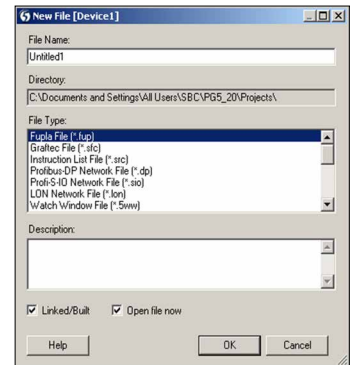

**Intuitive display as a function block diagram**

User programs can be created from various FBoxes without any extensive knowledge of programming. They can be displayed as desired in the function block diagram editor (Fupla).

In this example, the performance values of individual energy meters are continually monitored and the maximum and minimum values captured over days, weeks or even years. The voltage and power is compared with variable limit values. If exceeded, a relay output is activated which can be used, e.g., to control a signal lamp or to introduce a peak load cut-out. In addition, an e-mail can be sent to notify a specialist.

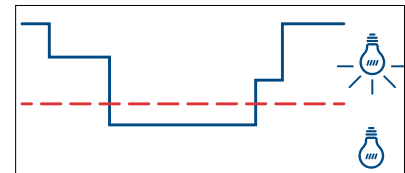

Monitoring performance values

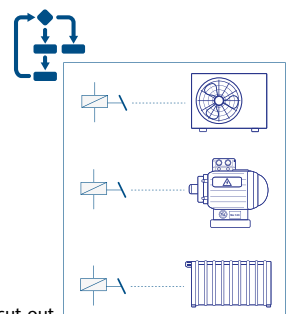

Load cut-out

An extract from the load cut-out is explained and presented below. Only the most important FBoxes are dealt with here.

It should be made clear that a simple logic can be implemented with the FBoxes already in the Saia PG5® Core.

### S-Bus energy meters

This FBox is used to read the energy meter using the S-Bus interface.

The energy meter supplies the current power consumption values of the consumers connected. For the example above, the power and voltage are used.

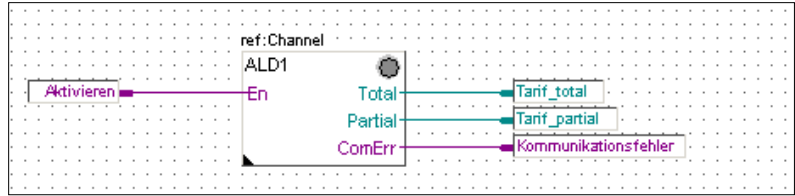

FBox – Energy Meter S-Bus

In the Symbol Editor it can be seen which tabs and flags can be used.

Symbol Name	Type	Address/Value	Comment	Actual Value	Tag	Scope
ALD1_0	GROUP					
→ Status	R		(3) Status/Fehlermeldung(en) des Energiezählers	2007		Public
→ Partial	R		(2) Zähler Partial	2001		Public
→ Total	R		(2) Zähler Total	2008		Public
→ PartClear	F		(2) Zähler Partial zurücksetzen	2004		Public
→ Ph_U	R		(2) Phase Spannung	2006		Public
→ Ph_I	R		(2) Phase Strom	2003		Public
→ Ph_P	R		(2) Phase Leistung	2004		Public
→ Ph_Q	R		(2) Phase Blindleistung	2005		Public
→ Ph_Sco	R		(2) Phase Cosinus phi	2002		Public

Symbol Editor

### Arithmetic FBoxes – Comparison

Is greater or equal to: Binary output is set if the top input is greater than or the same as the bottom input. Otherwise the binary output is not activated. Signal if limit value is exceeded

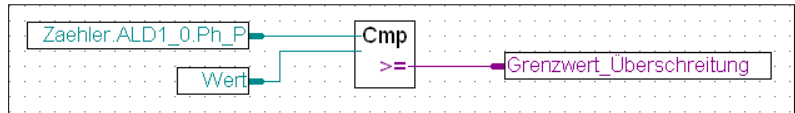

FBox – Integer Comparison

### Data capture

The HDLog FBox records up to 10 values for a historical data evaluation. The values are first saved in a buffer (RAM DB) and written to a CSV file depending on the parameterization. The resulting files can therefore, for example, be forwarded via an e-mail (see below, FBox family communication e-mail), read via FTP access or read and displayed via a web application.

In our example application, the energy data evaluation is performed with this FBox.

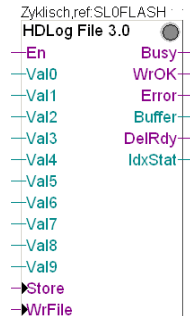

HDLog FBox

### E-mail

The e-mail function and integral SMTP (Simple Mail Transfer Protocol) client enable PCD controllers to send process and system information to an e-mail server via the Ethernet interface. Alarm, service and status messages – or any process information required – can therefore be sent by e-mail to a management center and/or to service personnel. The data saved previously is sent as an attachment. Convenient Fupla FBoxes are provided in order to use the e-mail functions.

Thus in our example, a limit value being exceeded can be reported directly to the responsible member of staff.

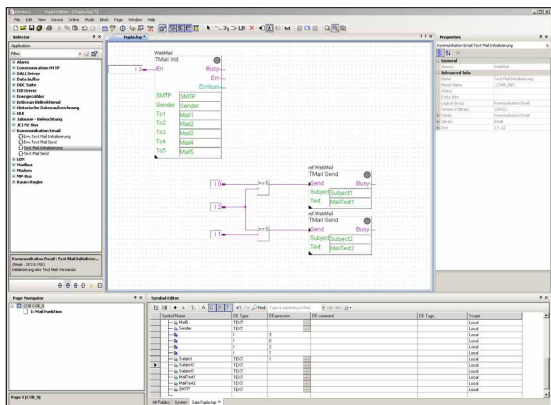

Sending e-mails with the PCD

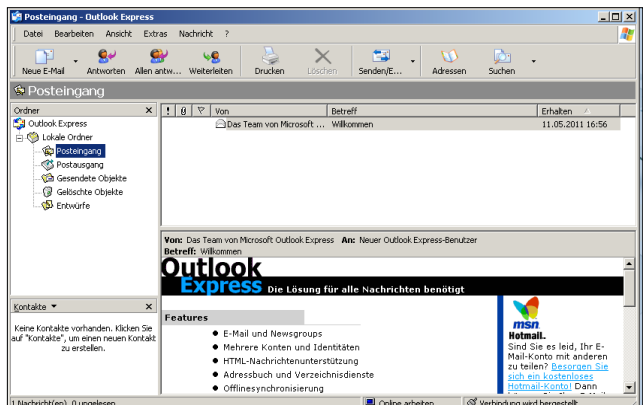

The FBoxes named above must now be positioned in the Fupla program, described and linked with each other.

→ We therefore have a finished Fupla program.





Rebuild All Files

### Generating a program (Build)

So that the finished edited program can be read and run by the PCD, it must be generated in the Project Manager via Menu → Device → Rebuild All Files or using the Rebuild All Files button in the Fupla Editor or in the Project Manager.

The results of the various program preparation steps (Compiler, Assembler, Linker) are shown in the Messages window.

If the program has been edited correctly, the build function is completed with the message: Build successful. Total errors 0 Total warnings 0

Any errors which have occurred are shown as error messages. By double-clicking on the error message, the error concerned can easily be localized in the user program.



Download Program

### Transferring the program to the PCD (Download)

The user program is now ready and just needs to be transferred from the PC to the Saia PCD®. This is done using the Download Program button or the Online "Download Program" menu command in the Project Manager.

Should any communications problems arise, the configuration settings (Online Settings) and the PC ↔ PCD connection with the USB cable must be checked.

As soon as a system function is implemented with FBoxes and has been downloaded to the controller, the current project values can be displayed using "Go online/offline".

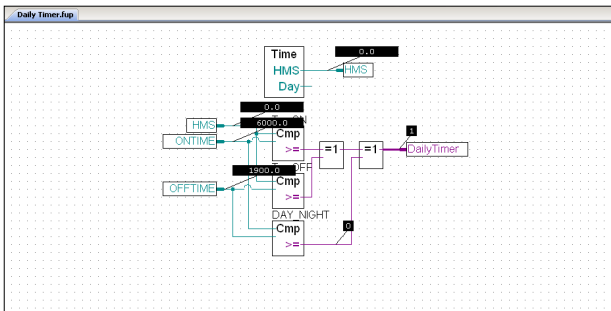

Fupla program – "Go online"

"Go online" causes the current project values to be displayed.

If "Go online" is activated, all binary connections show the current status by means of the line thickness:

Thin "purple" line: Status = 0

Thick "purple" line: Status = 1

By clicking on the line the current value can also be displayed. This also applies to analog values.

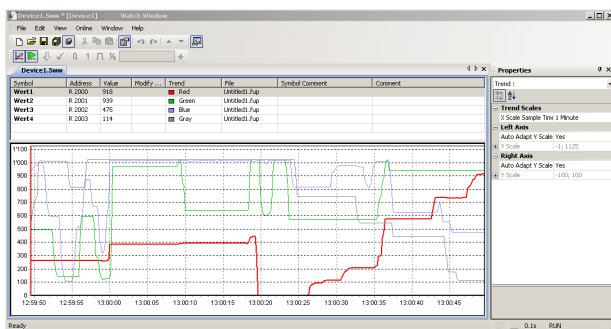

Watch Window

Via the Watch window, it is possible to show selected online data such as the status of inputs/outputs or the content of variables of various Fupla pages over a specific time. Data can be displayed and changed here.

Data can be entered manually or imported using copy/paste and drag-and-drop. A successful build of the PG5 program automatically updates the symbols with their new address. This also works with the Watch Window open.

## 1.1.2 Saia PG5® HVAC modules and use

### 1.1.2.1 HVAC modules

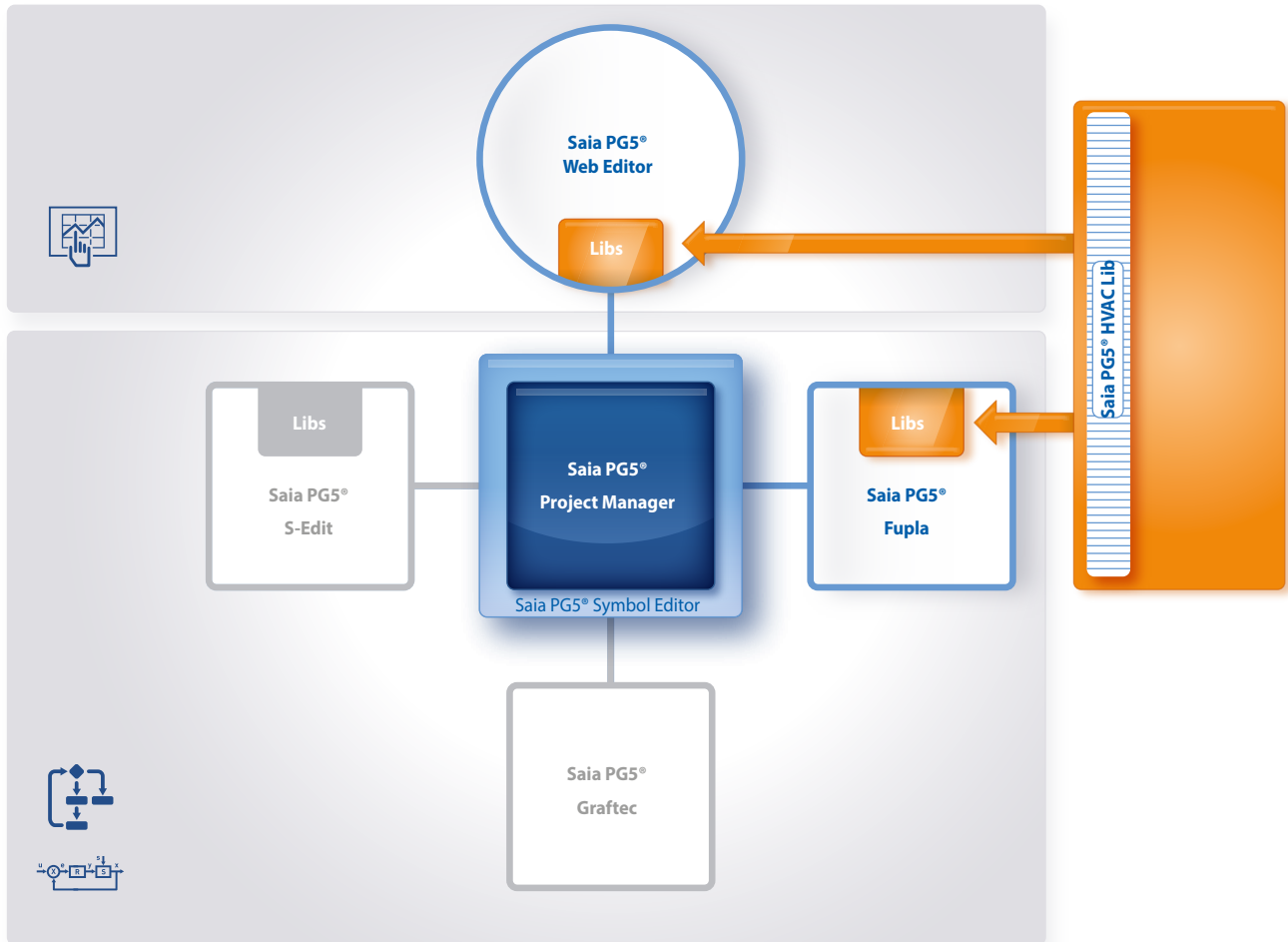

Saia PG5® Core + HVAC library. The visualization is created using the Web Editor.

With the FBoxes included in the Saia PG5® Core package, the majority of the program functions can already be implemented. In addition, other libraries for special areas of use are available. The HVAC library, for example, has an efficient collection of complex control modules (FBoxes) for the heating, ventilation and air conditioning systems area. These functions simplify the engineering of the technical systems of buildings.

#### The HVAC library contains the following FBox groups

- **Analogue:** Function blocks for individual scaling of each individual analog input or output
- **Clocks:** Daily program, weekly program, annual program, clock with multiple switching periods in one FBox, national holidays, monthly switch-offs or switching periods one after the other on the same day, as well as FBoxes for reading and writing clock data
- **Controllers:** Two-point controller, three-point controller, boiler loading, P, PZ, PI, PID, P-PI, P-PID controllers, incoming air mixers, controller sequences, mixer sequences
- **Electric:** FBoxes for lighting control, window blind control and step switches
- **Energy:** Energy meters, pulse counters, monthly statement, enthalpy, switching heating on/off, load cut-out
- **Filters:** Filter, limitation, ramp limitation, average of measurement values, dead zone, dead range with delay, zero zone, hysteresis
- **General:** FBoxes for numeric functions, binary functions, alarms, monitoring, motor, blocking and frost protection, process states, switches and the conversion of data types
- **Init:** Initialization of the subfunctions for the HVAC library
- **Set-Points:** Heat curve, heating demand, setpoint device, setpoint ramp, setpoint adjustment
- **Test:** Simulation of values and states

HLK	
+	Allgemein
+	Analog
+	Elektro
+	Energie
+	Filter
+	Init
+	Regler
+	Sollwert
+	Test
+	Uhren

### 1.1.2.2 Example application of the HVAC library

The HVAC FBox library is used in order to implement an HVAC system in the following example. The following system should be controlled and regulated by a PCD. The implementation of the Fupla program is shown clearly on the next few pages in step-by-step instructions.

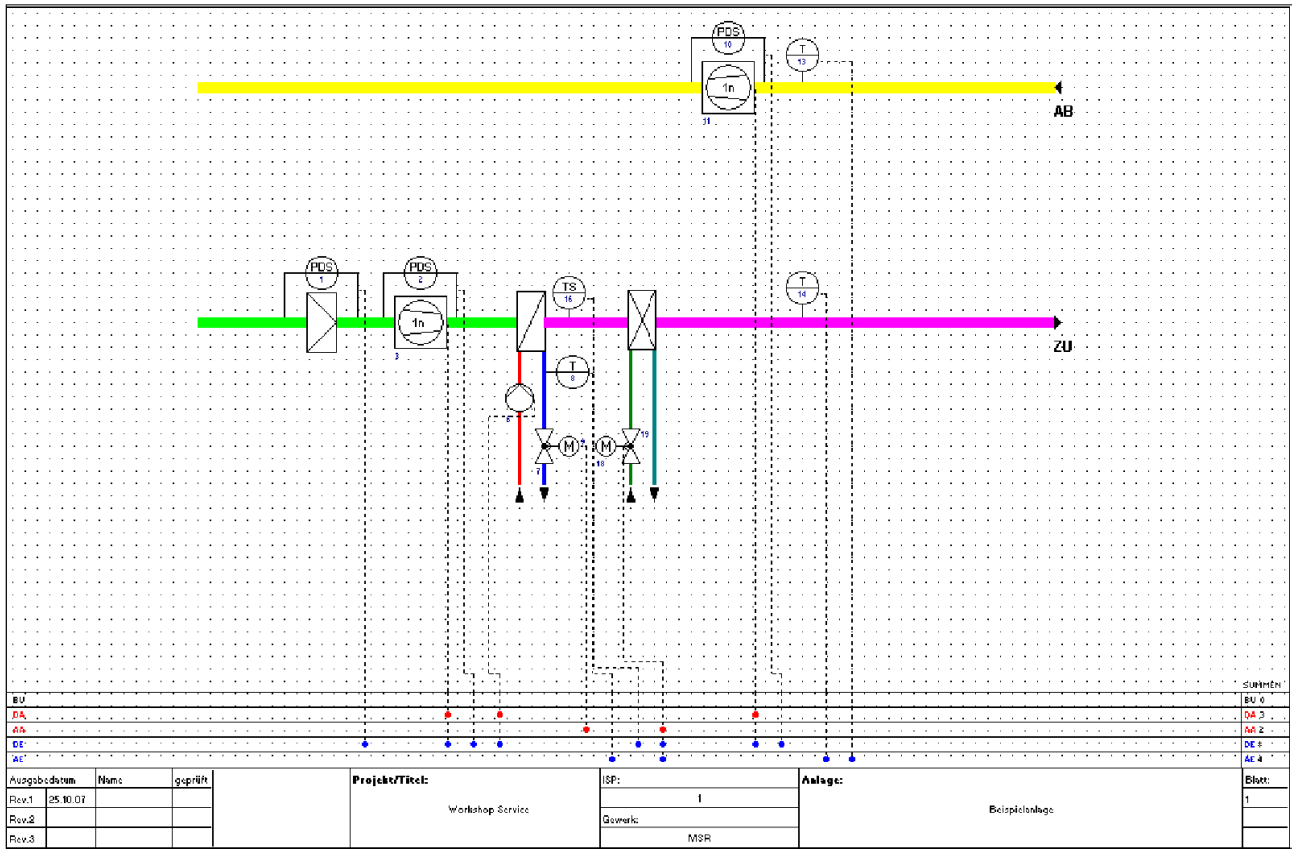

Example application of the HVAC modules – HVAC system

To start, a new project must be created in the Saia PG<sup>®</sup>5 Project Manager. No adjustment is made on the Device Configurator in this example. This example is merely intended to show the use and application of HVAC FBoxes.

An appropriate name and a description is assigned to the project.

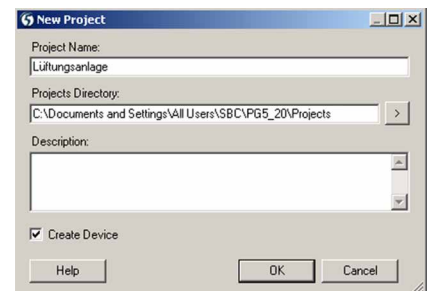

Entering a project name

After creating the project, a new program file must be created.

To do this, right-click on Program Files and then New in the following selection menu.

The New File dialog opens. Enter Ventilation as the file name, for example. Make sure that Fupla Files (\*.fup) is selected as the File Type and close the dialog with OK.

Now open the Fupla program by double-clicking on the file created.

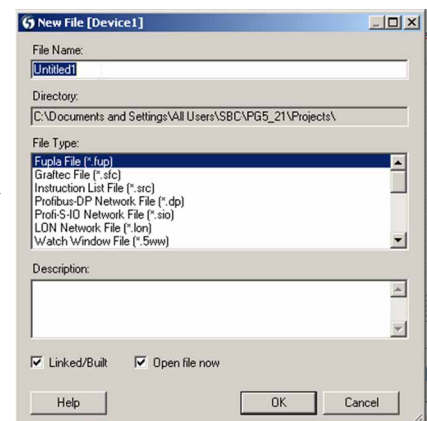
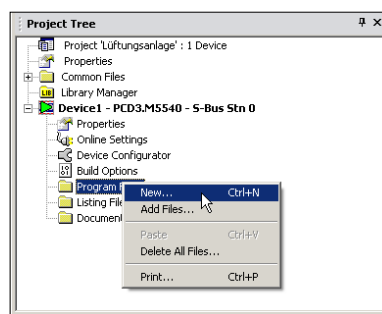

Creating a Fupla file and assigning a name

The project requires 2 COBs with a total of 9 Fupla pages.

Right-clicking on the COB opens the Properties window opposite. Here there are instructions with which new pages are created ("Insert Page") or a name assigned ("Properties").

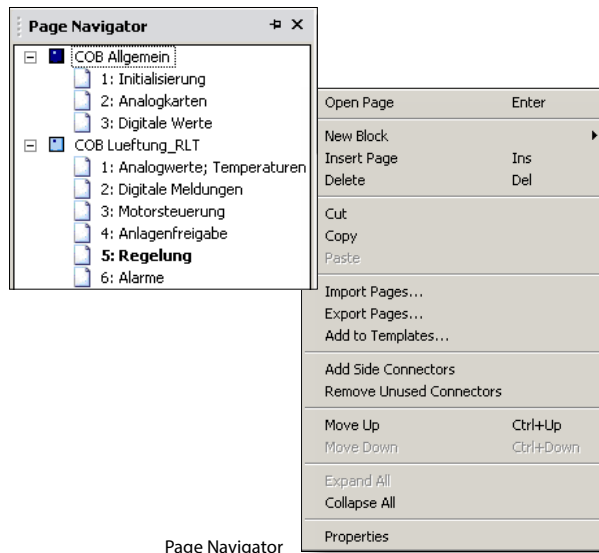

Page Navigator

### Initialization

If the user wishes to use FBoxes from the HVAC library, he must place an HVAC initialization FBox at the start of the Fupla file.

Various common properties of the HVAC FBoxes, such as the behavior of the FBox after loading or the start-up behavior when switching on the PCD, are set with this initialization FBox.

Initializing FBoxes

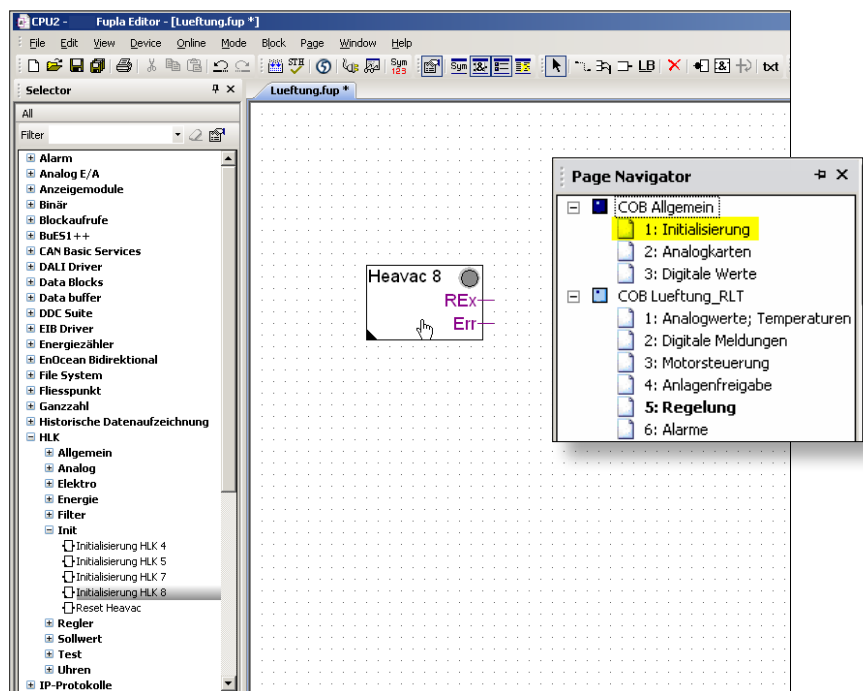

### Capturing analog values

The temperature values for outside, supply and exhaust air and the return flow are to be captured. To do this, the Conversion FBox from the HVAC General FBox family is placed on the page four times, then the Filter T1 FBox from the HVAC Filters FBox family placed next to each one.

The FBoxes and Connector must be connected.

Assign the FBoxes a name. (Right click on FBox – Properties → Name).

Create symbols in the Symbol Editor and move them to Connector using drag-and-drop.

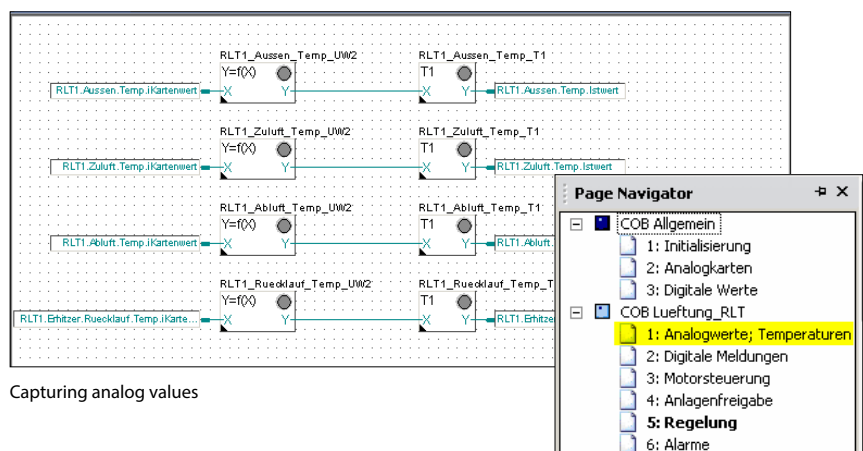

Capturing analog values

	Aussen	GROUP			
	Temp	GROUP			
	ikartenwert	R		Wert aus der Analogeingangskarte	Public
	Istwert	R		Physikalischer Wert	Public

Symbol Editor

### Capturing reports

The seven reports for filter, frost protection and motors are to be captured.

Place the Digital Reference FBox from the HVAC Test FBox family (Application tab) on the page as shown, then the Xor FBox from the Binary Arithmetic FBox family (Standard tab) and move them to two inputs.

Add symbols from Symbol Editor as before.

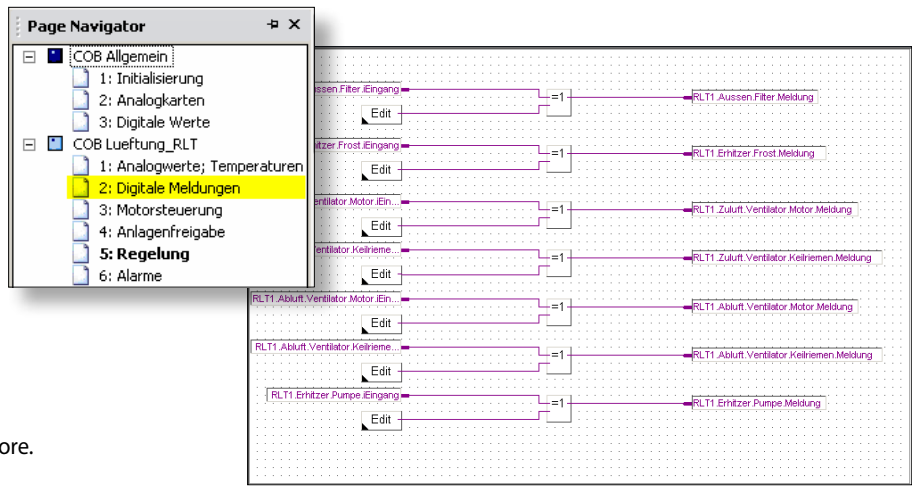

Digital messages

### Motor controllers

Place the Motor 1 speed+Ack FBox from the HVAC General FBox family (Application tab) on the page three times as shown.

Place the inputs/outputs on the FBox using the button from the Connector menu as shown.

Display the Symbol Editor using F5.

Create a new sub-group. We can now create symbols in the sub-group. Then move the symbols just created to Connector on the Fupla page via drag-and-drop.

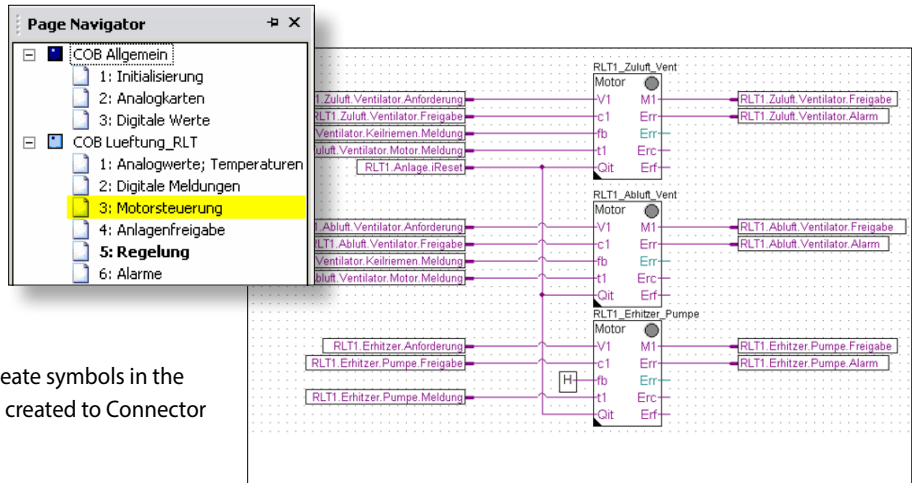

Motor controller

### System release

The system should be connected via a clock and the pump via the external temperature.

Place the Clock 7 days FBox from the HVAC Clocks FBox family (Application tab) and the Override 1 Stage FBox from the HVAC General FBox family on the page four times as shown. Place the Anti-blocking pump FBox from the HVAC General FBox family and the Controller 2 points and sequence 2 points FBoxes from the HVAC Controllers FBox family as shown on the page.

Place the Or FBox and the And FBox from the Binary Arithmetic FBox family on the page as shown. Set the Connector as shown opposite on the page and connect the elements.

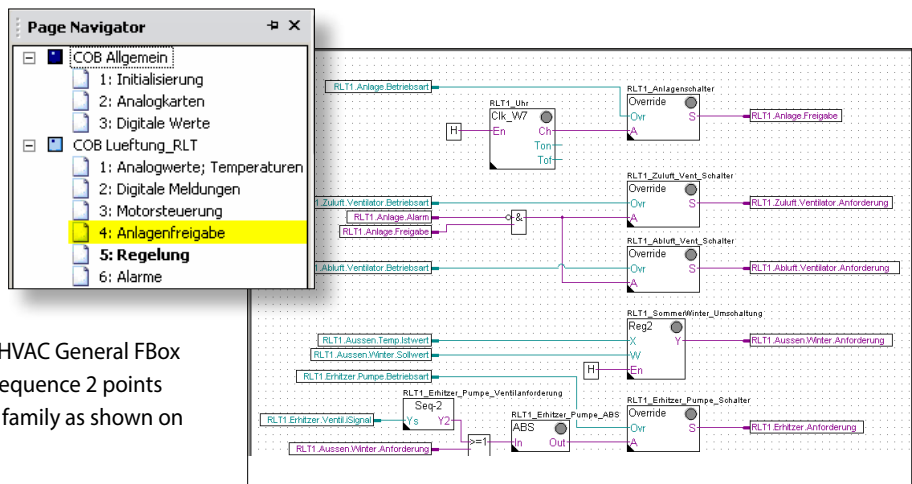

System release

### Control

The system should receive a supply/exhaust air temperature cascade as a control.

Place the W/Ambient temperature FBox from the HVAC Set-Points FBox family and the Controller PI and Sequence Master HC FBox from the HVAC Controllers FBox family on the page as shown. Place the Maximum FBox from the Integer Arithmetics FBox family on the page as shown. Connect the elements. Now a few basic settings still need to be made in the FBoxes. The Properties window opens by clicking on the FBox. All values are experience values which can be used to control temperature as a basis for adjustment. Obviously these values must be adjusted according to the control behavior during operation.

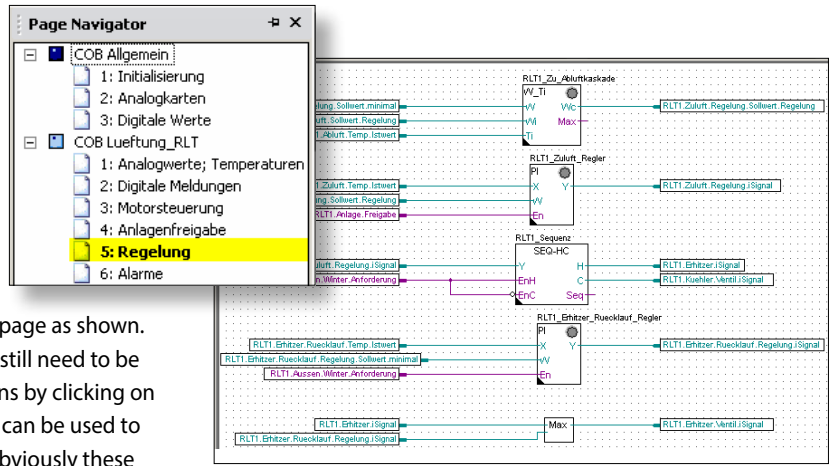

Control

### Alarm processing

We still need to process messages as alarms. Place the Alarm inhibit 1–10 FBox from the HVAC General FBox family with two inputs and the Alarm FBox on the page as shown. Then position the Or FBox from the Binary Arithmetic FBox family with four inputs, set the Connector and connect all the elements as shown. The FBox with the name VS\_01\_alarm saves the alarm until it is acknowledged. Since the motor alarms are already saved in the Motor FBox, this can be connected via the Or FBox to the VS\_01\_alarm\_ssm FBox. This FBox is designed to provide a visual and audible alarm notification. The s1 output is reset once acknowledged and the s2 output switches from flashing to being permanently on. Only once the alarm is cleared does s2 also go out.

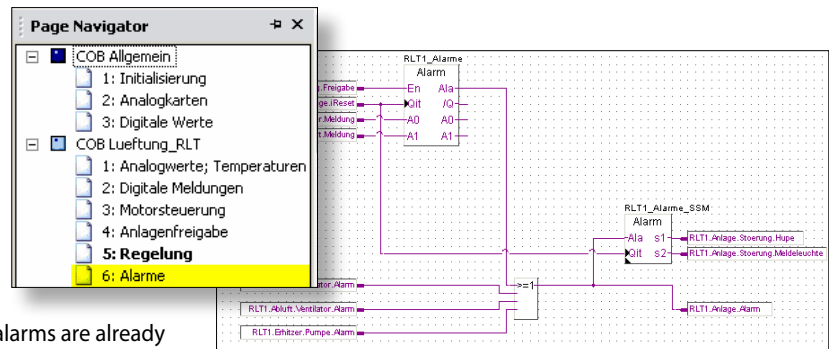

Alarms

### Physical inputs and outputs for the test

Position the PCD2.W4 FBox from the HVAC Analog family and move this to two inputs. Position the PCD2.W2 FBox and move this to four outputs. Connect all FBox inputs and outputs with connectours. Enter O 112 in the PCD2.W4 FBox. There must be a space behind O so that the exact output can be identified. The same applies to I,F,R, etc. Enter I 96 in the PCD2.W2 FBox. Move the associated symbols via drag-and-drop from the Symbol Editor to the Connector to the FBoxes.

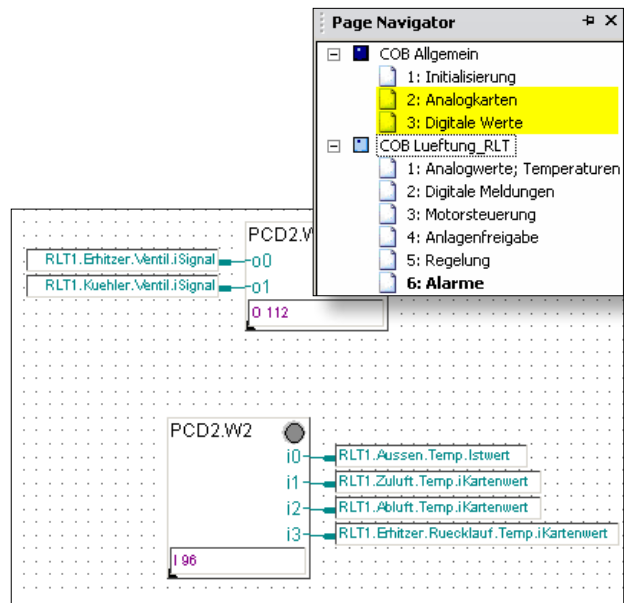

Analog board

Position the Override digital FBox from the HVAC General FBox family on the page as shown. Set the connectors and connect all elements as shown. In the Symbol Editor, add the symbol name IO and 0 as the address.

Return to the symbol name and enter ..7 next to the address IO and click Enter. The Symbol Editor automatically creates the symbols I1 to I7 with the relevant address for you. Repeat this for the digital outputs O16...23 with address 112 to 119. Now move the symbols just created to Connector on the Fupla page via drag-and-drop.

The symbols are now linked to the inputs and outputs and can be tested.

The Fupla program shown is a summary of a possible exercise from the basic course on building automation workshop.

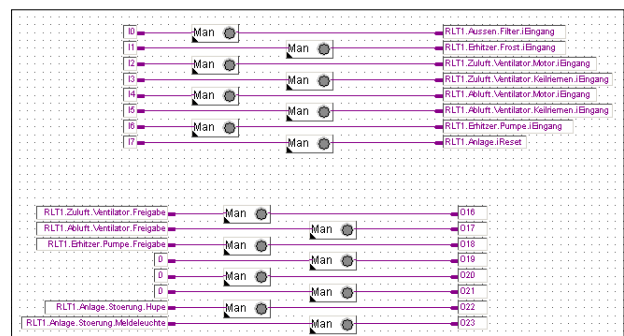

Digital values



### 1.1.3 Increasing engineering efficiency through installation templates

#### 1.1.3.1 DDC Suite

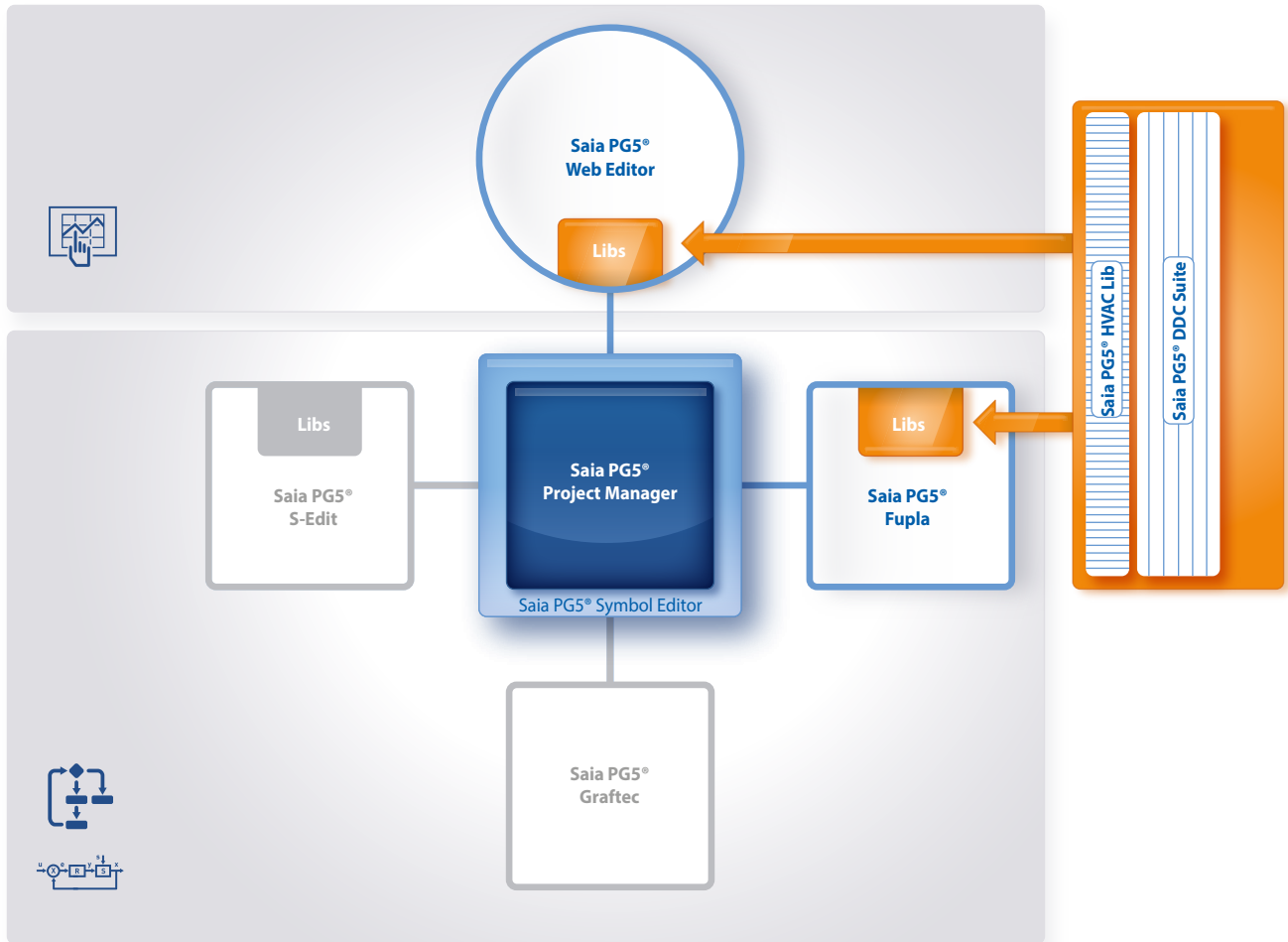

Saia PG5® Core + DDC Suite library

Using the Saia PG5® DDC Suite library and templates makes the creation of HVAC applications even simpler. Complex program structures and application elements such as complete pump controllers, incl. hour meters or entire control tasks for ventilation systems are grouped together as templates in individual function boxes and optimally add to the current HVAC library. This means that projects can be implemented efficiently.

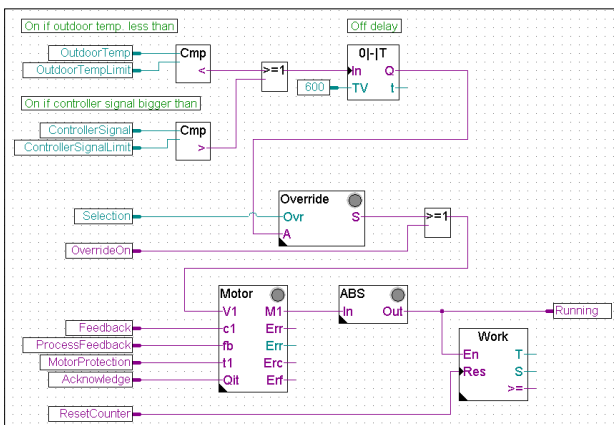

Complete pump control with HVAC library

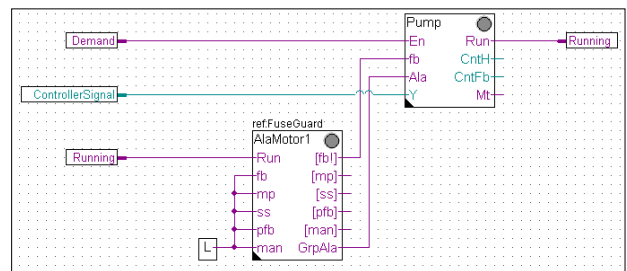

Complete pump control with DDC Suite library

We can already see a number of benefits when comparing the two Fupla pages (HVAC and DDC Suite).

- It is easier to read and understand the Fupla program – fewer FBoxes and links on one page.
- Arranged clearly and transparently – easier to handle, e.g. for new colleagues in the developer or service team
- Easy to maintain

The following FBox families are available to the DDC Suite library user:

- **DDC Alarming:** Fault modules for motors, fire protection and various components
- **DDC Analogue values:** FBoxes for capturing measurement values
- **DDC Controller:** Control modules for components such as cooler, heat recovery system and heater
- **DDC Controls:** Triggering of motors, pumps, flaps and drives
- **DDC General:** General FBoxes such as manual information, media access
- **DDC Initialisation:** Modules which must be inserted once into a Fupla and which provide basic functions.
- **DDC Set-Points:** Conversions, setpoints
- **DDC Systems and Clocks:** Clocks, systems and aggregate switches

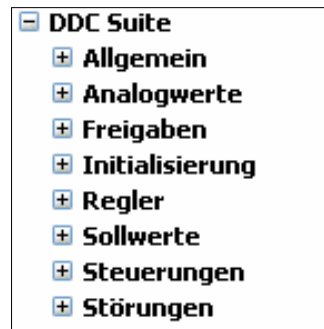

DDC Suite library

This FBox library with highly integrated FBoxes uses individual data points and creates groups and symbols automatically.

The unique features of the DDC Suite are divided into 5 points:

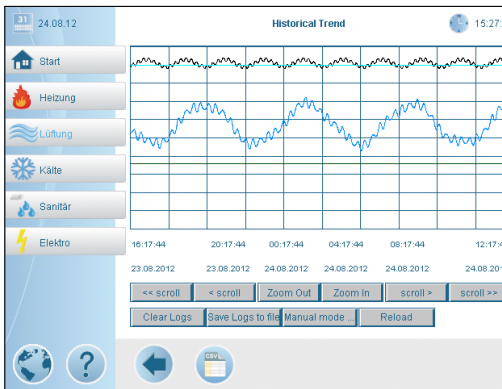

Trending

### 1. Integrated trending (offline history)

If, in addition to the actual control and regulation of a system, data is also to be recorded, this is easily done using the Saia PG5® DDC Suite.

By defining the memory size in the object parameter window, the data capture for trending can be initiated. When the automation system is running, the data is now continually saved in the Saia PCD® and is available for evaluation.

In addition, a document (.txt) containing all parameterized historical data is saved in the Saia PG5® Project Manager. A list of the trend settings can be seen in this file. There is one entry for each trend with all the details.

Properties	
DDC Analogwerte: Messwert 2.0	
General	
(Name)	
Reference	FuseGuard
Comment	
Adjust Parameters	
Systemfunktionen	
PCD Offline Trending (KB)	1
PCD Alarmverwaltung (In)	16
BACnet	Nein
Messwert	
Kartentyp	1:1
Korrektur	0.0
Filterung	
Glättung Abtastung Sek.	1.0
Glättungsfaktor	10
Umrechnung	
Physikal. Wert min.	0.0
Physikal. Wert max.	100.0
Eingang min	0
Eingang max	4095
Meldungsunterdrückung	bei bel. Spg.
Grenzwerte	
Grenzwert überschreiten	100.0
Grenzwert unterschreiter	0.0
Static Symbols	
Advanced Info	
Object parameter window (Name)	

ID	Alarmtext	Time On	Time Off	ACK	Counter
1	Error Battery	01.01.1990 00:27:12	01.01.1990 00:31:15	ACK	2
2	Error M1 Flash	--	--	--	0
3	Error SL0 Flash	--	--	--	0
4	Error RS485	--	--	--	0
5	Error RS485	--	--	--	0
6	A.Alarm_ThisAlarmList.M--	--	--	--	0
7	A.Alarm_ThisAlarmList.M--	--	--	--	0
8	A.Alarm_ThisAlarmList.M--	--	--	--	0
9	A.Alarm_ThisAlarmList.M--	--	--	--	0
10	A.Alarm_ThisAlarmList.M--	--	--	--	0
11	A.Alarm_ThisAlarmList.M--	--	--	--	0

Filter Mode:

Sort Mode:

Total Entries: 
 Select Mode:

Alarming

## 2. Integrated alarming

The principle of the trend function also applies to alarm functions. By defining the alarm number in the object parameter window, the alarms are listed in a CSV file with numbers and text.

With Version 2.5 of the DDC Suite, the system identification key can be created completely freely directly from Fupla. The aim is to create the system identification key for the S-Web alarm texts and BACnet® completely freely according to the specifications from the Fupla program. The system identification key can have up to 12 levels. The general section (levels 1-10) is specified conveniently from a central FBox.

This FBox can be positioned multiple times. Within the FBox it can be selected what the key is to be used for. Thus, for example, various system identification keys can be created for S-Web alarming, the BACnet® Object Names and the BACnet® Description. If on certain Fupla pages, for example for various systems, other levels are used, a further FBox is simply placed on the page. These FBoxes can also be used as often as desired and the changes to the system identification key are valid for the next FBox of this type. Thus a different name key can be used for each system.

Name	Value/Unit
Presence Value	%CafeAbkult Ventilator Steuerung Ausgang
Description	Cafe_Abkult_Motor / Cafe_Abkult Ventilator Steuerung Ausgang
Device Type	--
Reliability	no fault detected
Out Of Service	FALSE
Priority	normal
Inactive Text	Off
Active Text	On
Minimum Off Time	0
Minimum On Time	0
Priority Array 01	%A.BACnet.Cafe_Abkult_Motor.Prio(BValue);%A.BACnet.C...
Priority Array 02	--
Priority Array 03	--
Priority Array 04	--
Priority Array 05	--
Priority Array 06	--
Priority Array 07	--
Priority Array 08	%A.BACnet.Cafe_Abkult_Motor.Prio(BValue);%A.BACnet.C...
Priority Array 09	--
Priority Array 10	--
Priority Array 11	--
Priority Array 12	--
Priority Array 13	--
Priority Array 14	--
Priority Array 15	--
Priority Array 16	%CafeAbkult Ventilator Steuerung Ansteuerung;%A.BACne...
Relinquish Default	inactive

BACnet configurator

## 3. Automatic generation of the BACnet® configuration

For BACnet® projects, the BACnet® object list is created automatically, which saves a great deal of error-prone manual work. The automatic generation of the BACnet® objects is the main reason why so many customers use the DDC Suite. In building automation, it is normal for all systems to map relevant hardware and software data points to BACnet® objects. This may mean that multiple data points are used in a BACnet® object. Thus, for example, a binary output could receive exactly the same return message and be monitored via intrinsic alarming. The control templates for the DDC Suite already contain all BACnet® definitions which can be activated by clicking, thus BACnet® originates at the click of a button.

**Reservierter Speicher** 3 KB

Aufgezeichneter Wert Messwert

Trendstempeltyp Istwert

**Alarmverwaltung**

Die ermittelten Alarmdatenpunkte können in einer internen Alarmliste aufgezeichnet werden. Die Anzahl und die definierten Alarmnummern sind nachstehend aufgelistet.

Alarmbezeichnung	Nummer
Oberer Grenzwert überschritten	1
Unterer Grenzwert unterschritten	2

**BACnet Objekte**

Teile der Datenpunkte können für BACnet bereitgestellt werden. Höherwertige Optionen beinhalten auch die niederenwertigen.

Parameter	Wert
Parametrierte Option	1

Opt.	Datenpunkt	Objektinfo
1	Messwert	AI / Alarm

**Binärvorgabe HZG01\_Heizperiode\_Scheduler**

Vorgabe eines Wertes mit 2 Zuständen.

Parameter	Wert
Voreinstellung (0=Aus, 1=Ein) ????	1

HTML document

## 4. Automatic documentation

The engineering documentation can be created quickly at the click of a button. The documentation on all DDC Suite FBoxes is created as an HTML file. This file contains a general description with all parameters and settings. The documentation can be saved in the PCD and, for example, be used for viewing via the web. It is, however, also possible to post-edit the documentation using a text processing tool and to add images from the SCADA/web application.

## 5. Templates for Fupla, Web Editor and Visi.Plus

The Saia PG5<sup>®</sup> DDC Suite largely comprises a highly integrated FBox library which is supplemented by a growing number of ready-made, tested and ready-to-use Fupla pages which fully map the typical parts of the system in terms of function. The Saia PG5<sup>®</sup> DDC Suite also provides the operating and visualization function for each FBox. Operation and visualization using the web browser or Visi.Plus is already integrated and ready for use.

### ► Fupla templates

In order to reduce the system programming time, entire applications (heating circuit, water heating, ventilation systems, etc.), including the calendar and control tasks, are fully integrated for free selection. Some suggestions for control settings and for system control can thus be freely added, changed or integrated.

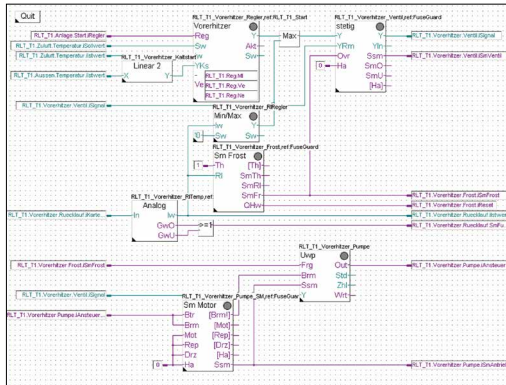

Template: Ventilation system

### ► Web Editor templates

The DDC Suite is also accompanied by template objects for S-Web applications. Graphical objects and control objects are available for each FBox. There are also S-Web system templates for predefined systems.

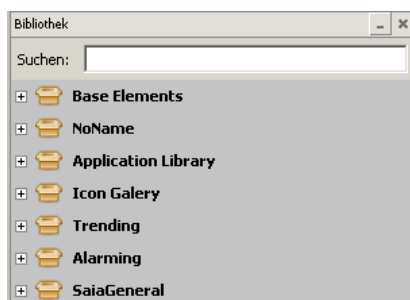

All official macros can be found in the "Library" Web Editor window.

### ► Visi.Plus templates

When importing data from Fupla to Visi.Plus, FBoxes are identified and then handled by the Visi.Plus database as FBoxes. Not only are the data points imported, but the alarms and historical trends are automatically created upon import. In addition, the Visi.Plus user is provided with the same template objects as in Web Editor.

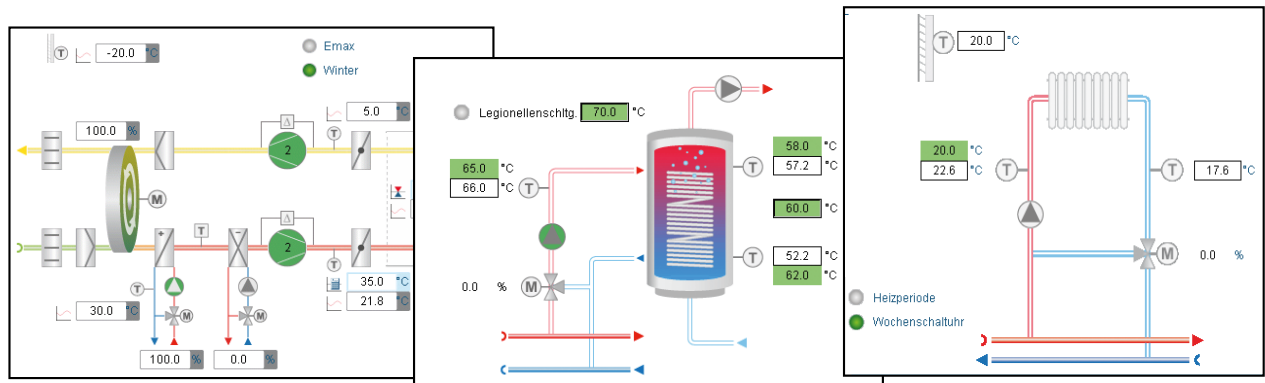

System schematic

### 1.1.3.2 Example application of the DDC Suite

In the previous example it was made clear how quickly and easily the implementation of an HVAC system can be performed with the correct engineering tool. The engineering time can, however, be further reduced using the DDC Suite.

#### Engineering start

After the hardware settings (Device Configurator), a new program file (Fupla file) is created. The implementation of a system can now begin. Various templates are provided so that the creation of a new HVAC system does not have to start again from the very beginning. After clicking on the "Template" symbol in the Fupla Selector, the available templates are listed.

→ Selecting templates: In this example, the template AirCond\_T1 is used.

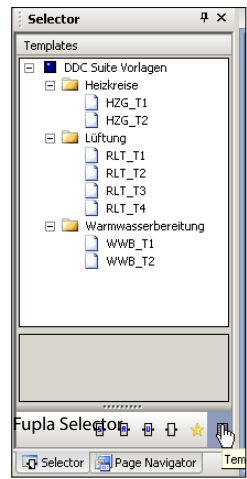

#### Adjusting the template pages

Most functions, settings and parameters can be set online. In the event of a function change, this means that the program is not normally recompiled and loaded into the controller. Thus, for example, the setpoint adjuster can easily be disabled if required the operator so desires or if the setpoint is to be used without any summer compensation. This reduces the commissioning time.

The template pages can also be adjusted with further FBoxes if required.

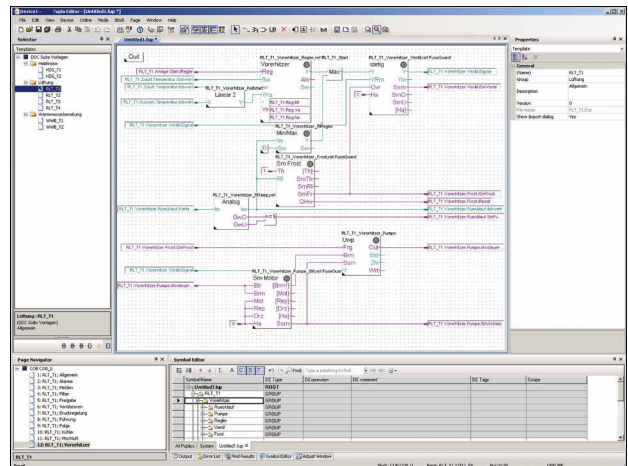

The AirCond\_T1 template contains the FBoxes and links visible here.

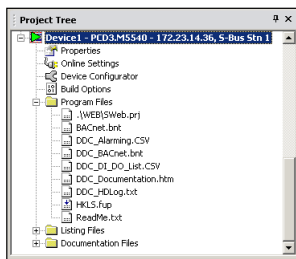

Project Tree with Program Files

#### Generating a program

As soon as the program is generated information is created automatically.

- BACnet configuration has been created (BACnet.bnt)
- Alarms with numbers and text are listed in a CSV file (DDC\_Alarming.CSV)
- Documentation as an HTML file with settings is created (DDC\_Dokumentation.htm)
- List of all parameterized historical data (DDC\_HDLog.txt)

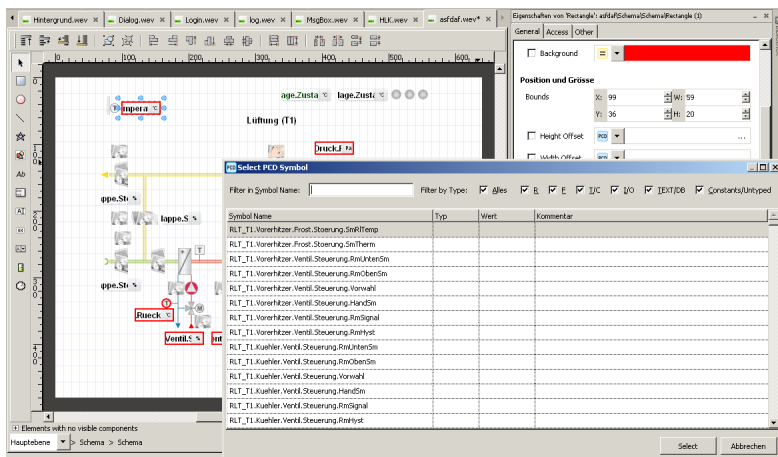

Linking symbols

#### Visualization

In the Web Editor, the template must be linked to the Fupla page with just a few clicks.

Unlike the standard HVAC FBoxes, the symbolic parameter assignments in the FBoxes are not defined as arrays: Each individual parameter can and/or must be given its own symbolic assignment if a connection to a display or a building automation system is required. This assignment is no longer needed for the DDC Suite library since all parameters already contain symbolic assignments. Thus the assignment to an image in the Web Editor is very quick.

## 1.1.4 Saia PG5® Controls Suite

### 1.1.4.1 My Controls Suite

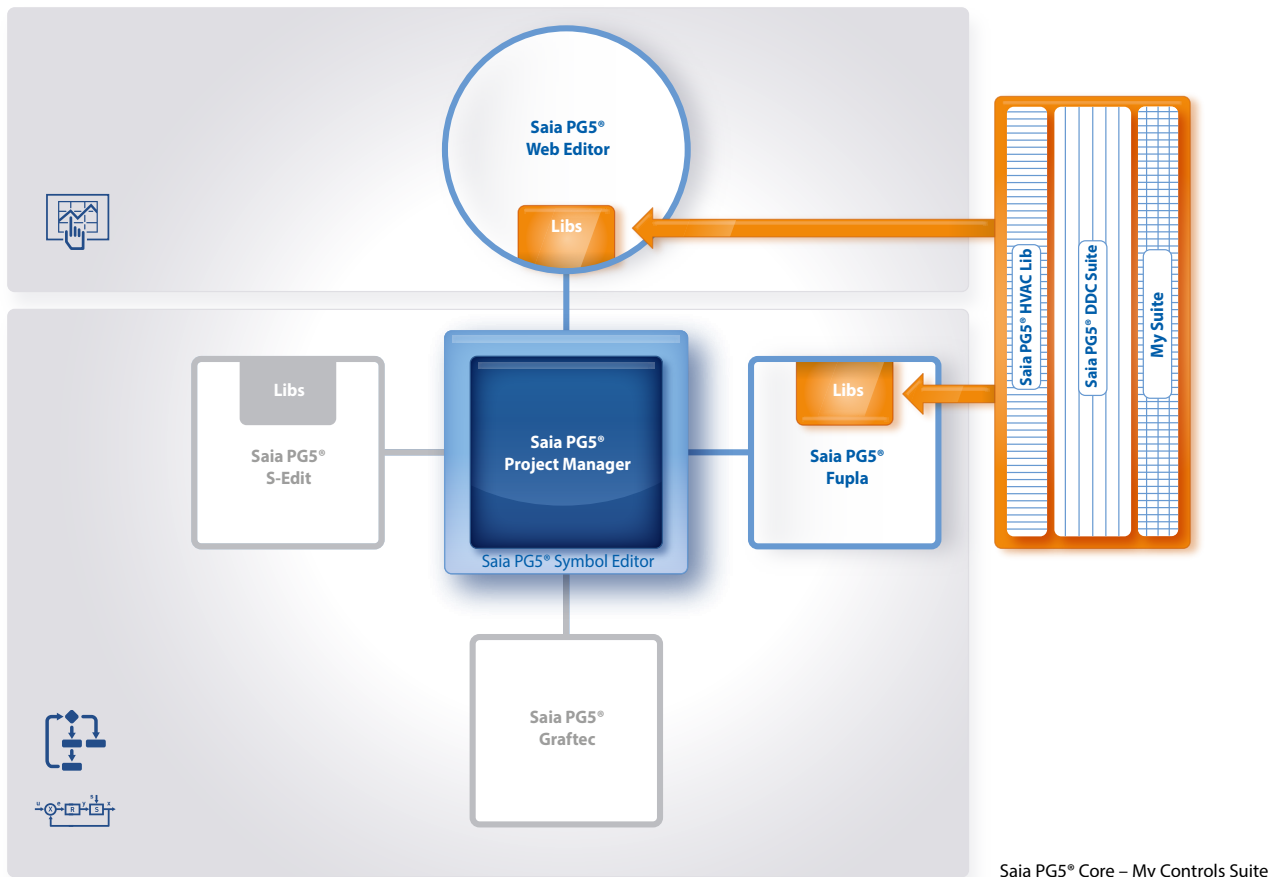

The use of predefined FBoxes and/or templates is not mandatory.

Saia PG5® Core enables individual templates to be created and even offers the opportunity to define these templates with purely graphical engineering, without any IL programming.

#### Creating templates

Using templates significantly simplifies processes and reduces engineering time. In order to implement projects more efficiently, it is not only possible to use existing templates, but also user-specific engineering projects as templates. Users who have built their standard Fupla pages can export and save them as .fxp files (a .fxp file includes any number of Fupla pages). To reuse the pages, the .fxp files must be located and then imported.

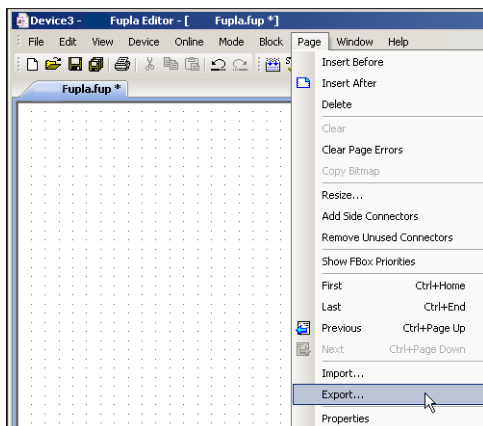

Creating templates

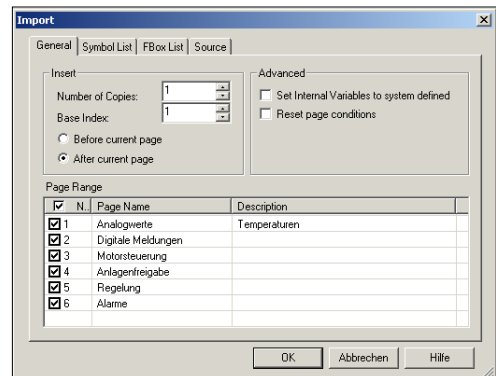

Using template pages

In addition to the templates which can be easily created and reused, it is also possible to create your own FBoxes and/or your own FBox library (My FBox Lib). The FBox Builder, which can be found in the Saia PG5® Core, is used for this.



## Creating FBoxes

The process of exporting Fupla pages and then reimporting them is simplified by the Saia PG5® FBox Builder. Users can import their .fpx files into the FBox Builder and then archive them as FBoxes.

This function (importing Fupla export pages/files) enables a structured group of FBoxes to be grouped into one large macro FBox. The Saia PG5® FBox Builder can then be used to document, maintain and export the new macro FBox as a new "product".

This capability allows custom libraries to be built up for any other use. The FBox Builder gives the user the chance to develop his own FBoxes without writing a single line of instruction list code.

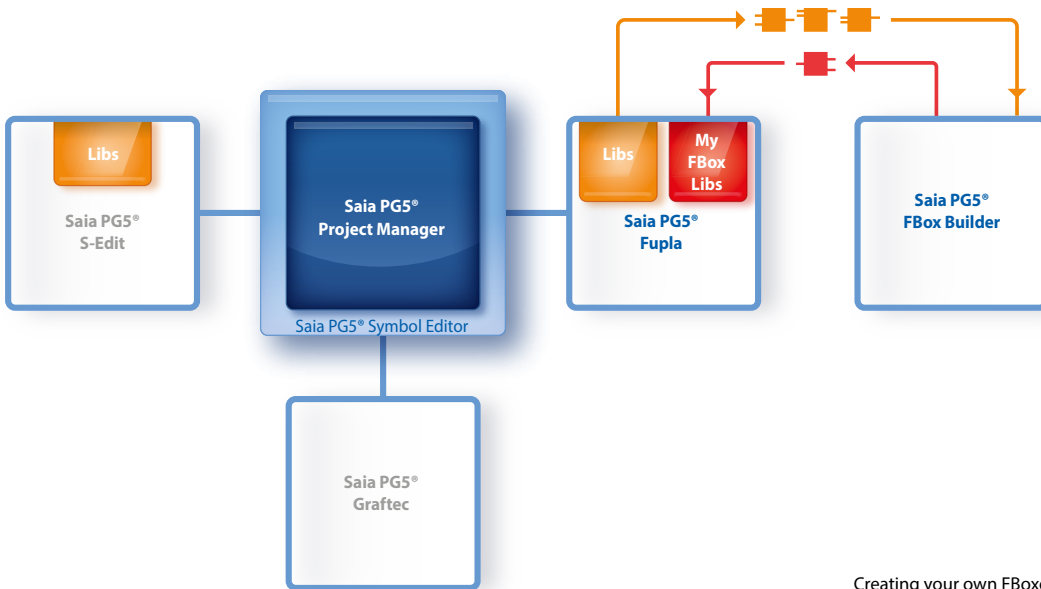

Creating your own FBoxes with the FBox Builder

The Saia PG5® FBox Builder has further additional functions which enable programmers to develop completely new FBoxes and to maintain them in their own library. The FBox Builder advanced version is needed if the user wishes to integrate existing IL functions, or modify existing FBoxes, or even create completely new FBoxes. In addition to importing export pages (1), this version enables extensive functions such as:

- Importing existing FBoxes (2)
- Creating FBoxes "from scratch" (3)
- Importing IL code (4)

The advanced FBox Builder is suitable for experienced Saia PG5® IL programmers who have attended a workshop and who have a license for the FBox Builder Advanced add-on tools.

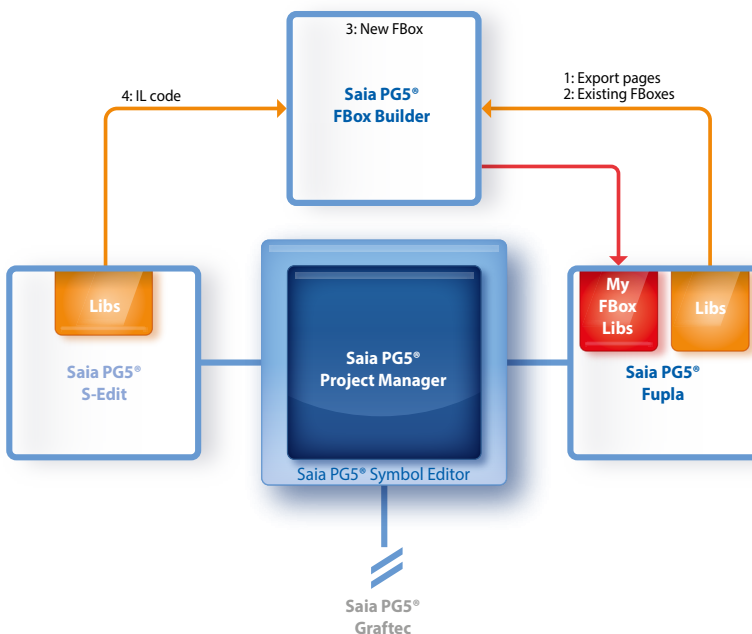

Using the Saia PG5® FBox Builder in projects with the Saia PG5® software technology

### 1.1.4.2 Web Editor as a stand-alone tool

#### Saia PG5® Web Editor – Web visualization for automation

The Saia PG5® Web Editor produces appealing web visualizations without any web designer skills.

The tool is based on the automation environment. Areas of use include system/machine visualizations, alarming and trending functions, or one service page. The full integration into the Saia PG5® Core, in conjunction with Saia PCD® controllers, guarantees a particularly efficient working method.

► A stand-alone variant is also provided for applications independent of Saia PCD® controllers.

#### Stand-alone variant

The Web Editor is independent software which can be used without the Saia PG5® Core.



#### Using the stand-alone variant

The stand-alone variant of the Web Editor can, for example, be used to individually design the S-Monitoring Application. The functionality of the off-the-shelf solution (S-Energy Monitor) is based on standard SBC technologies, in the form of a Saia PG5® Web Editor project. In practical terms, the user interface for the S-Monitoring Application can be flexibly customized using the Saia PG5® Web Editor. The 'look and feel' and the functionality can then be tailored to the individual user, to include the company design/logo for example.

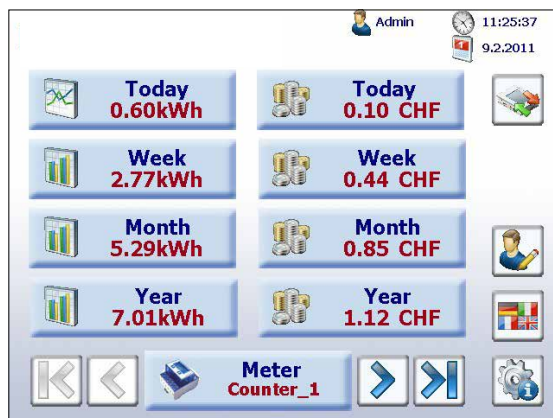



S-Monitoring Application user interface – Predefined web pages, produced with Saia Web Editor

### 1.1.4.3 Overview of the tools and license packages

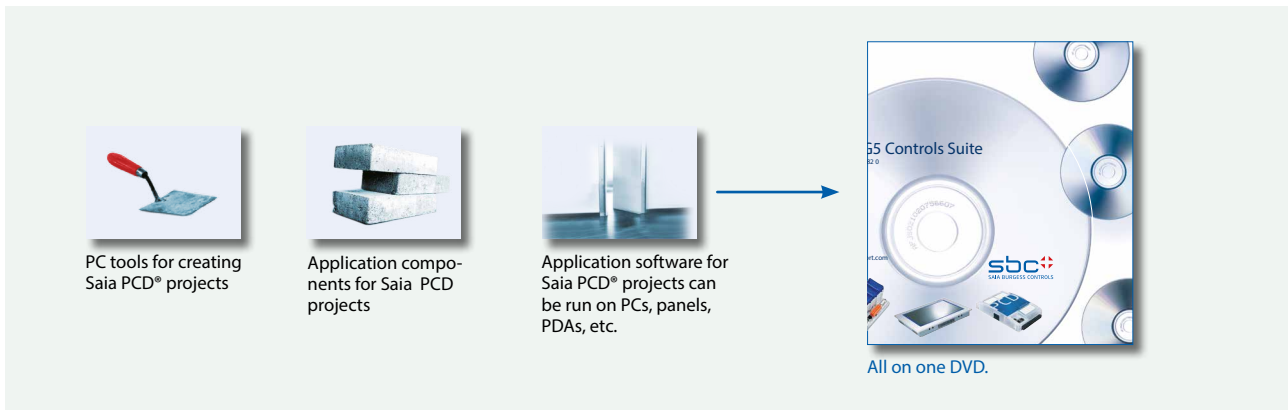
The combined platform of the SBC software is the Saia PG5® Controls Suite DVD. This includes software tools for project configuration, engineering, programming and service. The DVD also includes application components with which you can increase your productivity when using Saia PCD® products. You will also find a wide range of system software on the Saia PG5® Controls Suite DVD. This predominantly involves driver software which simply and reliably ensures the integration into a system environment.



#### Saia PG5® Controls Suite contains everything you need for automation

		
PC tools	Application components	Application software
<p><b>Saia PG5® Core Project Manager</b></p> <ul style="list-style-type: none"> <li>➤ Application Programming</li> <li>➤ Application Engineering</li> <li>➤ Network Management</li> <li>➤ Service</li> </ul> <p><b>Saia PG5® Web Editor</b> Tool for creating web pages for the Saia PCD® Web Server</p> <p><b>Saia Visi.Plus</b> Visualization and management software for applications in infrastructure automation</p> <p><b>Saia HMI Editor</b> Tool for Saia PCD® Text Panels</p> <p><b>Saia PG5® FBox Builder</b> Tool for creating and managing Saia PG5® Fupla FBoxes</p> <p><b>Saia PG5® Online-Tools</b> Downloading PG5 programs without installing the Saia PG5® Core</p>	<p><b>Standard FBoxes</b> Program modules for Saia PG5® Fupla, the graphical engineering tool</p> <ul style="list-style-type: none"> <li>➤ Arithmetic and logical FBoxes</li> <li>➤ Analog FBoxes</li> <li>➤ Communication FBoxes</li> </ul> <p><b>Application FBoxes</b> Program modules for Saia PG5® Fupla, the graphical engineering tool.</p> <p>FBoxes: Alarm, DALI, DDC Suite, EIB, Energy Meter, EnOcean, Historical Data Capture, HVAC, Blinds/Lighting, JCI N2-Bus, E-Mail Communication, LON, Modbus, Modem, MP-Bus, Room Controller</p> <p><b>IL libraries</b> Function blocks for counter modules, drive modules and analog modules can be integrated into IL programs</p>	<p><b>SBC Web Connect</b> The PC program enables access to the PCD WebServer via any communication interface (RS-232, RS-485, Profibus, Ethernet, etc.)</p> <p><b>Saia PG5® SD Flash Explorer</b> With SD Flash Explorer, the content of the SBC File System can be extracted to the PC.</p> <p><b>SBC.Net Suite</b> Simple integration of SBC automation components into Windows applications</p>
List of tools in the Saia PG5® Controls Suite		

## License packages

We have defined three packages as a global standard out of the large variety of possible software combinations with the Saia PG5® Controls Suite. The training programs, online training and documentation are based on these.

### ► Saia PG5® Core Package

With this package, all types of ICA tasks can be initiated on machines and systems. The graphical application components supplied support the use of the Saia PCD® Automation Server (Web + IT) and simple calculation and logic functions.

### ► Saia PG5® HVAC Package

In addition to the Saia PG5® Core Package, further collections of graphical control modules (FBoxes) are included which are oriented to the needs of HVAC primary systems. Template pages can be created from the basic collection of HVAC ICA modules which map any kind of system configuration.

### ► Saia PG5® Extended Package

In addition to the Saia PG5® HVAC Package, highly integrated graphical modules (DDC Suite) are included as well as a collection of templates which map the current system design of the HVAC technology.

→ For details see order information

Saia PG5® options – Add-on libraries: Tool is separated from libs. The FBox libraries can also be ordered.

The three standard packages can only be differentiated by the licensed application components (FBoxes, templates); the Saia PG5® Core always remains identical.

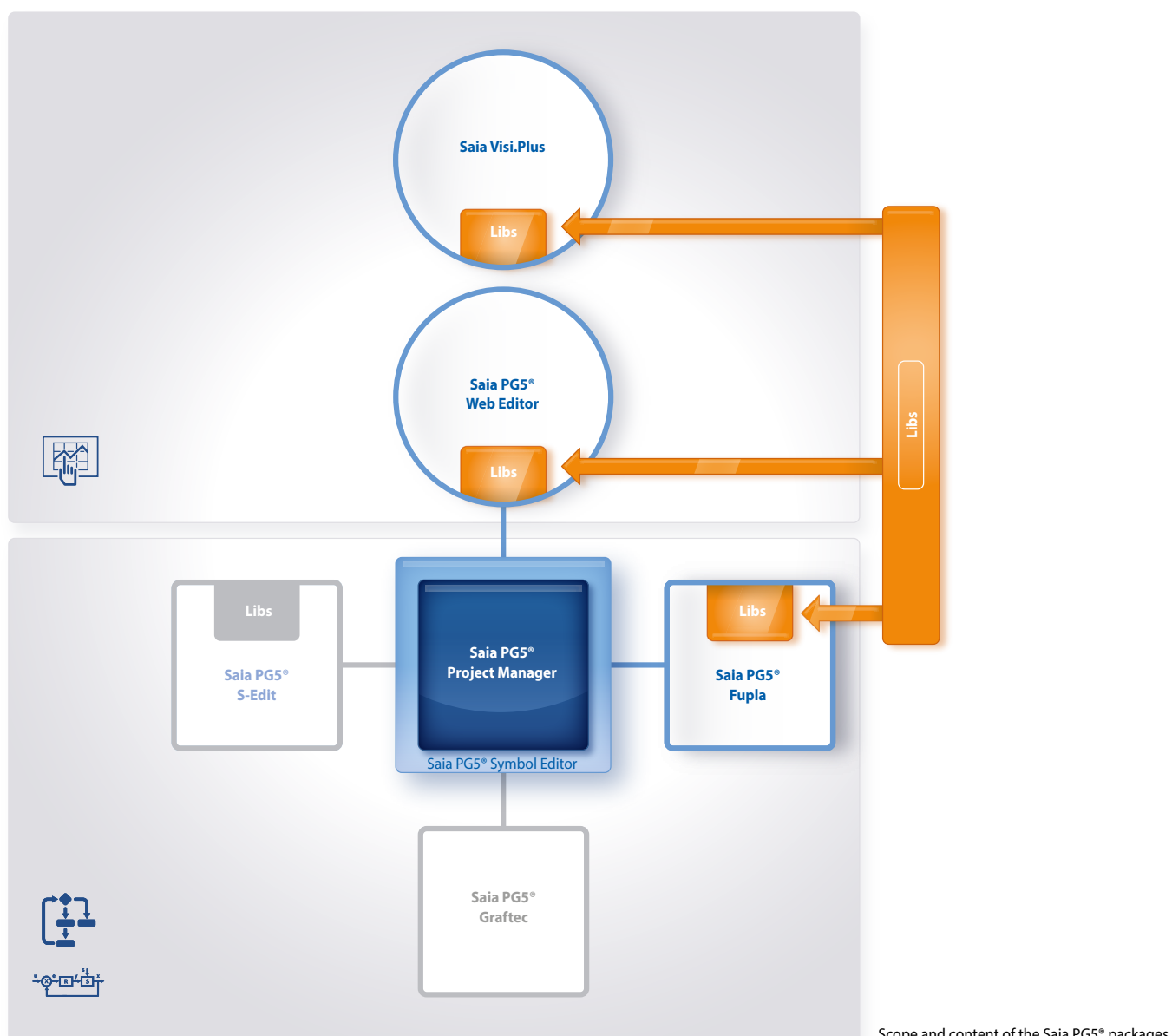

## Order information| Saia PG5® Controls Suite

### Saia PG5® programming tool

PG5 – Demo version with all functions. Runtime limited to 90 days	PCD8.PG5-DEMO
<b>Saia PG5® Core Package<sup>1)</sup></b> Programming software with editors (IL, Fupla, Graftec), network configurators, standard libraries (Analog, Communication, Arithmetic & Logic), application libraries (Alarming, Blinds-Lighting, E-Mail, Trending [HDLog], Energy Meter, DALI, Modbus, EIB, EnOcean, JCI N2-Bus), Web Editor and FBox Builder (basic version)	PCD8.PG5-CORE
<b>Saia PG5® HVAC Package<sup>1)</sup></b> Same as Saia PG5® Core Package and associated libraries (HVAC, Belimo MP-Bus, LONWORKS, Room controllers and Modem), BACnet	PCD8.PG5-HVAC
<b>Saia PG5® Extended Package<sup>1)</sup></b> Same as Saia PG5® HVAC Package and associated DDC Suite library	PCD8.PG5-EXTEND
<b>Software upgrade</b> Upgrade – according to customer's key	PCD8.PG5-UPGRDE
<b>End customer license for Saia PG5®</b> End customer license for PG5. The customer is supported by the requisitioner (according to customer's key)	PCD8.PG5-ENDUSER

### Saia PG5® options – Add-on libraries

<b>PG5 – Modem Library</b> Modem base library incl. Data Buffer, DTMF, Pager & SMS libraries	PCD8.PG5-LIBMODEM
<b>PG5 – HVAC Library</b> HVAC Library for building automation	PCD8.PG5-LIBHVAC
<b>PG5 – DDC Suite Library</b> DDC Suite Library for building automation	PCD8.PG5-LIBDDC
<b>PG5 – Belimo MP-Bus Library</b> Library for Belimo MP-Bus	PCD8.PG5-LIBMPBUS
<b>PG5 – Room Controller</b> Library for room control units	PCD8.PG5-LIBROOM
<b>PG5 – Lon</b> Library for LONWORKS®	PCD8.PG5-LIBLON

### Saia PG5® options – Add-on tools

<b>PG5 – Web Editor</b> Software package for Saia PG5® Web Editor as a stand-alone tool	PCD8.PG5-WEB8-SA
<b>PG5 – FBox Builder</b> (“advanced version”) Software package for Saia PG5® FBox Builder. IL knowledge needed and 1 day's training included	PCD8.PG5-FBOXBLD

## 1.2 Application software for Windows PCs

### 1.2.1 Saia Visi.Plus | Classic control/management system

Software package for visualization and management tasks – for reliable, efficient and cost-effective project implementation in connection with Saia automation systems and DDC Suite.

#### Main characteristics of Saia Visi.Plus

- Optimally integrated and adjusted to Saia PG5® and Saia PCD®, successfully used worldwide since 2001
- Reduced commissioning and maintenance costs, due to clear handling and freely available Engineering Edition
- The integrated web server allows all process data to be displayed with a web browser at no additional cost



The open philosophy of the Saia PCD® is also consistently implemented in Visi.Plus. Interfaces to all current applications are either already integrated or accessible later.

The Visi.Plus management system is successfully used in a very wide range of areas

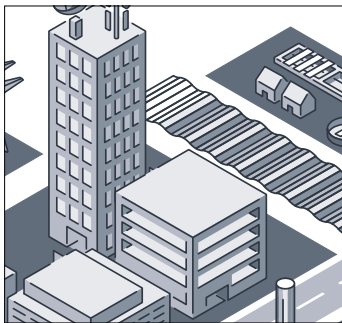

**Building technology**  
Visi.Plus is represented in buildings for all uses:

- Shopping malls
- Hospitals
- Office buildings

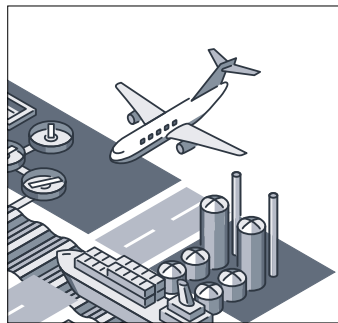

**Traffic engineering**  
Visi.Plus is designed for traffic tasks:

- Tunnels (train/car)
- Airports
- Point heating

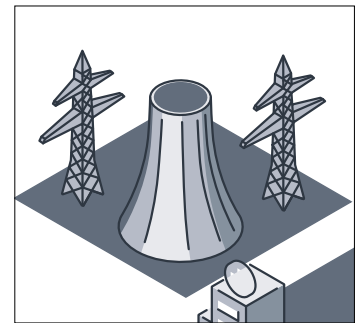

**Power engineering**  
Visi.Plus distributes and reliably measures heating and energy data:

- Combined heat and power plants
- Energy measuring servers
- Solar plants



## Engineering Edition – Saia Visi.Plus

Visi.Plus provides support at the start of the project and performs valuable services which save time and money. The Engineering Edition is included in Saia PG5 Core and can be used for commissioning and optimization. The runtime management system is activated by the acquisition of a license, all operating images and settings are taken over automatically. Thanks to the DDC Suite and a few mouse clicks, the following functions are available immediately:



### Alarming

- Alarm list incl. history
- Forwarding via e-mail or SMS
- Control for end customers



### Control panels

- Complete system overview
- Simple configuration
- Optimization through visualization



### Trends

- Recording closed loops
- Controlling optimizations
- Confirmation for end customers



### Web

- Remote access possible immediately
- Support according to putting into operation
- Control by planner/end customer

### Visi.Plus as a tool for commissioning and optimization

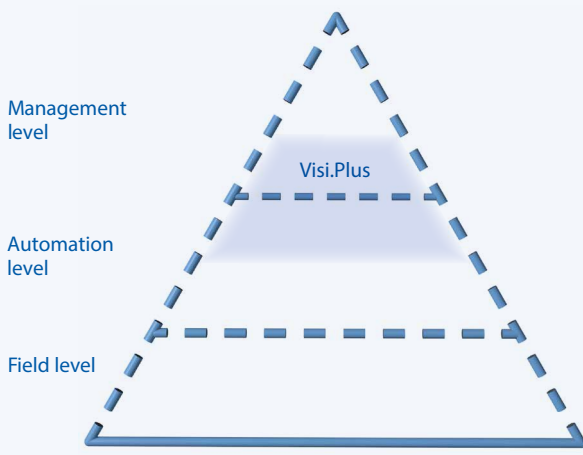

#### Benefits of Visi.Plus to assist with commissioning/optimization

- Immediate overview of trend and alarming data
- Development environment included in Saia PG5® and fully functional
- Easy control of all parameters and regulation systems



Runtime license

A small step for the integrator – huge benefits for the operator

### Visi.Plus as a complete management system

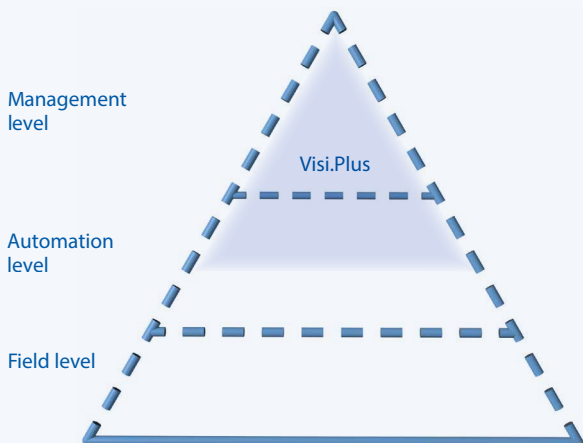

#### Benefits of Visi.Plus as a management system

- Open structure for connecting to standard systems (OPC, BACnet, Modbus, SQL, MS Office)
- Scalable architecture, for price optimization across a broad spectrum of use
- Optimally integrated and dedicated to Saia PG5® and Saia PCD®



# Database systems

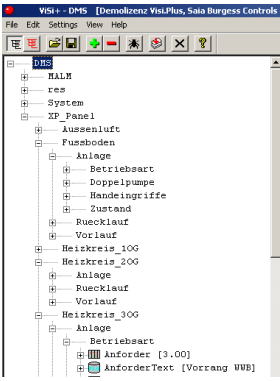

## Run-time database system (DMS)

The data management system is the central database of the entire system. All process data is managed in the DMS and is available at all times. Communication with the individual program parts (e.g. the graphical editor) is event-oriented.

## Long-term database system (PDBS)

The database system stores and manages history data, alarms and logs. This module also allows data to be exported to other databases, enabling process data to be collected in real time and stored in different databases.

DMS name	Address	Comment	Type	Value	PLC	Alarm	History (MAlarm)
1110	PLC1	(5) Dampfer Stellung RL	FLT	1.000	S-Bus_USB R1		
1111	PLC1	(5) Auswert des Norms	OFF	0.000	S-Bus_USB R0		
1112	PLC1	(5) Vorwärt des S-Bus	OFF	0.000	S-Bus_USB R0		
1113	PLC1	(5) Steuerung P1-5	BIT	OFF	S-Bus_USB R0	Alarm	DB-Tab
1114	PLC1	(5) Dampfer Stellung RL	FLT	1.000	S-Bus_USB R1		
1115	PLC1	PLC-Status vorname	INT	0.000	S-Bus_USB R1		
1116	PLC1	(5) Auswert des Norms	FLT	4.000	S-Bus_USB R1		

## Process Engineering Tool (PET)

The PET provides a convenient and clear representation of all data from the data management system in tabular form. All data (incl. communication, alarming, logging, functions, etc.) belonging to a project can therefore be created and managed in the Process Engineering Tool.

# Communication drivers

DMS-Name	DMS-Wert	SPS-Wert	SPS-Beschrift
CyCenter-H2S-Nord-Auswert-Temperatur-Push...	1.00	10	R-0101
CyCenter-H2S-Nord-Ruecklauf-Temperatur-Push...	1.00	10	R-0101
CyCenter-H2S-Mittel-Nord-Temperatur-Push...	9.30	93	R-0102
CyCenter-H2S-Sued-Auswert-Temperatur-Push...	1.00	10	R-0103
CyCenter-H2S-Sued-Ruecklauf-Temperatur-Push...	1.00	10	R-0104
CyCenter-H2S-Sued-Nord-Temperatur-Push...	9.30	93	R-0105
CyCenter-Kino-AdP-Durch-Fluehler-Dampfer...	11.30	113	R-0106
CyCenter-Kino-AdP-Temperatur-Push...	1.00	10	R-0107
CyCenter-Kino-Auswert-Temperatur-Push...	1.00	10	R-0108
CyCenter-Kino-Auswert-Temperatur-Druck-Sens...	3.50	42967.000	R-0109
CyCenter-Kino-Auswert-Temperatur-Fluehler...	1.00	10	R-0110
CyCenter-Kino-Auswert-Temperatur-Fluehler...	1.00	10	R-0111
CyCenter-Kino-Auswert-Temperatur-Fluehler...	22.10	221	R-0112
CyCenter-Kino-Auswert-Temperatur-Fluehler...	1.30	13	R-0113
CyCenter-Kino-Auswert-Temperatur-Fluehler...	9.30	93	R-0114
CyCenter-Kino-Auswert-Temperatur-Fluehler...	9.30	93	R-0115
CyCenter-Kino-Auswert-Temperatur-Fluehler...	9.30	93	R-0116
CyCenter-Kino-Auswert-Temperatur-Fluehler...	9.30	93	R-0117
CyCenter-Kino-Auswert-Temperatur-Fluehler...	9.30	93	R-0118
CyCenter-Kino-Auswert-Temperatur-Fluehler...	1.00	10	R-0119
CyCenter-H2S-Mittel-Nord-Temperatur-Push...	9.30	93	R-0120
CyCenter-H2S-Sued-Nord-Temperatur-Push...	1.00	10	R-0121
CyCenter-Kino-AdP-Durch-Fluehler-Dampfer...	9.30	93	R-0122
CyCenter-Kino-AdP-Temperatur-Push...	11.30	113	R-0123
CyCenter-Kino-Auswert-Temperatur-Push...	9.30	93	R-0124
CyCenter-Kino-Auswert-Temperatur-Push...	9.30	93	R-0125

## The S-Driver

The S-Driver is used for communication with SBC automation stations based on the S-Bus protocol. The driver supports all types of communication, e.g. serial interface, modem, USB and TCP/IP. Because the S-Driver is based on SBC's own SCOMM-DLL, all PG5 tools can be used in parallel with it. The S-Driver has a mechanism to optimize data traffic using automatically generated telegram packets. A further optimization is achieved by prioritizing telegrams according to categories, such as alarms, actual values, or setpoints.

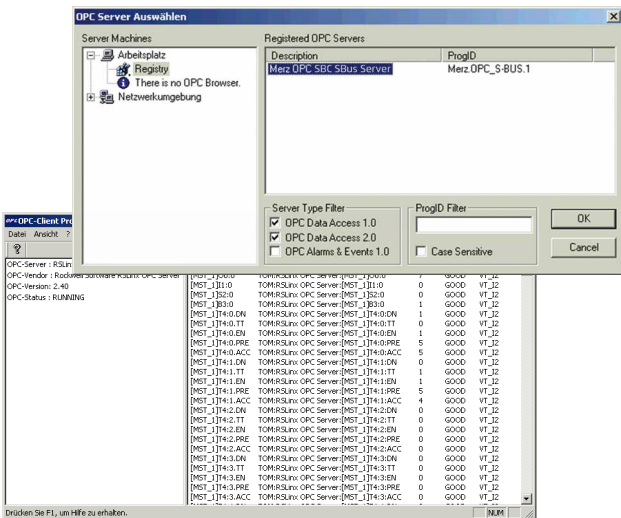

## Visi.Plus as OPC client

To enable the neutral integration of automation systems even from other manufacturers, Visi.Plus offers an OPC client that reads data from the OPC Server of a third-party supplier and automatically enters it in the Visi.Plus DMS database. The user can then access it for further processing in the Graphical Editor or Alarm Manager, or for storage in the history database.

1 SBC Software

2 Communication & Interaction

3 SBC S-Web technology

## Add-on programs

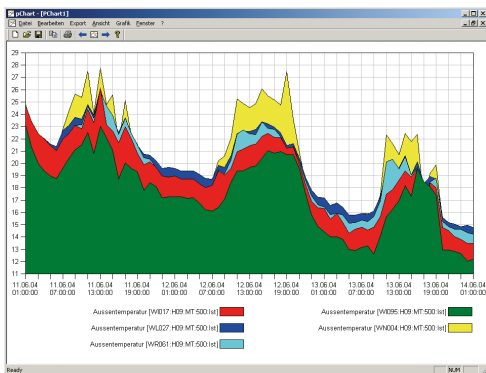

### ▲ Analysis of trend data (PChart)

If the user wishes to display or export trends, however they have been compiled, PChart is the tool to use. The trend data can be displayed in a variety of colors and different scales.

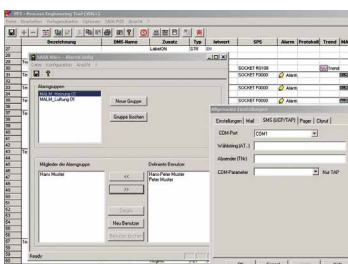

### Mobile Alarm (MALM)

Remote alarms via email/SMS.

When monitoring technical building installations it is necessary to guarantee that, in the absence of service personnel, fault messages are forwarded quickly and safely. Direct diagnosis of the fault message is also possible via remote dial-in, thus avoiding unnecessary journeys by service personnel. The alarm is sent via SMS or email.

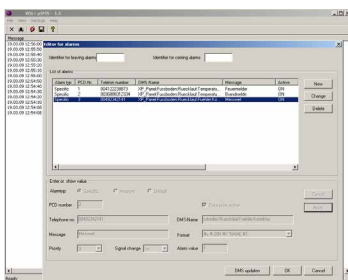

### ▲ MALM Voice

When an alarm occurs, a voicemail message (sound file in WAV format) can be played back via telephone. The person called can then use the same call to acknowledge the alarm by entering a sequence of numbers (requires a DTMF-enabled telephone).

### pCalc

Calculations for energy analysis and system monitoring, up to 1,000 formulas with 16 variables each.

## System requirements

Visi.Plus requires the following as a minimum:

- ▶ Windows 2000, Windows XP, Windows XP Embedded, Windows Vista, Windows 7 (32 / 64-bit versions)
- ▶ Windows Server 2003, Windows Server 2008 (32 / 64-bit versions)

### MALM ESPA 4.4.4

With this module, alarms can be forwarded to telecommunications systems with an ESPA 4.4.4 interface (serial, type RS-232), to be output to the display of a telephone within the local telephone network.

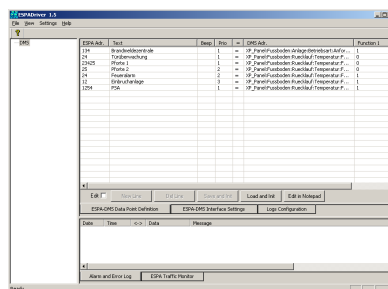

### ▲ ESPA 4.4.4 (RCV)

Messages transmitted by telecommunications systems with an ESPA 4.4.4 interface (serial, type RS-232) can be implemented as alarm messages by Visi.Plus and used for further processing and logging.

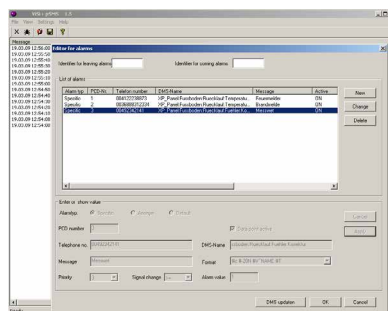

### ▲ pSMS

With a GSM-compatible modem (not included), SMS messages can be received and their content assessed according to a specification (e.g. to acknowledge alarms or modify values).

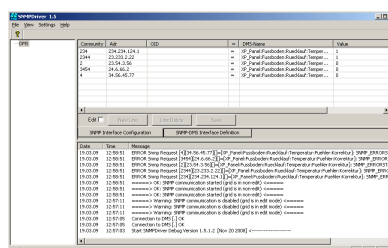

### ▲ SNMP Manager

Driver to monitor network components that provide SNMP services, such as routers or controllers. The values polled (depending on parameters set) are integrated into the Visi.Plus database, where they can be processed further (e.g. for history data or alarms).

- ▶ Pentium 1 GHz PC
- ▶ 512 MB RAM (the higher the number of DMS data points, the more memory that is required)
- ▶ Hard disk with at least 60 MB free memory (for the installation)
- ▶ CD-ROM drive (poss. external data backup (CD writer))

## Order information | Saia Visi.Plus

Three basic Visi.Plus versions are available to system integrators. Depending on the job requirements and the complexity of the systems, the appropriate package for the client can be deployed and extended with add-on modules.

Type	<b>Saia Visi.Plus packages in German and English (1 license per project)</b>	
	<b>Visi.Plus Engineering Edition</b> (Engineering Edition is part of each PG5 licence)	
PCD8.VP-DEMO	<b>Visi.Plus Demo – Demo package</b>	
PCD8.VP-MINI	<b>Visi.Plus Mini – Mini package</b> Data management system, database system, graphical editor, engineering tool, scheduler program, trend and alarm capture and S-Driver for 1,000 data points (approx. 65 hardware data points)	
PCD8.VP-BASIC	<b>Visi.Plus Basic – Basic package</b> Data management system, database system, graphical editor, engineering tool, scheduler program, trend and alarm capture, MALM remote alarms via pager/SMS/e-mail, PRT access logging and S-Driver for 10,000 data points (approx. 650 hardware data points)	
PCD8.VP-STD	<b>Visi.Plus Standard – Standard package</b> Data management system, database system, graphical editor, engineering tool, scheduler program, trend and alarm capture, MALM remote alarms via pager/SMS/e-mail, PRT access logging, pChart trend displays, Web Server 2 and S-Driver for 100,000 data points (approx. 6500 hardware data points)	
PCD8.VP-UPGRADE	<b>Visi.Plus Update</b> – Version update (according to customer Visi.Plus package)	
<b>S-Driver options – Add-on for Visi.Plus packages</b>		
PPCD8.VP-SBUS10K	<b>Option for Visi.Plus packages</b> S-Driver for 10,000 additional data points (approx. 650 hardware data points)	
PCD8.VP-SBUS25K	<b>Option for Visi.Plus packages</b> S-Driver for 25,000 additional data points (approx. 1,625 hardware data points), not possible with the Mini package	
PCD8.VP-SBUS50K	<b>Option for Visi.Plus packages</b> S-Driver for 50,000 additional data points (approx. 3,250 hardware data points), not possible with the Mini package	
PCD8.VP-SBUSUL	<b>Option for Visi.Plus packages</b> S-Driver for unlimited data points, not possible with the Mini package	
<b>Module options – Add-on for Visi.Plus packages</b>		
PCD8.VP-GE2	<b>GE2 – Graphical editor</b>	Runtime system, two additional operator stations
PCD8.VP-GE5	<b>GE5 – Graphical editor</b>	Runtime system, five additional operator stations
PCD8.VP-GE10	<b>GE10 – Graphical editor</b>	Runtime system, ten additional operator stations
PCD8.VP-GEUL	<b>GEUL – Graphical editor</b>	Runtime system, unlimited operator stations
PCD8.VP-PRT	<b>PRT</b> – Access logging (included in Basic and Standard package)	
PCD8.VP-PCHART	<b>pChart</b> – Trend display tool Each user (1...10) costs one full pChart license (one user included in the Standard package)	
PCD8.VP-PCALC	<b>pCalc</b> – Calculations for energy analysis and system monitoring, up to 1,000 formulas with 16 variables each	
PCD8.VP-MALM	<b>MALM</b> – Remote alarms via pager/SMS/e-mail (included in Basic and Standard package)	
PCD8.VP-MALMVOICE	<b>MALM Voice</b> – Transmission of voice mail with acknowledgement via DTMF (add-on option for MALM)	
PCD8.VP-MALMESPA	<b>MALM ESPA 4.4.4</b> – Remote alarms (sending) via ESPA protocol (add-on option for MALM)	
PCD8.VP-ESPA	<b>ESPA 4.4.4</b> – Receive alarms and messages via ESPA protocol to Visi.Plus	
PCD8.VP-PSMS	<b>pSMS</b> – Receive and evaluate SMS via GSM modem (GSM modem is not included in the scope of delivery)	
PCD8.VP-SNMP	<b>SNMP driver</b> to monitor network components with SNMP polling	
PCD8.VP-WEB2	<b>Web Server 2</b> – for 2 additional simultaneous connections	
PCD8.VP-WEB5	<b>Web Server 5</b> – for 5 additional simultaneous connections	
PCD8.VP-WEB20	<b>Web Server 20</b> – for a maximum of 20 simultaneous connections	
<b>Other drivers</b>		
PCD8.VP-OPC1	<b>OPC1</b> – OPC client	Client for 250 data points
PCD8.VP-OPC2	<b>OPC2</b> – OPC client	Client for 1,000 data points
PCD8.VP-OPC3	<b>OPC3</b> – OPC client	Client for 10,000 data points
	<b>BACnet</b> – Driver*	

\* In preparation, see section C2 Product status

## 1.2.2 SBC.Net Suite

Standard .Net technology from Microsoft® and SBC.Net communications components provide software developers with easy ways of integrating SBC automation components into their Windows applications, without having to worry about communications drivers.

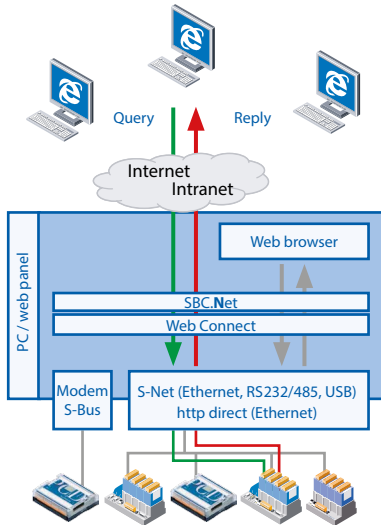

▲ Web-Connect

### Web-Connect

Web-Connect provides gateway and proxy server functions for PCs and web panels with Windows operating systems. Through the HTTP gateway function, the web servers of cost-efficient PCD controllers can be controlled without an Ethernet connection via RS-485. This access option is transparent for HTTP clients and web browsers. It makes sense to use it as a proxy server with a caching function primarily in larger web projects. Access to these projects can be speed up significantly for slower RS-485 or modem connections. The caching function can, however, also be used to speed up HTTP direct connections. The individual controllers are grouped together in station tables. The individual connections can be operated and configured via normal Internet browsers.

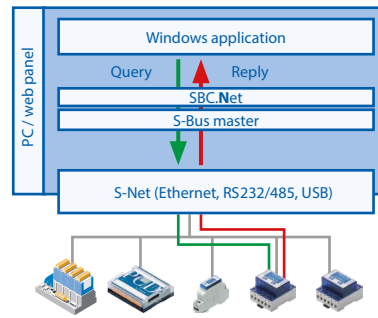

▲ S-Bus master

### S-Bus master – Efficient communication

Native communications drivers and .Net class libraries for an efficient integration of S-Bus components into Windows applications. The S-Bus master component of SBC.Net allows applications to access, read and write to PCD media. The application requires no knowledge of the protocol used. Simple programming interfaces with class libraries ensure easy integration into Windows applications. The communications driver supports the simultaneous communication with multiple controllers. Applications: Windows visualizations, reading the Saia PCD® energy meters

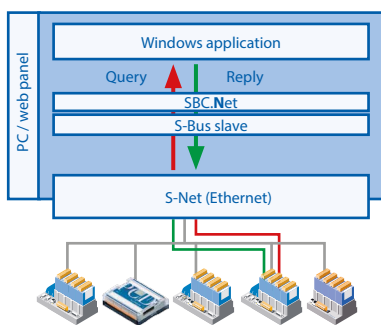

▲ S-Bus slave

### S-Bus slave – Reduction in network load

Native communications drivers and .Net class libraries for an efficient integration of S-Bus components into Windows applications. By integrating the S-Bus slave components, the application can respond to events and trigger the relevant functions and replies. Since the Windows application no longer needs to poll the individual stations, the S-Bus slave can be used to significantly reduce the network load. Applications: Event logger without polling.

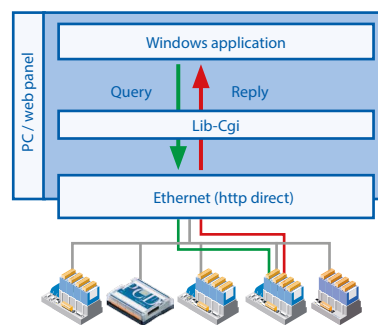

▲ LibCgi

### LibCgi – Open communication

The Microsoft .Net class library enables the simple exchange of data via the PCD web server. Windows applications can access PCD media efficiently via CGI calls via port 80. CGI calls enable Windows applications to also access (read and write) the file system of the PCD controller directly. Applications: Windows visualizations which exchange data via the Internet or Intranet networks.

#### PCD8.SBC.NETSUITE \*

Communications class libraries for programming Windows applications with components based on Microsoft.NET technology, including documentation and examples as well as access to updates for 1 year

\* In preparation, see section C2 "Product status"



## 1.2.3 SBC OPC Server

Providers of various automation systems trigger the communication between the user and automation through dedicated manufacturer-specific protocols. Each device requires its own software installation on the operator's computers/end devices. If several different devices are to be accessed with one end device, this generally requires a very complex PC installation. The consequences are as follows: Complex systems, high costs for investment and maintenance as well as limited flexibility for changes/enhancements.

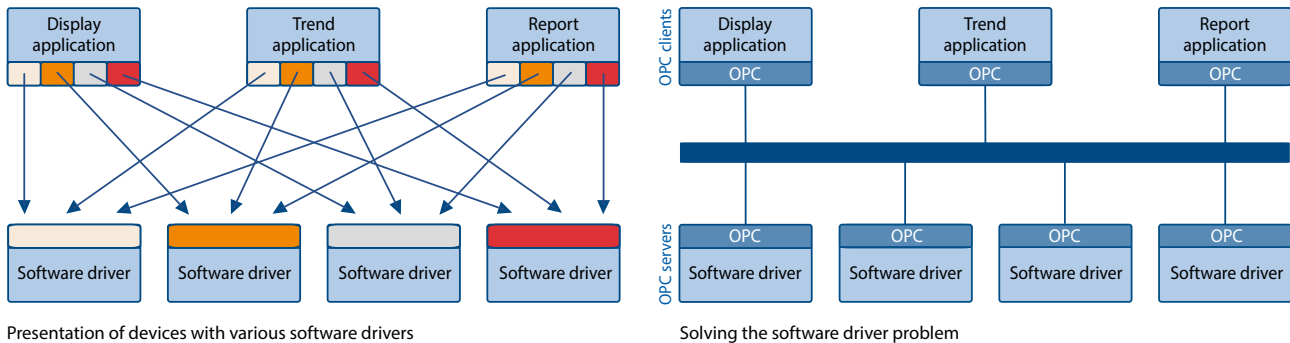

With the standardized OPC interface, expertise in manufacturer-specific protocols is no longer required. This results in significantly lower costs and effort for development, commissioning and maintenance.

### OPC servers in combination with the SBC S-Bus

- ▶ **OPC project:** All OPC data for networked controllers is brought together in a single project. This produces a clear data structure and simplifies the proper definition of data points
- ▶ **Import of PLC variables:** Symbols and data points previously defined for the PLC program with the Saia PG5® Controls Suite software tool can be carried over and used unmodified by the OPC Server. Data formats for import functions include: \*.src (PG3, PG4), \*.pcd (PG4, PG5), \*.sy5 (PG5), \*.csv (comma separated values; e.g. from Excel)
- ▶ **OPC Server / Saia PCD®:** Visualization and management systems with OPC client interfaces can be connected to any Saia PCD® controller via the OPC Server. This enables every OPC client, via the OPC Server, to read data from the PCD or write data to the PCD. PLC data that can be displayed in OPC Server includes: Inputs, outputs, flags, registers, data blocks, texts, timers, counters, date-time, display register, firmware version

#### Supported OPC data access standards

1.01a, 2.05a

#### Supported PC operating systems

MS Windows NT 4.0 SP4, MS Windows 95 / 98, Windows 2000, Windows XP, Windows Vista, Windows Server 2003, Windows Server 2008, Windows 7

#### Communication by all routes

Communication between the OPC Server and the Saia PCD® can take place via RS-232, RS-485, modem, TCP/IP, Profibus or USB. Several OPC clients can access the OPC Server simultaneously via multiple PC interfaces

#### Supported protocols

S-Bus Data, Parity and Break mode, S-Bus via UDP/IP (Ether-S-Bus), S-Bus via Profibus (Profi-S-Bus), PGU-Mode

### Order information | Saia OPC Server for SBC S-Bus

SBC OPC Server – Demo version, limited duration of 1 hour (can be downloaded free of charge at <a href="http://www.sbc-support.com">www.sbc-support.com</a> )	PCD8.OPC-DEMO
SBC OPC Server – Full version, for one PC and one application	PCD8.OPC-1
SBC OPC Server – Full version, for 3 PCs with the same application	PCD8.OPC-3
SBC OPC Server – Full version, for 5 PCs with the same application	PCD8.OPC-5
SBC OPC Server – Full version, for an unlimited number of PCs with the same application	PCD8.OPC-UL
SBC OPC Server – Full version, unlimited number of licenses for OEM	PCD8.OPC-OEM



# B2

## Communication & interaction

Saia PCD® devices can access all current paths of communication on a site. Interaction within a Saia PCD® system is inherently guaranteed (S-Net). Interacting with external devices is easy. This enables total integration with all systems and building services. It is the basis on which the full optimisation of operational efficiency and reliability is built.

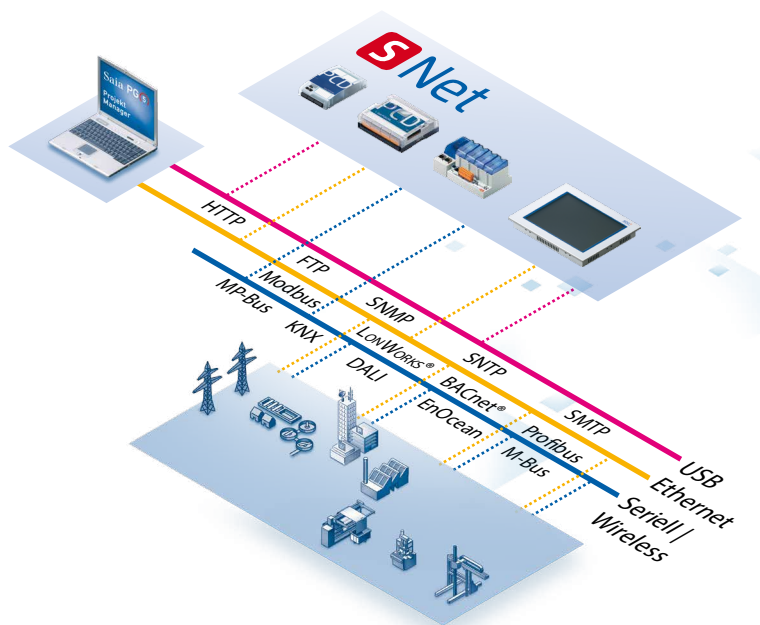

### 2.1 The basic features of Saia PCD® communications systems

Page 190

On-board protocols, communications options for extending operating systems, communication drivers in the application program, IP-based protocols, serial protocols with standard interfaces, dedicated communications systems

### 2.2 An overview of Saia PCD® communications systems

Page 192

An overview of Saia PCD® controllers with on-board interfaces and modular expansion capabilities

### 2.3 Saia Web/IT protocols

Page 194

Web and IT protocols for easy integration into the following IT architectures: DHCP, DNS, SMTP, SNMP, FTP, HTTP, ...

### 2.4 Wide Area Automation with Saia PCD®

Page 200

Protocols and services for integrating a Saia PCD® into public networks. Internet, ADSL, GSM, GPRS, UMTS, modem, ... security

### 2.5 S-Net

Page 202

#### S-Net for communicating between SBC devices

- 2.5.1 S-Net basic features
- 2.5.2 Ether-S-Net: Ether-S-Bus, Ether-S-IO
- 2.5.3 Serial-S-Net: S-Bus on serial RSxxx interfaces
- 2.5.4 Profi-S-Net: Profi-S-Bus, Profi-S-IO
- 2.5.5 Profibus

### 2.6 BA communications systems

Page 208

#### Communication standards for all building services

- 2.6.1 BACnet
- 2.6.2 Lon
- 2.6.3 Modbus
- 2.6.4 KNX/EIB
- 2.6.5 EnOcean
- 2.6.6 M-Bus
- 2.6.7 DALI
- 2.6.8 MP-Bus
- 2.6.9 Other communication drivers for connecting to external systems

## 2.1 The basic features of Saia PCD® communications systems

Saia PCD® systems provide communication protocols suitable for all layers of the automation pyramid in order to integrate a PCD into the communication infrastructure of a building. In addition to performing regulation and control tasks, the PCD is often used for connecting different systems from different building services. Irrespective of the type of interface, using only standardised communications systems is recommended for heterogeneous systems. From experience, compatibility and sustainability are better solved using standard technologies than closed solutions of a single manufacturer. The following diagram illustrates the essential differences between communications systems, from the field to the management layer.

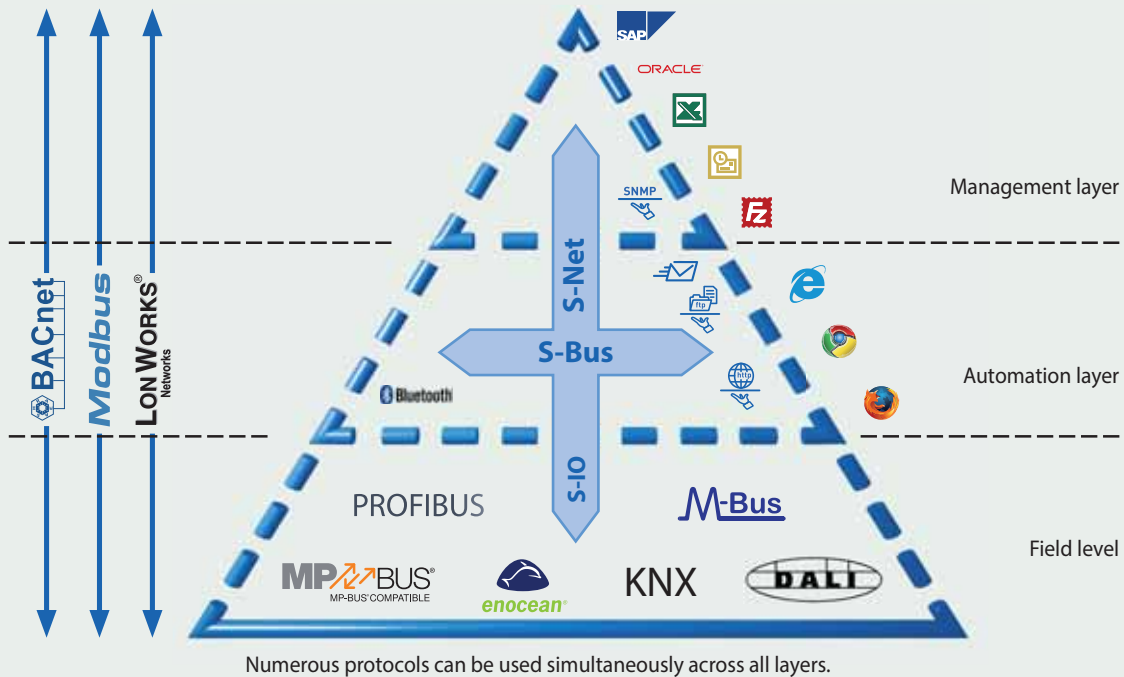

### ► IP-based protocols

IP-based protocols are mainly used for connecting controllers to management systems. IP protocols are also used to exchange data between automation devices and with local control devices. For example, BACnet is very good for communicating between automation devices and the management system. Web and IT services such as DHCP, DNS, SMTP, SNMP and SMTP (emails) have proven themselves in the integration of automation devices into the IT infrastructure. Web-based visualisations with suitable web servers and a CGI-bin interface in the automation device also provide a sustainable basis for operation and service over the entire life-cycle of a system.

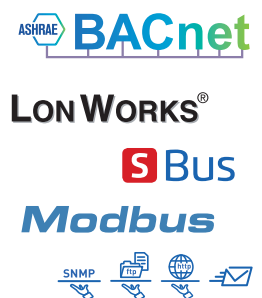

### ► Serial protocols with standard interfaces

Field components mainly use serial protocols fitted with standardised interfaces such as RS-232, RS-485 or RS-422. Despite the low baud rate, these interfaces have the advantage over Ethernet by being simple to install. The cable and infrastructure components such as repeaters are cheaper than a complete IT infrastructure. Field bus systems are also easier to service and maintain.



### ► Dedicated communications systems

For certain field devices it is practical to use a dedicated hardware interface. Such systems are optimised for a particular task. DALI is suitable for controlling lighting, for example, and M-Bus is designed for connecting meters. However, these systems should not be used for communication between automation stations.



## Saia PCD® systems

Saia PCD® systems offer solutions for almost all conventional building automation system protocols. Depending on the protocol and interface, they are already integrated in the Saia PCD® operating system, or they can be installed in the application program. Saia PCD® controllers can therefore also be used as gateways between building services which would otherwise remain separate.

### ► On-board protocols

Saia PCD® systems are based on the proprietary SBC operating system – Saia PCD® COSinus. The operating system makes certain protocols directly available, in particular Web and IT services such as S-Net. These protocols can be used on every Saia PCD® controller. Depending on the protocol, FBox libraries are available in the application program.



### ► Communication options as an operating system extension

For many protocols it is worthwhile offering them as an option, particularly when the protocols are not required globally in every application and they require a lot of memory in the controller. For example, BACnet® and LONWORKS® are available for extending the operating system. These are software components which are used as integral components of the operating system, which differentiates them from gateways.



### ► Communication drivers in the application program

At the core of every Saia PCD® is a PLC controller. The application program can be freely defined making it possible to realise a number of infrastructure automation protocols directly in the application program. This provides almost limitless flexibility.



## 2.2 An overview of Saia PCD® communications systems

	Fully modular												Compact modular					
	PCD3								RIO		PCD2		PCD1					
	PCD3.M3120	PCD3.M3230	PCD3.M3330	PCD3.M5340	PCD3.M5440	PCD3.M5540	PCD3.M5560	PCD3.M6560	PCD3.M6860	PCD3.T665	PCD3.T666	PCD2.M5440	PCD2.M5540	PCD1.M2020	PCD1.M2120	PCD1.M2160	PCD1.M0160E	PCD1.M2110R1
<b>I/O data points</b>																		
On-board (data points)	---	---	---	---	---	---	---	---	---	---	---	---	18	18	18	18	24	
On-board I/O slots <sup>1)</sup>	4	4	4	4	4	4	4	4	4	4	8	8	2	2	2	---	1	
Optional I/O slots using expansion modules <sup>1)</sup>	---	60	60	60	60	60	60	60	3	3	56	56	---	---	---	---	---	
Maximum number of I/Os <sup>1)</sup>	64	1023	1023	1023	1023	1023	1023	1023	256	256	1023	1023	50	50	50	18	40	
Maximum number of interfaces (incl. PGU, USB, Ethernet)	11	10	11	13	13	13	13	13	12	2	11	14	15	7	8	8	4	6
<b>On-board interfaces</b>																		
RS-232, PGU up to 115 kBit/s (Port #0)	---	---	---	•	•	•	•	•	---	---	•	•	---	---	---	---	---	
USB 1.1 device, PGU	•	•	•	•	•	•	•	•	•	•	•	•	•	•	•	•	•	
Ethernet TCP/IP 10/100 MBit Full duplex, autosensing/crossing	1	---	1	1	---	1	1	1	2	1	1	---	1	---	1	1	1	
RS-485 up to 115 kBit/s (Port #2) or Profi-S-Net up to 187.5 kBit/s (Port #2)	•	•	•	---	•	---	•	•	•	---	•	---	•	•	•	•	---	
RS-422/485 up to 115 kBit/s (Port #3) or RS-485 up to 115 kBit/s galvanically separated (Port #3) or Profi-DP slave, Profi-S-Net up to 1.5 MBit/s (Port #10)	---	---	---	•	•	•	•	•	---	---	•	•	---	---	---	---	---	
Profibus DP master up to 12 MBit/s	---	---	---	---	---	---	•	---	---	---	---	---	---	---	---	---	---	
<b>Optional interfaces</b>																		
Slot C, Profibus DP master 12 MBit/s	---	---	---	---	---	---	---	---	---	---	•	•	---	---	---	---	---	
BACnet® IP (with PCDx.R56x modules) <sup>2)</sup>	•	---	•	•	---	•	•	•	•	---	---	•	---	•	•	•	•	
BACnet® MS/TP <sup>3)</sup> (with PCDx.R56x and PCDx.F215x modules)	•	•	•	•	•	•	•	•	•	---	---	•	•	•	•	---	•	
Lon®-over IP (with PCDx.R58x modules) <sup>3)</sup>	•	---	•	•	---	•	•	•	•	---	---	•	---	•	•	•	•	
Modbus RTU serial or IP	•	•	•	•	•	•	•	•	•	•	•	•	•	•	•	•	•	
Slot for PCD7.F1xxS (A1/A2)	---	---	---	---	---	---	---	---	---	---	2	2	1	1	1	1	1	
<b>I/O slot #0 for PCD3.F1xx</b> ▶ RS-232 (RTS/CTS, DTR/DSR, CD, RI) <sup>5)</sup> PCD3.F121 ▶ RS-485/RS-422 galvanically connected <sup>5)</sup> PCD3.F110 ▶ RS-485/RS-422 galvanically insulated <sup>6)</sup> PCD3.F150 ▶ Belimo MP-Bus <sup>5)</sup> PCD3.F180	•	•	•	•	•	•	•	•	•	---	•	---	---	---	---	---	---	
<b>I/O slot #0... #3 for PCD3</b> ▶ PCD3.F210 RS-485/422 <sup>5)</sup> + opt. PCD7.F1xxS ▶ PCD3.F215 BACnet MS/TP... <sup>5)</sup> + opt. PCD7.F1xxS ▶ PCD3.F221 RS-232 full <sup>5)</sup> + opt. PCD7.F1xxS ▶ PCD3.F240 Lon FTT10 <sup>5)</sup> + opt. PCD7.F1xxS <sup>4)</sup> ▶ PCD3.F261 DALI incl. bus power supply <sup>5)</sup> ▶ PCD3.F27x M-Bus master <sup>5)</sup> ▶ PCD3.F281 Belimo MP-Bus <sup>5)</sup> + opt. PCD7.F1xxS	4	4	4	4	4	4	4	4	4	---	---	---	---	---	---	---	---	
<b>I/O slot #0... #3 for PCD2 and slot #0... #1 for PCD1 and</b> ▶ PCD2.F2100 RS-485/422 <sup>5)</sup> + opt. PCD7.F1xxS ▶ PCD2.F2150 BACnet MS/TP... <sup>5)</sup> + opt. PCD7.F1xxS ▶ PCD2.F2210 RS-232 full <sup>5)</sup> + opt. PCD7.F1xxS ▶ PCD2.F2400 Lon FTT10 <sup>5)</sup> + opt. PCD7.F1xxS <sup>4)</sup> ▶ PCD2.F2610 DALI incl. bus power supply <sup>5)</sup> ▶ PCD2.F27x0 M-Bus master <sup>5)</sup> ▶ PCD2.F2810 Belimo MP-Bus <sup>5)</sup> + opt. PCD7.F1xxS	---	---	---	---	---	---	---	---	---	---	4	4	2	2	2	---	1	
Slots for modem (A1/A2)	---	---	---	---	---	---	---	---	---	---	2	2	---	---	---	---	---	
Uses an external modem via RS-232 interfaces	•	•	•	•	•	•	•	•	•	---	•	•	•	•	•	•	•	



	Compact modular						Compact			
	PCD3 compact		PCD3.WAC Wide area controller				PCS1			
	PCD3.M2030V6	PCD3.M2130V6	PCD3.M2330A4T1	PCD3.M2330A4T3	PCD3.M2330A4T5	PCD3.M2230A4T3	PCS1.C42x	PCS1.C62x	PCS1.C82x	PCS1.C88x
<b>I/O data points</b>										
On-board (data points)	38	38	14	14	14	14	19	30	44	44
Optional I/O slots via expansion modules PCD3.Cxxx <sup>1)</sup>	4	4	4	4	4	4	---	---	---	---
Maximum number of I/Os <sup>1)</sup>	102	102	78	78	78	78	19	30	44	44
Maximum number of interfaces (incl. PGU)	3	4	5	5	5	4	3	3	3	4
<b>On-board interfaces</b>										
RS-232, PGU up to 115 kBit/s (Port #0)	---	---	---	---	---	---	•	•	•	•
USB 1.1 device, PGU	•	•	•	•	•	•	---	---	---	---
Ethernet TCP/IP 10/100 MBit Full duplex, autosensing	---	1	1	1	1	---	---	---	---	---
RS-485 up to 115 kBit/s (Port #2) or Profi-S-Net up to 187.5 kBit/s (Port #2)	•	•	•	•	•	•	---	---	---	---
LONWORKS® FTT10	---	---	---	---	---	---	---	---	---	•
Modem P=PSTN, I=ISDN, PCD: G=GSM/GPRS, PCS: G=GSM	---	---	P	I	G	G	P, I, G	P, I, G	P, I, G	P, I, G
<b>Optional interfaces</b>										
Modbus RTU serial or IP	•	•	•	•	•	•	---	---	---	---
Slot for PCD7.F1xxS (A1)	1	1	1	1	1	1	---	---	---	---
Uses an external modem via RS-232 interfaces	•	•	---	---	---	---	•	•	•	•



<sup>1)</sup> I/O slots can be fitted with I/O modules as required (see pages 29/30 and 48/49). The number of data points which can be processed by a PLC depends on the number of I/O data points per module. A max. of 16 data points is available per module. A PCD can therefore process a maximum number of data points of 64 I/O slots × 16 data points/slot = 1024 I/O data points.

<sup>2)</sup> A PCDx.R56x memory module is always required to use BACnet®. Controllers without Ethernet support BACnet MS/TP using optional PCD2.F2150 or PCD3.F215 communication modules.

Controller	Memory module	Max. free I/O slots
PCD3.M3xx0	PCD3.R56x	3
PCD3.M5xx0	PCD7.R56x	4
PCD2.M5xx0	PCD7.R56x	4
PCD1.M2xx0	PCD7.R56x	2
PCD1.M0xx0	PCD7.R56x	---
PCD1.Room	PCD7.R56x	1

<sup>3)</sup> It is only possible to operate BACnet®-IP and LON®-IP in parallel on the PCD3.M5560, PCD3.M6560 and PCD3.M6860 controllers.

<sup>4)</sup> The PCD2.F2400 and PCD3.F240 LON-FTT10 modules are only available on the following controllers:  
PCD1.M2020, PCD1.M2120, PCD1.M2160, PCD1.M2110R1, PCD3.M5560, PCD3.M6560, PCD3.M6860

<sup>5)</sup> Galvanically connected

<sup>6)</sup> Galvanically insulated

## 2.3 Web and IT protocols for integration into IT infrastructures

All Saia PCD® controllers have an integrated automation server with open standard Web/IT interfaces. Thanks to the standard communication protocols, Saia PCD® are easy to integrate into existing software infrastructures without additional effort. No specific drivers or systems are required. Standard tools such as web browsers, FTP clients and SNMP managers, etc., are used to access the data in the PCD controllers.

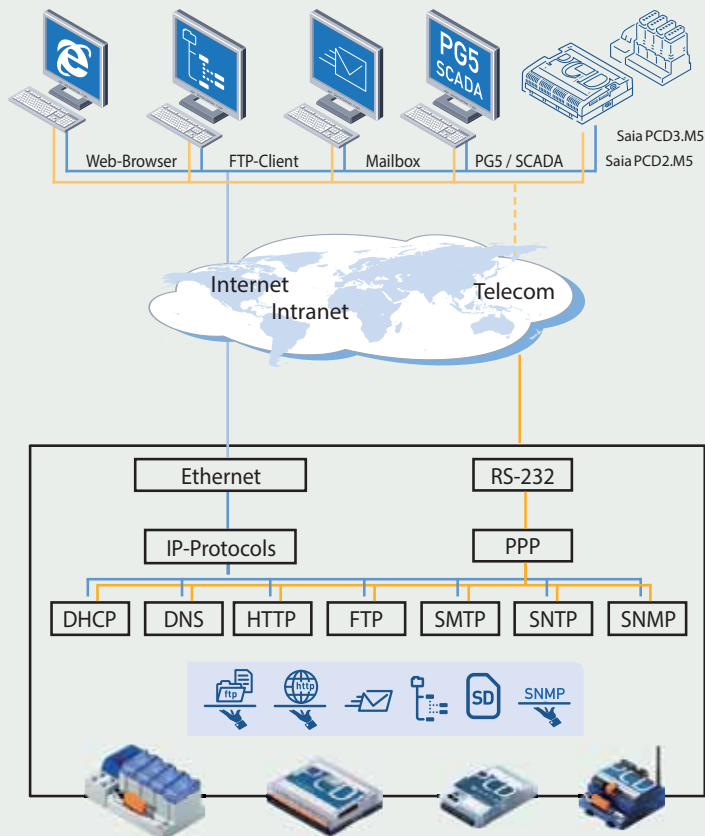

An overview of Web/IT protocols supported by the automation server. Access is provided via the Ethernet interface or via serial interfaces using the PPP protocol.

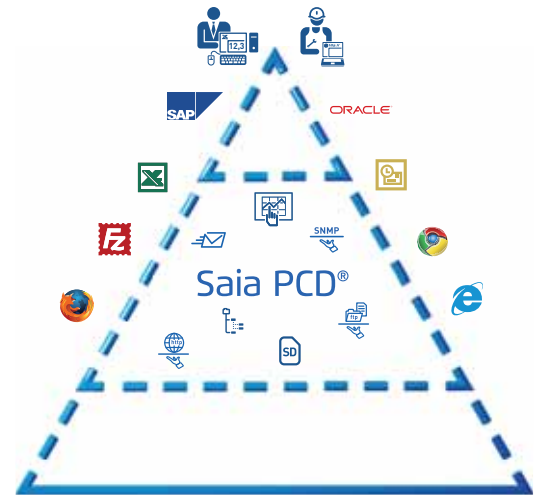

Thanks to standard Web/IT protocols, Saia PCD® systems can be universally integrated across all the layers in existing IT infrastructures without any additional effort.

### DHCP: Dynamic Host Configuration Protocol

Protocols for automatically configuring the Ethernet communication. It is no longer necessary to enter the communications parameters manually as they are assigned directly from a central server.

A DHCP client automatically receives the IP address, subnet mask, gateway and DNS address parameters on request.

The devices in the existing network are integrated automatically.

The devices are integrated in the existing network without knowledge of the network parameters. Service personnel can also exchange devices without having any technical background or knowledge of the specific network data.

<b>Standard</b>	RFC-2131
<b>Port</b>	UDP 68 for client
<b>Assigned attributes</b>	IP address Subnet mask Standard gateway (optional) DNS address (optional)

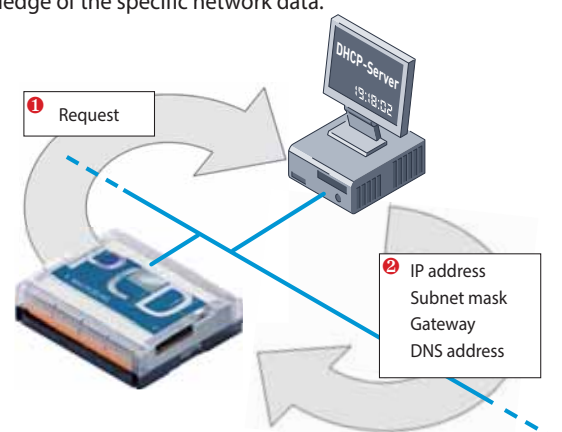

### DNS: Domain Name System

Access to the controllers via fixed naming conventions. When establishing communication between two controllers, it is not necessary to know the IP address of the target controller, only its name. The IP address can be requested from a DNS server using this name. Devices are no longer controlled via meaningless IP addresses. The structure and availability of individual networks is specified once and does not have to be constantly adjusted according to the available IP addresses. This makes systems easier and more intuitive to use. Networks involving several participants can be documented more clearly.

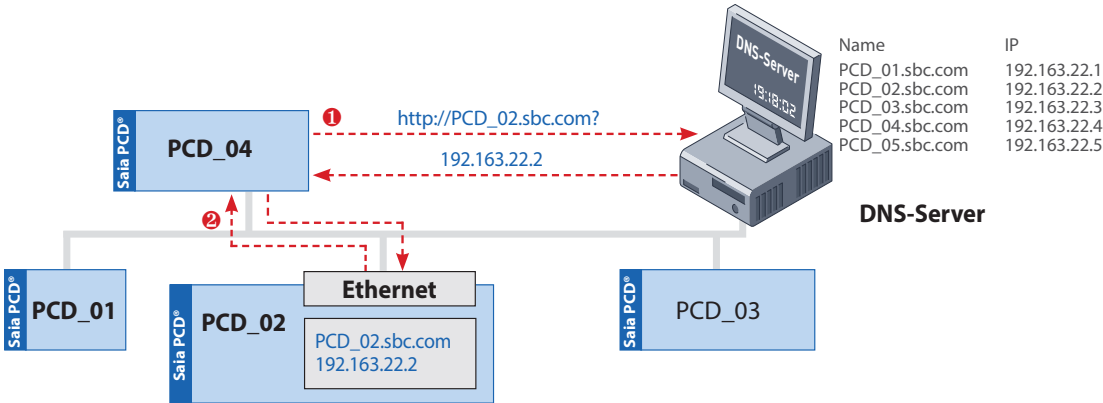

Standard	RFC-1035
Port	UDP 53

### Examples using DHCP and DNS

Integrating devices in networks is easy. A DHCP client automatically receives the network parameters from a DHCP server. This means that controllers can be integrated in existing networks without knowing the network parameters. The controller is simply accessed using the name.

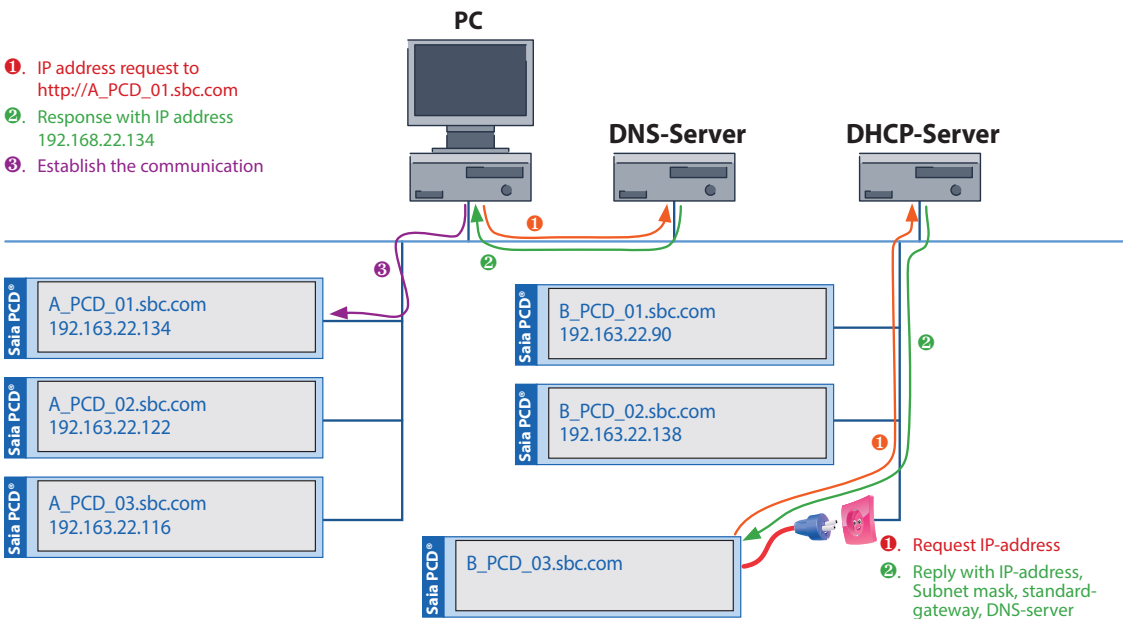

### Configuration

Basic activation and configuration of DHCP/DNS in PG5 device configurator.

DHCP Client Protocol	
DHCP Client Enabled	Yes
Automatic Gateway IP Setting	No
Automatic DNS IP Setting	No
DHCP Server IP to Reject 1	0.0.0.0
DHCP Server IP to Reject 2	0.0.0.0
Host Name	
Fully Qualified Domain Name	

DNS Client Protocol	
DNS Client Enabled	Yes
DHCP Information Enabled	No
Primary DNS Server IP Address	0.0.0.0
Secondary DNS Server IP Address	0.0.0.0
Response Timeout [ms]	1000

### FBoxes

Specific network administration FBoxes can be used to distribute the DNS names of other stations via the application program and verify communication with the PING FBox.

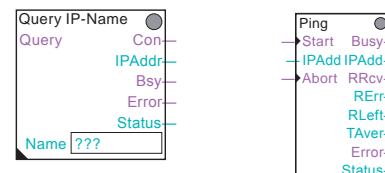

## SNTP: Simple Network Time Protocol

The Simple Network Time Protocol is a standard used to synchronise the time across several devices in IP networks. The protocol enables the transmission of the current time of servers in the Internet or Intranet. Sophisticated algorithms ensure that the different run times are balanced out across a network. The internal system clocks (RTC) and the changeovers between summertime and wintertime are synchronised automatically on all network participants at the same time.

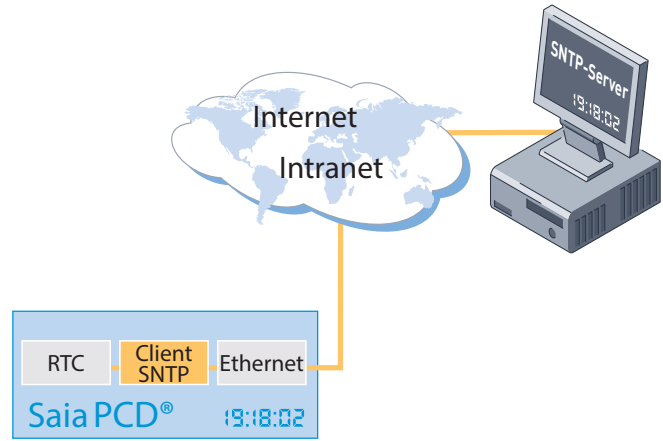

Standard	RFC-2030
Port	UDP 123
SNTP mode	Unicast Point to Point (SNTP client initiates a time request) Broadcast Point to Point (the time is sent from the NTP server simultaneously to all clients)
Time format	UTC (Greenwich Mean Time), timezone adjustable
Timing accuracy	500 ms for Unicast Point to Point 1 s for Broadcast Point to Point (without run time correction)
Request interval	10 s
Interfaces	Ethernet or serial RS-232 via PPP

### FBoxes

The status of the SNTP function can be read and/or reset using specific FBoxes.

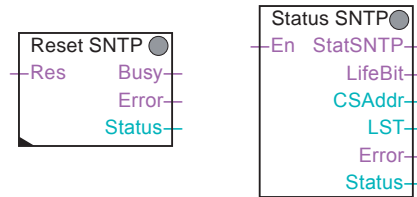

## HTTP: Protocol for accessing the PCD-Web-Server

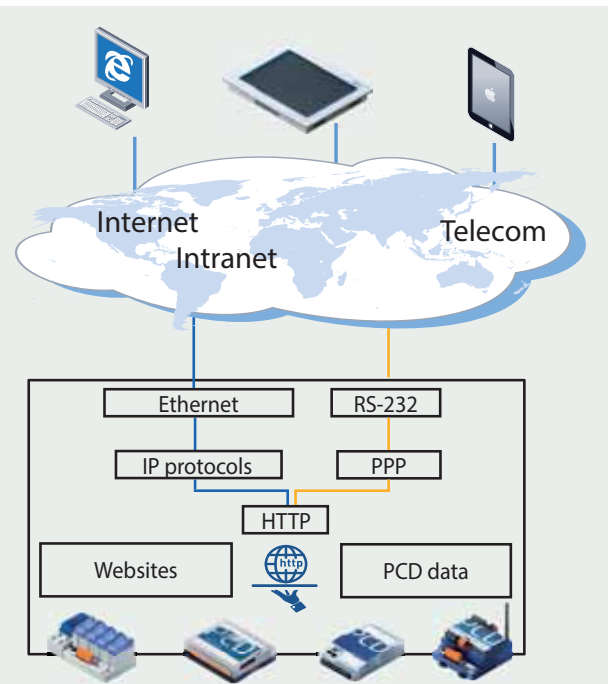

Hypertext Transfer Protocol (HTTP) is a protocol used for transferring data across a network. With Saia PCD<sup>®</sup>s, the protocol is used for accessing the PCD-Web-Server.

### PG5 device configurator settings

- ▶ Activating/deactivating the HTTP port
- ▶ Advanced settings (buffer, sessions, keep alive timeout, etc.)

<b>HTTP Direct / First Listener</b>	
HTTP TCP/IP Port Enabled	Yes
TCP Port Number	80
+ Advanced Parameters	Hide
<b>HTTP Direct / Second Listener</b>	
HTTP TCP/IP Port Enabled	Yes
TCP Port Number	81
+ Advanced Parameters	Hide

### Technical data

HTTP standard	1.0 and 1.1 (RFC 2616)
2 adjustable listener ports	Standard 80 and 81
Number of sessions	8 parallel with keep alive (default setting, max. 32 adjustable)
Interfaces	Ethernet, serial RS-232 with PPP, the HTTP protocol can also be encapsulated in the S-Bus and therefore used via other interfaces such as USB. For details please refer to chapter B3 S-Web technology

## FTP: Protocol for transferring files

The File Transfer Protocol (FTP) is used to load files into or read files from PCD devices via the network. Files (websites, log data, documents, etc.) are stored in the PCD device's file system. User groups and passwords can be set up to protect access to the FTP server and individual files (e.g. read only).

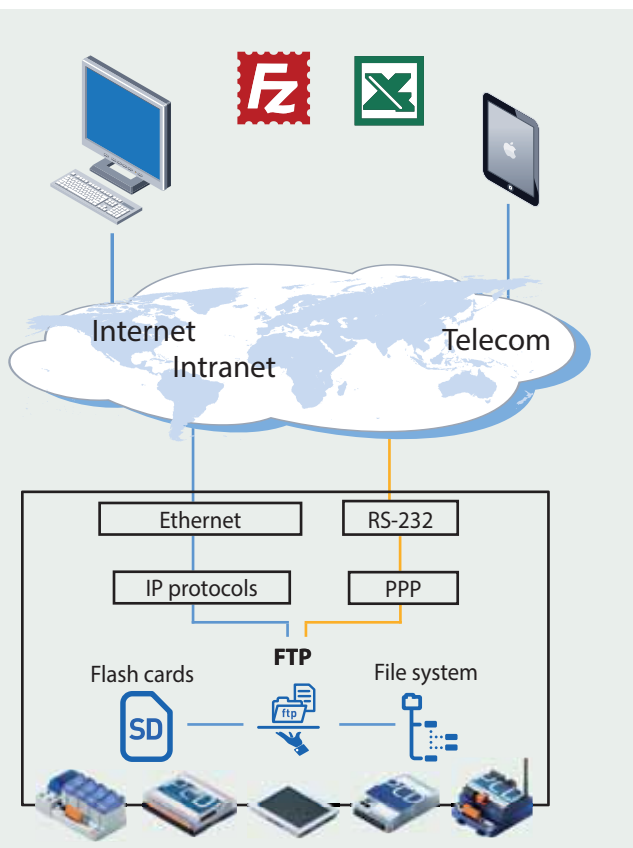

### PG5 device configurator settings

- ▶ Activating/deactivating the FTP server
- ▶ Configuring port numbers (standard port: 21), user and access rights
- ▶ Advanced settings (no. of connections, timeout, etc.)

FTP Server	
FTP Server Enabled	Yes
TCP Port Number	21
User Name 1	
User Name 2	
+ Advanced Parameters	Hide

### Technical data

FTP standard	RFC 959
Standard port number	21 (can be adjusted) plus dynamic port (> 1023) for data
Connection mode	PCD devices only support the active FTP mode
Number of FTP connections per PCD	Standard 3 (max. 5 adjustable)
Interfaces	Ethernet, serial RS-232 with PPP



### Active/passive FTP mode

PCD devices only support the active connection mode!

The client establishes a connection to server port 21 and provides the server with the port number for the data channel. In contrast to passive mode (where the data channel port is always 20), this port number is not preset and can be > 1023. This often causes problems with firewalls since these port numbers are not approved.

Another means of transferring files is to use FTP-CGI (Common Gateway Interface) interfaces in the web server. Knowing the respective syntax, it is also possible to transfer data between a web client and PCD devices via this interface. For more information on this please refer to Chapter B2 S-Web.

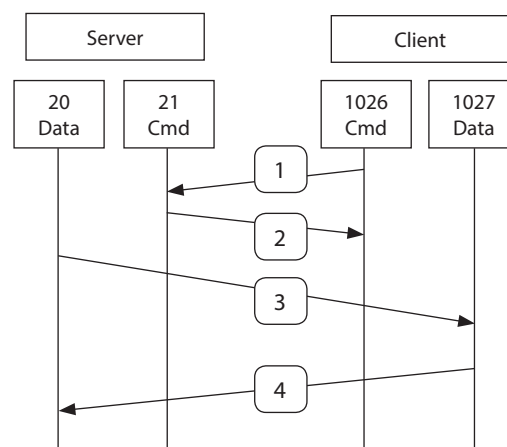

## SNMP Simple Network Management Protocol

The Simple Network Management Protocol was developed to be able to monitor and control network elements such as routers, servers, switches or even Saia PCD® (agents) from a central station. The SNMP manager software usually runs on a server. It monitors and controls the SNMP agents. The SNMP manager reads and sends data from agents using SET and GET commands. The SNMP agent can also send so-called trap messages to the SNMP manager unrequested. This allows faults to be reported immediately, for example.

The Saia PCD® MIB has been specified for Saia PCD® with SNMP support. It includes all resources which can be requested and changed using SNMP. It is possible to access all PCD media (inputs/outputs, register, flag, DBs, etc.). In the MIB file, the programmer is able to restrict access to selected areas only. The MIB II standards for managing the TCP/IP functions defined according to RFC1213 are also supported.

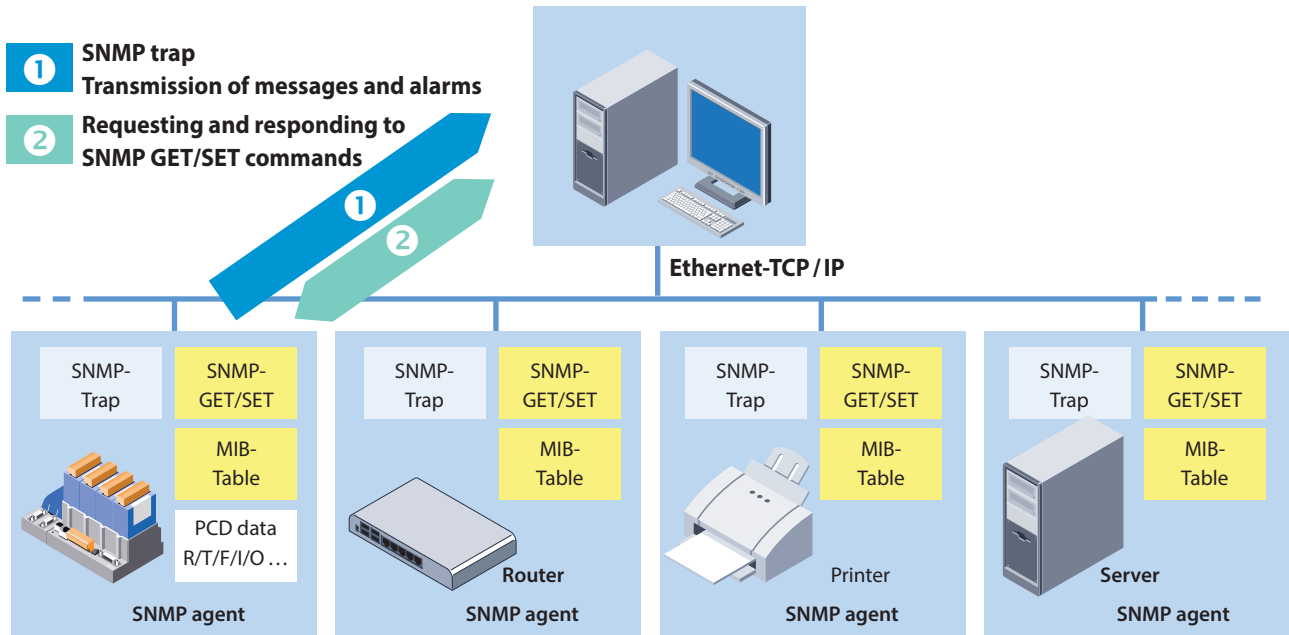

### Configuration

Simple activation and configuration of the SNMP functionality in the PG5 device configurator. Up to 3 SNMP trap receivers can be configured. The data fields to which the SNMP manager has access are also configured here.

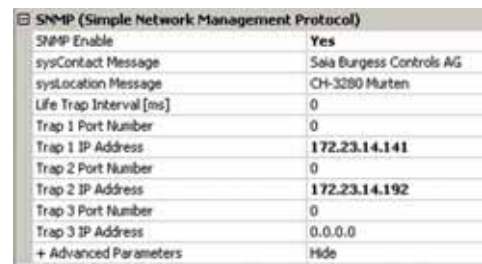

### FBoxes

Trap messages with integer or Boolean data or text information can be conveniently sent to the trap receivers using FBoxes.

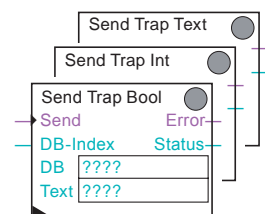

### SBC MIB File Generator

The MIB file contains pre-defined SNMP strings for accessing the PCD data (register, flag, DB, etc.) with the SNMP manager. The MIB files can be generated with project-specific symbol names using the MIB file generator (available with PG5 V2.1).

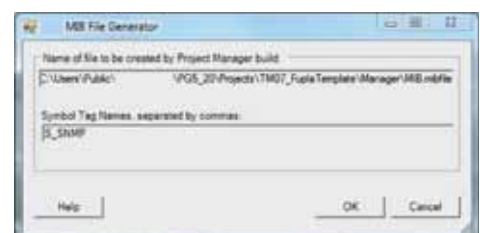

### Technical data

SNMP Standard	V1 and V2c (RFC 1157)
	Supports MIB-II Standard in accordance with RFC 1213
Standard Ports	#161 and #162



### SMTP: Protocol for sending emails

The email function and integrated SMTP client (Simple Mail Transfer Protocol) can be used to send PCD device process and system information to an email server. This enables alarm, service and status messages, log data or any form of process information to be sent via email to a control centre or service personnel.

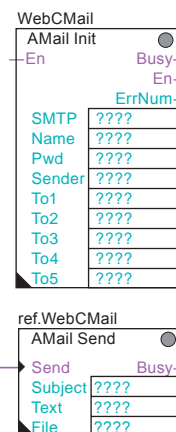
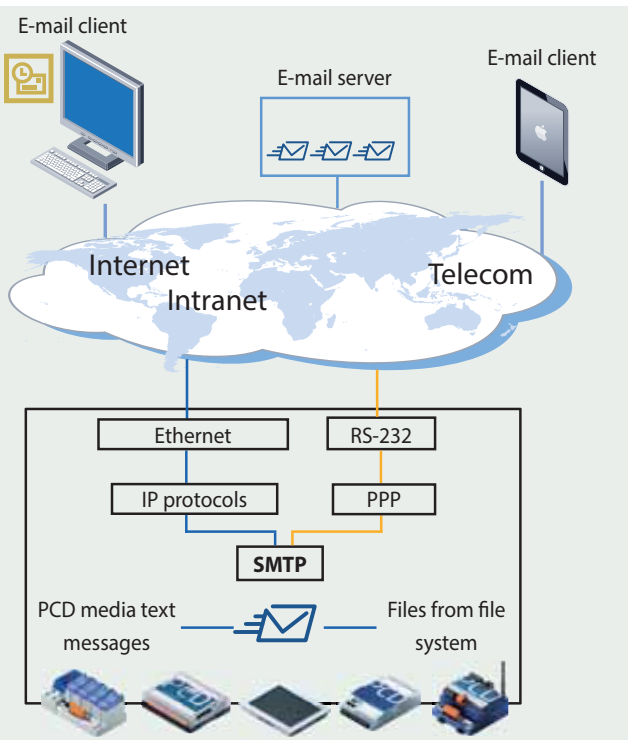

#### FBoxes

FBoxes are available for sending emails using the application program. The email function is configured (mail server, port number, user and password, etc.) via these FBoxes. It is also possible to send file attachments (e.g. log data) of up to 1 MByte.

#### Technical data



SMTP Standard	RFC 821, 822
Standard port number	25 (adjustable) + 587
Server authentication	«AUTH LOGIN» or «AUTH PLAIN» in accordance with RFC 2595 (unencrypted transmission of password)
Email format	Text or HTML
Interfaces	Ethernet, serial RS-232 with PPP

### PPP: Point to Point Protocol

This is a protocol established along a communication route from one point (location) to another. PPP is a protocol that is mainly used to transport TCP/IP protocols via a serial cable or modem connection. In order to meet the greater security needs demanded when dialling into company networks or systems with critical tasks, CHAP (Challenge Authentication Protocol) was introduced.

The user has access to the web and FTP server via a Telekom interface (PSTN, ISDN, GSM/GPRS) in the Saia PCD® controller. This also applies to applications with more economical devices and no Ethernet connection.

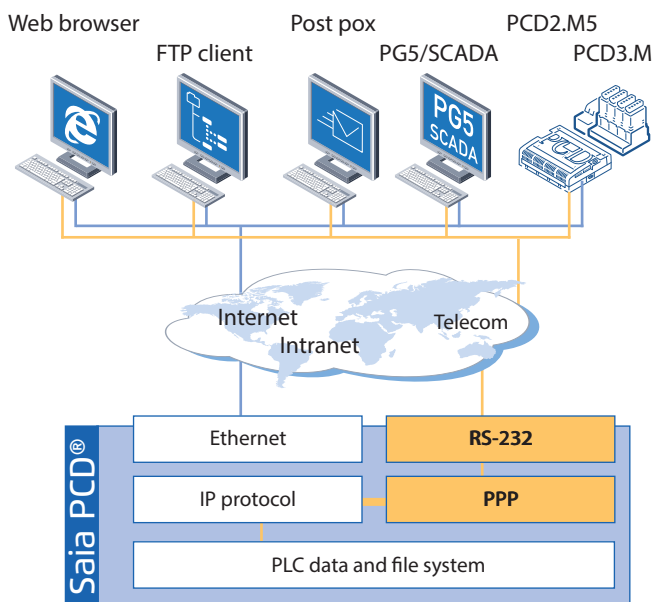

Standard	RFC-1661
Authentication	PAP, CHAP and MS-CHAP
Simultaneous PPP connections	Only one PPP connection (client or server) can be active per Saia PCD® controller.
PPP via Ethernet	No

## 2.4 Wide Area Automation with Saia PCD®

Spanning geographical distances with a larger number of substations often places significant demands on a system. The integrated automation server can be used to combine geographically distributed systems easily using the Internet and Intranet. This allows the systems to be monitored and controlled remotely. It is possible to access the controllers directly during commissioning or servicing.

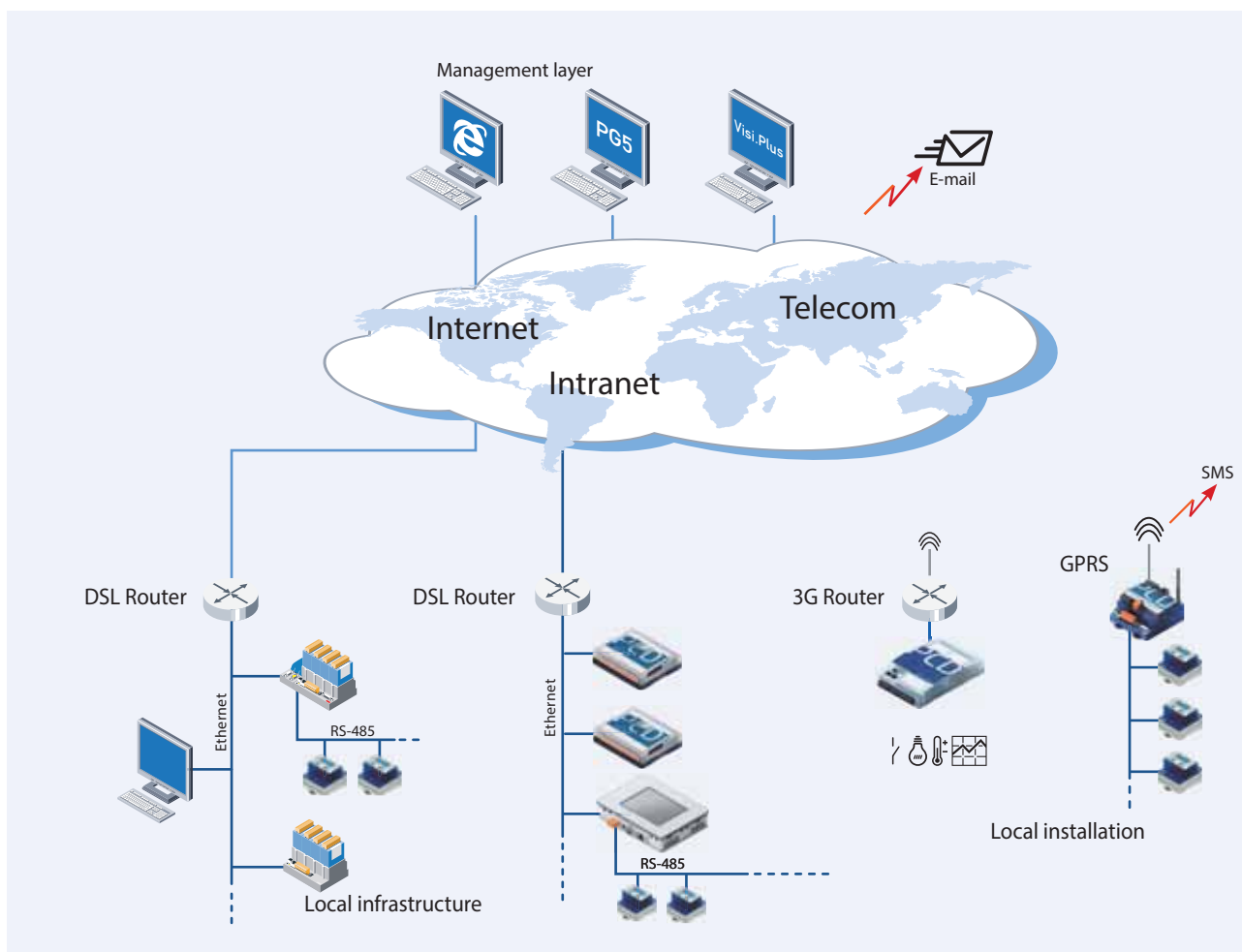

### Networks for Wide Area Automated Systems

PCD controllers support the connection to the WAN (Wide Area Network) via all established telecommunication technologies. The IP-based protocols (automation server) are used to connect directly to the Internet either wired via Ethernet interfaces and DSL broadband routers or wirelessly with GPRS/UMTS routers. Non-IP based connections with analog, digital (ISDN) or GSM modems are also supported. The PCD3.WAC (Wide Area Controller) allows a direct connection via the integrated analog, ISDN or GPRS/GSM modems.

### Protocols and services

The WEB/IT protocols are used to support access to the automation server functions (web/FTP server, email, SNMP, etc.).

The S-Bus protocol enables communication with the PG5 programming device, the SBC OPC server or Visi.Plus. S-Bus is also used to exchange data between PCD controllers via the WAN.

Other IP-based protocols such as Modbus TCP and BACnet® are also supported.

### Products for Wide Area Automation

Broadband routers for DSL or 3G (UMTS) Telekom networks: standard commercial products of third party providers can be used

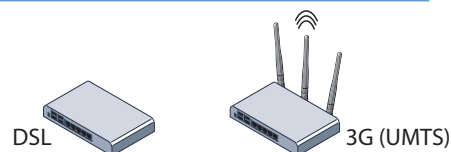

PCD3.M2330 Wide area controller with optional integrated PSTN, ISDN or GSM/GPRS modem (for further details see chapter A1.2.3 "Wide Area Controller")



PSTN (Q.M716-KS1), ISDN (Q.M726-RS1) and GSM cap rail modem (Q.M736-AS2) (for further details see chapter A1.7 "Automation technology accessories")



## Functions for Wide Area Automation

### FBoxes for sending emails

FBoxes are available for sending emails using the application program. It is possible to send alarm, status and text messages. Sending file attachments (e.g. log data) is also supported.

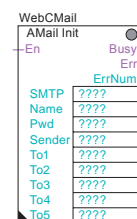

### Connection and availability with PCD3.WAC or external GPRS modem

Local networks are often connected to the Internet via a router. The router settings can be used to specify the availability and security options. Controllers with an integrated GSM/GPRS modem have the problem that the GPRS network operator often no longer issues fixed public IP addresses. One option for preventing the dynamic issuing of the IP address is the DynDNS service. This service now makes it possible to reach controllers using a fixed name. The service is controlled directly via FBoxes in the application program.

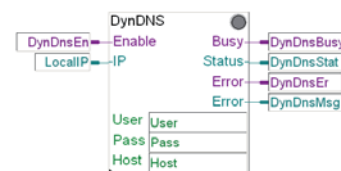

### Diagnostic tools

The controller uses so-called "lifechecks" to check at periodic intervals whether the Internet still exists. If the connection has been interrupted, e.g. in the case of GPRS network disturbances, the controller is able to re-establish the connection to the Internet.

Other diagnostics parameters independently monitor the communication e.g. to avoid roaming costs.

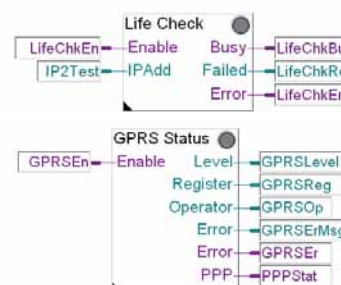

### FBoxes for modem communication

Communication via GSM, PSTN or ISDN modems is supported via a comprehensive FBox library. SMS messages can be sent and received.

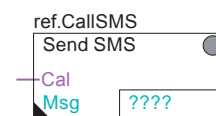

## Security

When setting up Wide Area Networks via the public Internet, the topic of security must also be given consideration. Installations and systems should be protected against unauthorised access with a password. Sensitive data must sometimes also be encrypted before transmission. Effective access protection should also be considered within a closed company network.

Saia PCD® controllers include a basic security function. For example, communication interfaces and individual functions can be deactivated. Access to the automation server (web server, FTP server, etc.) can be protected with a simple password login.

It is the responsibility of the programmer to make use of these protective functions. They are simple basic functions. Highly secure protective functions are implemented using external, specially designed communication components and devices such as routers and firewalls. Today's commercially available routers have suitable protective mechanisms in addition to the normal communication functions, e.g. access protection with user administration, firewalls, encryption and protected VPN (Virtual Private Network) connections.



When connecting PCD controllers to the Internet, it is recommended using routers with suitable protective functions and configuring them according to the security requirements.

## 2.5 S-Net for communicating between Saia PCD® devices

### 2.5.1 The basic features of S-Net

S-Net incorporates the S-Bus and S-I/O system protocols for communicating between SBC devices. Both protocols are optimised for SBC devices and compared to other standard protocols (e.g. Modbus) they offer greater functionality and are simpler and more efficient to use.

**S-Bus** supports all services and functions regarding the exchange of data, programming, commissioning and service of Saia PCD® controllers. The S-Bus protocol does not depend on the physical aspects and can be used on Ethernet, USB, Profibus-FDL and serial interfaces (RS-232, RS-422, RS-485).

The **S-I/O** protocol supports the operation of SBC remote I/O stations with Ethernet (PCD3.T66x) and Profibus (PCD3.T760)

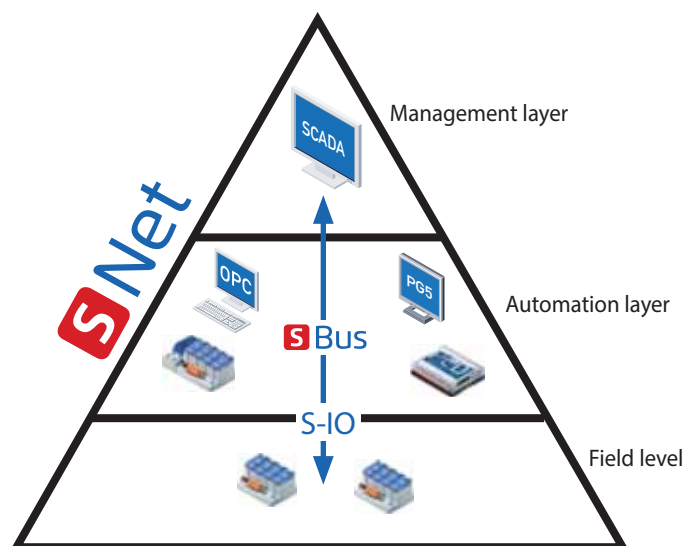

S-Net communicating between SBC devices across all layers

#### Services and functions using S-Bus

##### Programming and commissioning

S-Bus is the programming device system protocol. It supports all programming, commissioning and diagnostic functions.

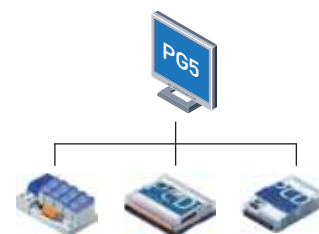

The programming device is accessed via Ethernet, USB or serial interfaces.

##### Exchanging data between PCD controllers

S-Bus supports the transmission of all PCD media (register, flags, timer/counter, database and text) and is optimized for the exchange of data between PCD controllers whereby Ethernet and Profibus allow multi-master operation.

Serial interfaces (RS-232, RS-422, RS-485) enable "single"-Master-Slave mode or S-Bus-Master-multiple-Slave mode.

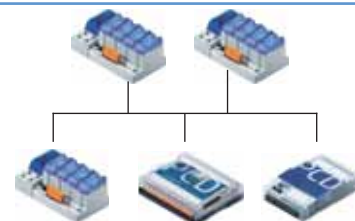

Exchanging data between PCD controllers via Ethernet, Profibus or serial interfaces

##### Visualising with OPC servers and SCADA systems

S-Bus together with an OPC Server or the SBC.Net-Suite supports access (reading and writing) to all PCD data with a Windows SCADA system.

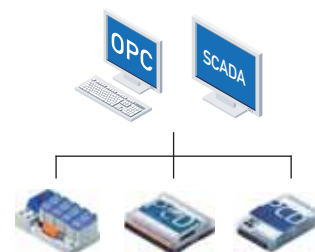

Connecting to SCADA systems via Ethernet, USB, Profibus or serial interfaces

##### Visualising with web browsers

S-Bus supports HTTP protocol transmission. This also allows websites to be transmitted together with "SBC-Web.Connect" via USB and serial interfaces and displayed on a Windows PC with the standard web browser or a micro-browser web panel.

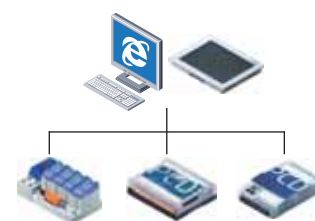

Access to the PCD web server is also possible via USB and Serial interfaces

## 2.5.2 Ether-S-Net: S-Bus and S-IO protocol with Ethernet

The Ether-S-Bus and Ether-S-IO protocols support the operation of Saia PCD® controllers and Smart-RIOs on Ethernet. The PCD devices can be integrated and operated in a standard Ethernet network (together with other devices). Multi-protocol operation is supported on the same connector and cable. That means that all IP protocols (e.g. access to the automation server) can be used in parallel with S-Bus and/or S-IO.

### Ether-S-Bus for operating PCD controllers with Ethernet

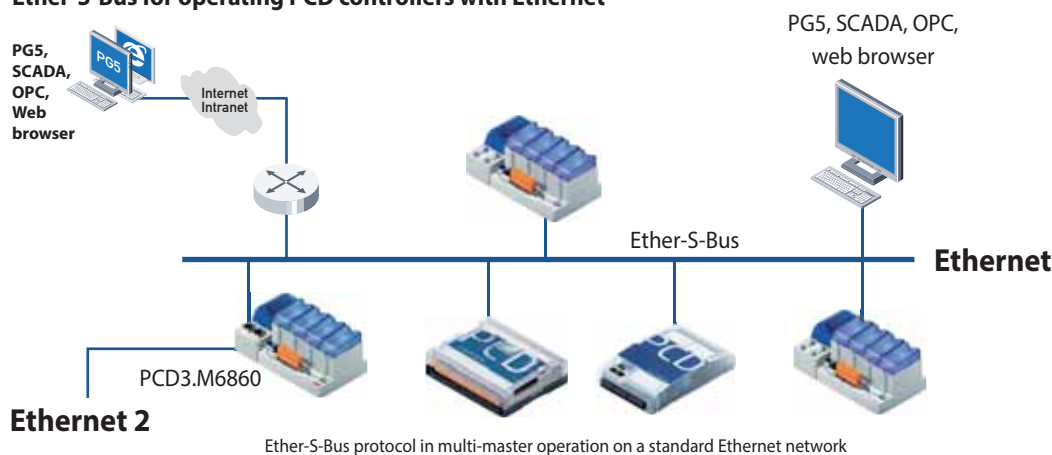

Ether-S-Bus protocol in multi-master operation on a standard Ethernet network

### Properties, functions

- ▶ Ether-S-Bus supports communication between
  - PCD controllers in multi-master operation
  - a PCD controller and the PG5 programming device
  - a PCD controller and the OPC server or SCADA system with Ether-S-Bus driver
  - a PCD controller (PCD-Web-Server) and web browser with Web-Connect software
- ▶ Programming the data transfer between PCD controllers with FBoxes for cyclic or event-controlled data transfer
- ▶ Multi-protocol operation on the same Ethernet connection (e.g. Ether-S-Bus, Ether-S-IO and other protocols such as Modbus-TCP)
- ▶ Gateway function for gateways (Ether-S-Net ↔ Serial-S-Net, Ether-S-Net 1 ↔ Ether-S-Net 2, Ether-S-Net ↔ Profi-S-Net)
- ▶ The PCD3.M6860 CPU can be used to construct separate networks or redundant Ethernet networks
- ▶ The network can be constructed using standard Ethernet components
- ▶ IP protocol: UDP
- ▶ Port number: 5050 (a firewall may require this port to be activated)

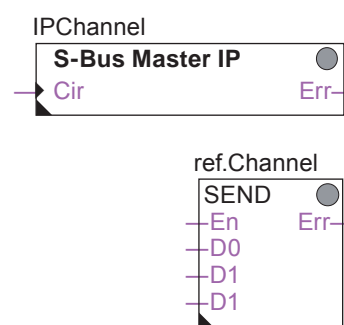

### Ether-S-IO for operating Smart-RIOs PCD3.T66x

#### Properties, functions

- ▶ Ether-S-IO supports the exchange of data between Smart-RIO Manager and the Smart-RIOs. Ether-S-Bus is used to transfer the configuration and any programs
- ▶ It uses broadcast or unicast telegrams (adjustable)
- ▶ The data transfer is configured by the RIO network configurator
- ▶ Multi-protocol operation is supported
- ▶ The network can be constructed using standard Ethernet components
- ▶ IP protocol: UDP
- ▶ Port number: 6060

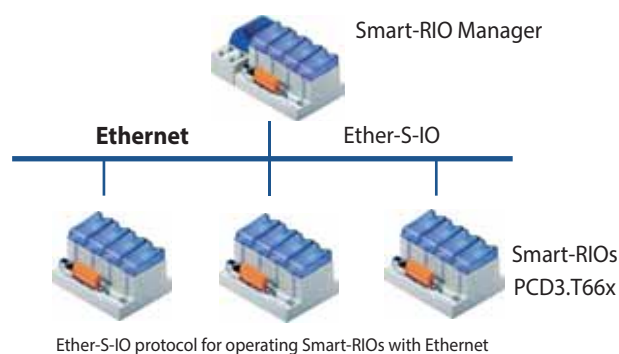

Ether-S-IO protocol for operating Smart-RIOs with Ethernet

## Constructing Ethernet networks separately or redundantly with PCD3.M6860\*

The PCD3.M6860 CPU has two independent Ethernet interfaces which are used to construct physically separate networks (e.g. company or automated system networks) or redundant networks. The second interface is fitted with an additional 2-port switch.

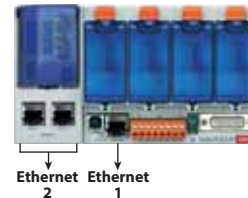

### Properties, functions

- ▶ The technical data of the PCD3.M6860 are identical to those of a PCD3.M5560, apart from the second Ethernet interface (in place of the serial interfaces)
- ▶ The Ethernet interfaces are separate and both have an independent IP configuration. The IP addresses must not be in the same subnet. IP routing between the two interfaces is not supported.
- ▶ All IP protocols are supported on both interfaces. This enables access to the automation server and the PCD data via both interfaces. Access to the PG programming tool is also supported on both interfaces.
- ▶ BACnet and LoN IP are only supported on one interface (1 or 2)
- ▶ The S-Bus gateway function between the two Ethernet interfaces is also supported

### Separating Ethernet networks

It is worth physically separating networks when:

- ▶ The automation devices and the standard IT devices (PC, server, etc.) must not be operated on the same network for security reasons. In this instance, the PCD3.M6860 functions like a "firewall" as only S-Bus telegrams can be transmitted from one interface to another. Other IP telegrams are not routed.
- ▶ The data traffic cannot take place in the same physical network for performance reasons
- ▶ The infrastructure (e.g. network cabling) requires separation

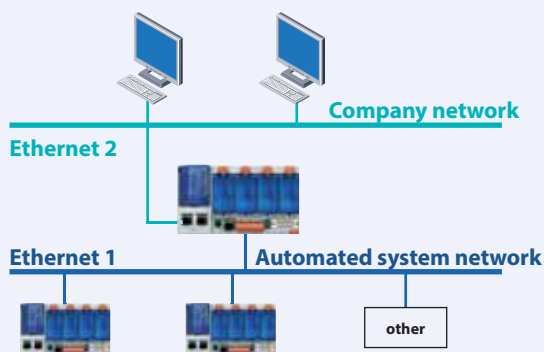

The automated system and company networks are physically separate

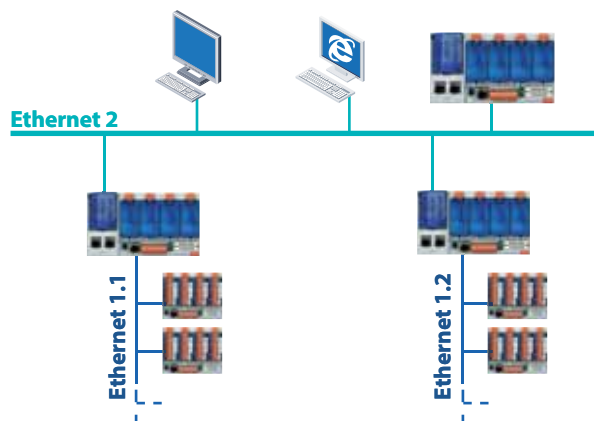

The automated system network can be divided into several physical networks for better organisation and increased availability and performance.

### Constructing redundant Ethernet networks

Network redundancy is often required by systems with high demands placed on them with regard to operational availability, such as tunnel controllers in traffic technology, or on ships, for example. The two Ethernet connections provide the PCD3.M6860 with connection redundancy. Standard components (switches and cables) can be used to construct two separate, redundant networks. The networks and choice of interfaces are monitored by the application program. Together with specific switches and fibre-optic cables, the network availability can be raised further by creating a fibre optic ring. The switches automatically identify an interruption to the ring and reroute the data traffic accordingly.

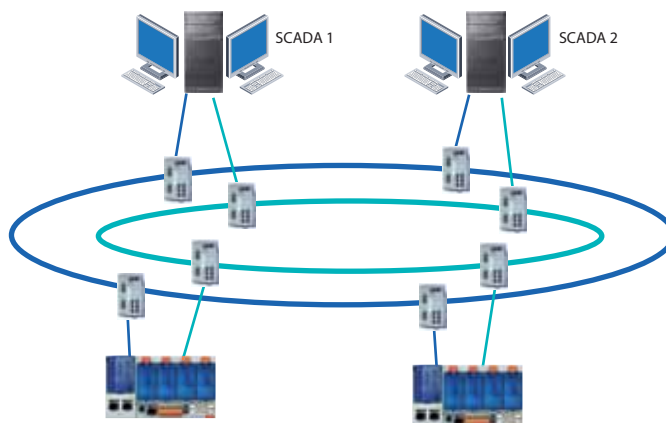

Highly available Ethernet with two fibre optic rings. In the event of an interruption, the switches automatically reroute the data traffic via the ring which is still functioning. A defective switch or ring can be recognised in the application program and the data traffic transmitted via the second ring or second interface.



## 2.5.3 Serial-S-Net: S-Bus on USB and serial interfaces, RS-232, RS-422/485

The S-Bus protocol can be used on the USB and serial interfaces for communicating with Saia PCD® controllers. This makes it possible to construct very simple, economical communication links and networks. Point-to-point (USB, RS-232) and 1:n communication relationships are supported in the RS-485 network in master-slave operation.

S-Bus supports communication between

- ▶ PCD controllers in master-slave (1:n) operation
- ▶ a PCD controller and the PG5 programming device
- ▶ a PCD controller and OPC server or SCADA system with S-Bus driver
- ▶ a PCD controller (PCD-Web-Server) and web browser with Web-Connect software

### Point-to-point communication relationship with S-Bus

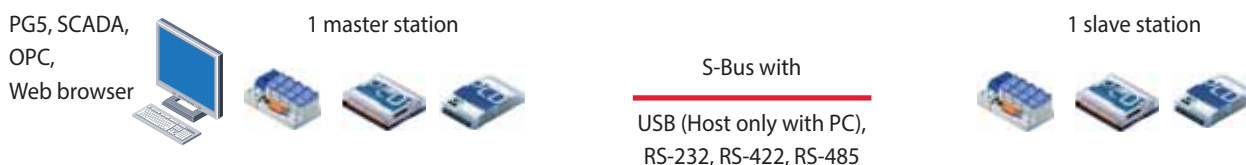

### Properties, functions

- ▶ Interfaces: USB, RS-232, RS-422, RS-485 (can be used simultaneously on several interfaces)
- ▶ Baud rate: up to 12 MBit/s (USB standard 1.1)
- ▶ Communication relationship: master-slave
- ▶ Exchange of data with a SCADA system together with the SBC OPC server or an S-Bus driver
- ▶ Supports communication via modem (PSTN, ISDN, GSM) to RS-232 interface

### 1:n master slave communication relationships in RS-485 network with S-Bus

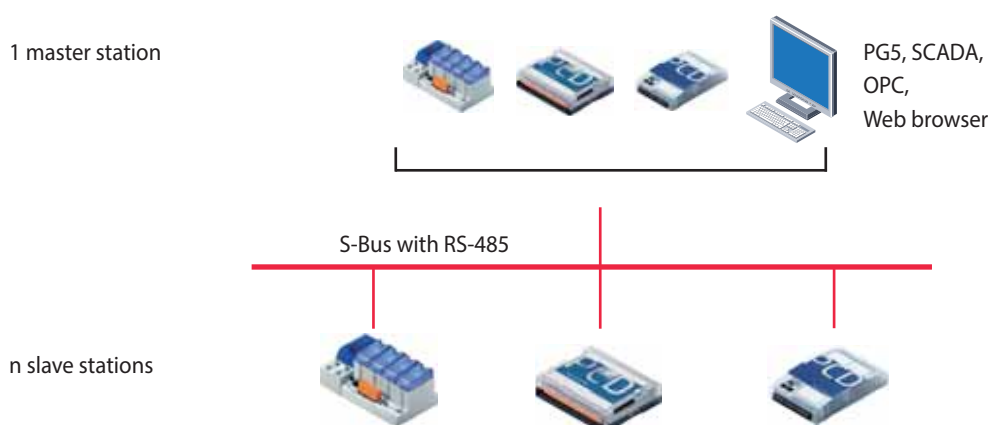

### Properties, functions

- ▶ Interfaces: RS-485 (can be used simultaneously on several interfaces)
- ▶ Baud rate: up to 115 kBit/s
- ▶ Bus cable: 2-wire, twisted and shielded (min.  $2 \times 0.5 \text{ mm}^2$ )
- ▶ Bus length: max. 1200 m per section
- ▶ Number of stations: max. 32 per section, total max. 255
- ▶ Number of sections: max. 8, connected to one another via RS-485 repeater
- ▶ Communication relationship: master-slave (only 1 master)
- ▶ Programming the data transfer between PCD controllers with FBoxes for cyclic or event-controlled data transfer
- ▶ Exchange of data with a SCADA system together with the SBC OPC server or an S-Bus driver

### Note

The S-Bus protocol is also suitable for constructing multi-point wireless networks with external wireless modems. The wireless modems are connected to the RS-232 interface. The control cables can be used to control the wireless modem transmitters. Further information on this can be found in reference manual 26-739.

The proprietary SBC S-Bus is designed for communicating with the Saia PG5® engineering tool, connecting to the management layer/process control systems and for communicating with the PCD. It is not suitable or approved for connecting field devices of other manufacturers. An open, manufacturer-independent field bus (e.g. Profibus, Modbus, etc.) is the appropriate tool in this case.

## 2.5.4 Profi-S-Net: S-Bus and S-IO protocols on Profibus-FDL

The Profi-S-Bus and Profi-S-IO protocols support the operation of Saia PCD® controllers and Saia PCD3.T760 RIOs on the Profibus-FDL network. The protocols can be operated up to 1.5 MBit/s via the RS-485 interfaces integrated in the base unit. This makes it possible to realise economic and fast communication networks in multi-master operation. Multi-protocol operation is supported on the same connector and cable. Selecting the same bus parameters (baud rate, timing, etc.) enables the PCD devices to be operated together with devices of other manufacturers on one Profibus DP network.

### Profi-S-Bus for operating PCD controllers on Profibus-FDL networks

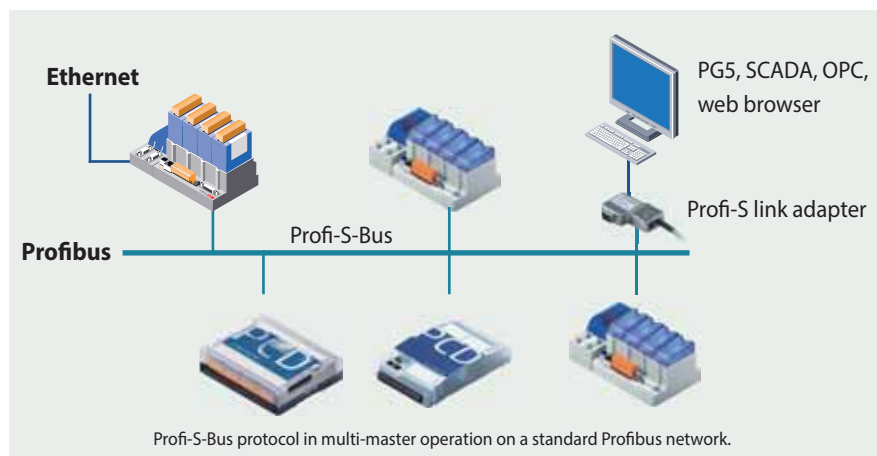

#### Properties, functions

- ▶ Profi-S-Bus supports the communication between
  - ▶ PCD controllers in multi-master operation
  - ▶ a PCD controller and the PG5 programming device (via Profi-S-Link)
  - ▶ a PCD controller and OPC server or SCADA system with Profi-S-Bus driver (via Profi-S-Link)
  - ▶ a PCD controller (PCD-Web-Server) and web browser with Web-Connect software (via Profi-S-Link)
- ▶ Multi-protocol operation on the same Profibus network (e. g. Profi-S-Bus together with other Profibus DP devices)
- ▶ Gateway function (Profi-S-Bus ↔ Serial-S-Bus, Profi-S-Bus ↔ Ether-S-Bus)
- ▶ Programming the exchange of data between PCD controllers with FBoxes for cyclic or event-controlled data transfer – Baud rate: up to 1.5 MBit/s
- ▶ Network infrastructure and topology: in accordance with Profibus specification
- ▶ Profi-S-Link adapter: PCD8.K120

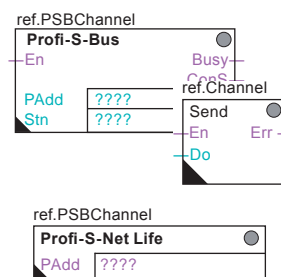

### Profi-S-IO for operating PCD3.T760 RIOs on the Profibus

#### Properties, functions

- ▶ Profi-S-IO supports the data transfer between a PCD.RIO master and PCD3.T760 RIOs.
- ▶ The data transfer is configured by the Profi-S-IO network configurator
- ▶ Multi-protocol operation is supported (e. g. Profi-S-Bus and Profi-S-IO)
- ▶ Baud rate: up to 1.5 MBit/s
- ▶ Network infrastructure and topology in accordance with Profibus specification

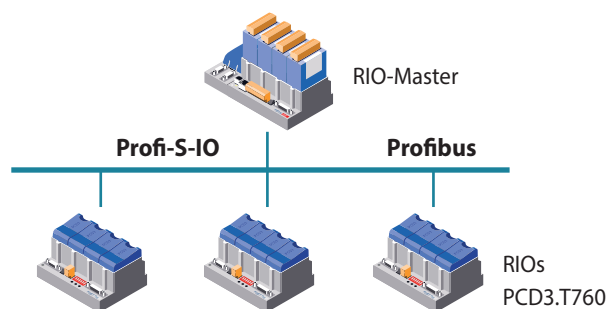

Profi-S-IO protocol for operating PCD3.T760 RIOs on the Profibus

## 2.5.5 Profibus DP Integrating machines and industrial environments

# PROFIBUS

### Profibus in building automation systems

According to EN 50170, Profibus is the internationally standardised bus for industry and building automation systems. Profibus opens up the world of standardised network communication for a wide range of applications between different manufactures:

- ▶ Profibus is open and not tied to any specific manufacturer

- ▶ PNO, the Profibus user organisation, maintains a qualified certification system and assesses Profibus products with regard to compliance with standards and interoperability
- ▶ Profibus DP, the up to 12 MBit/s network protocol for the field layer in automated production is also used in building automation systems thanks to the large range of accessories

### Profibus-DP with Saia PCD®

Saia PCD® controllers are available with Profibus DP master and slave connections. Version DP V0 is supported. Decentral data points under the designation PCD3.T760 supplement the Profibus product range and enable the construction of decentralised automation solutions.

Thanks to the diverse communication properties, Saia PCD® controllers are ideal for use as communication gateways, e.g. Ethernet–Profibus, BACnet–Profibus, etc.

### Saia PCD® systems with Profibus DP master 12 MBit/s connection

Baud rate	Connection	Port	Galvanic separation	System
Up to 12 MBit/s	D-Sub connector	# 10	Yes	PCD3.M6560
Up to 12 MBit/s	D-Sub connector	# 10	Yes	PCD2.M5540 with PCD7.F7500 module

### Saia PCD® systems with Profibus DP slave, on-board interface

Baud rate	Connection	Port	Galvanic separation	System
Up to 187.5 kBit/s	Terminal block	# 2	No	PCD3.M6560, PCD3.M6860, PCD3.M5340, PCD3.M3xxx, PCD3.M2130V6, PCD3.M2330A4Tx, PCD3.M2230A4T5, PCD1.M2xxx, PCD1.M0160E0
Up to 1.5 MBit/s	D-Sub connector	# 10	Yes	PCD3.M5560, PCD3.M5540, PCD3.M5440, PCD2.M5540, PCD3.T760 (RIO)

### Network configurators for Profibus

The PG5 programming tool contains convenient network configuration tools for all types of network. The user uses these to define his variables, objects and network parameters.

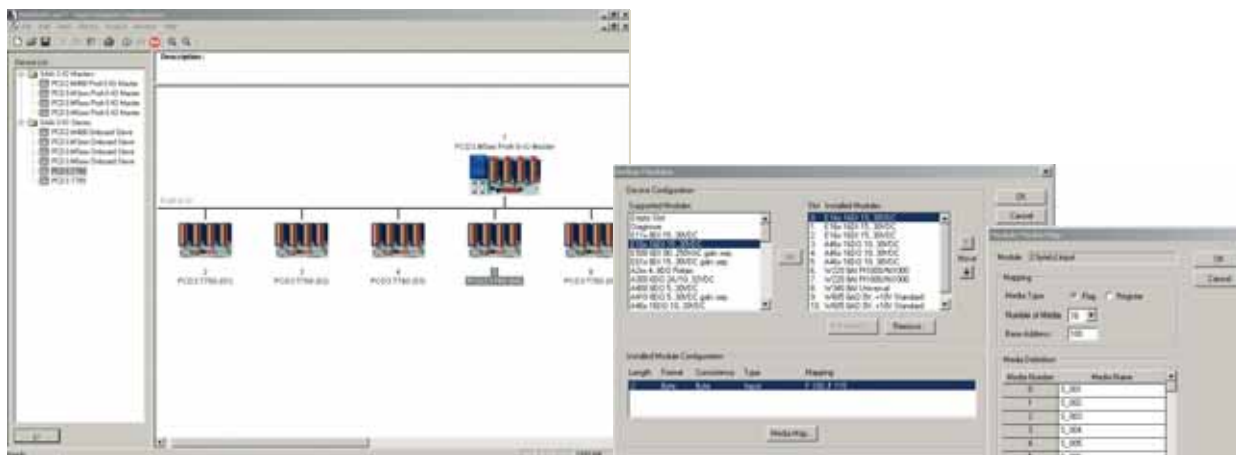

## 2.6 BA communications systems

### 2.6.1 BACnet®

#### The standard for building services

BACnet is a manufacturer-independent, globally standardised communication protocol which is well-established in building automation systems. BACnet is particularly suitable for heterogeneous structures involving automation stations of various manufacturers. The server/client architecture allows each of the BACnet devices to exchange data with one another without having to adjust to the parameterisation of the other devices. BACnet is far more than a protocol for merely transferring data; BACnet itself defines important building automation functions, such as the recording of historic trends or the monitoring of values against set limit values, for example. It provides communication services (BIBBs: BACnet Interoperable Building Blocks), such as those for reading and writing content, event-controlled transmission following changes and the handling of alarms/information (events).

#### PCD systems

BACnet is available for all classic PCD systems with the Saia PCD® COSinus operating system as a communication option. The connection is usually direct via BACnet-IP (Ethernet). BACnet MS/TP (RS-485) is also possible via a communication module. BACnet always requires a BACnet option module for firmware expansion. A PCD7.R56x is used for memory slots M1 and M2 for PCD3.M5-, PCD2.M5-, PCD1.M2- and PCD1.M0-controllers. The PCD3.R56x module is available for I/O slots 0...3 for PCD3.M3 controllers without M1/2 slots.

PCD2.M5 and PCD1.M2 controllers also require a PCD2.F2150 for connecting BACnet MS/TP, and PCD3 controllers require a PCD3.F215 interface. This module also provides controllers without Ethernet with a BACnet interface. Controllers with Ethernet also take on the function of a BACnet-IP-MS/TP router. External gateways for connecting MS/TP devices directly to the management system or other BACnet-IP devices, for example, are therefore no longer required.

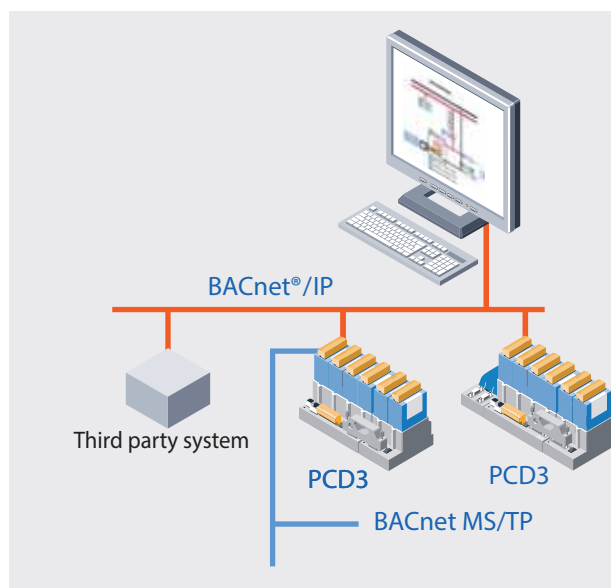

#### Typical applications of a BACnet infrastructure

- ▶ Heating, ventilation and climate control
- ▶ Room automation
- ▶ Networking dispersed sites
- ▶ Recording energy data



BACnet certificates for PCD1, PCD2, PCD3 controllers; see [www.sbc-support.com](http://www.sbc-support.com), Certificates, PCD

#### Recommendations/system limits

Model	Option	Interface	PG5 configuration, system limits
PCD3.M5560	1× PCD7.R56x 4× PCD3.F215*	IP MS/TP	Recommended for configurations of up to 1000 BACnet objects Suitable for BACnet® and LonWorks® in parallel operation
PCD3.M5540 PCD3.M5340	1× PCD7.R56x 4× PCD3.F215*	IP MS/TP	Recommended for configurations of up to 800 BACnet objects
PCD3.M3330 PCD3.M3120	1× PCD3.R56x 3× PCD3.F215*	IP MS/TP	Recommended for configurations of up to 500 BACnet objects
PCD2.M5540	1× PCD7.R56x 4× PCD2.F2150*	IP MS/TP	Recommended for configurations of up to 800 BACnet objects
PCD1.M0160	1× PCD7.R56x	IP	Recommended for configurations of up to 800 BACnet objects
PCD1.M2xx0	1× PCD7.R56x 2× PCD2.F2150*	IP MS/TP	Recommended for configurations of up to 800 BACnet objects
PCD1.M2020 Without Ethernet	1× PCD7.R56x 2× PCD2.F2150*	MS/TP	Recommended for configurations of up to 250 BACnet objects

# BACnet®

## Efficient engineering through automatic generation

The application FBox libraries from DDC Suite v2.0 and Room Controller v2.0 onwards give the system integrator even more convenience. An FBox parameter can be used to automatically generate a suitable BACnet® configuration when creating the application program. All necessary settings take place within the application FBoxes.

## Freely programmable BACnet configuration

The application can be created as usual using the Saia PG5® Controls Suite. The BACnet® configurator it contains allows the completely free parameterisation of all BACnet® objects. This makes it possible to solve all conceivable tasks. Clearly structured dialogs make the parameterisation of schedules, trends and alarms easy to understand.

### PG5 FUPLA Editor

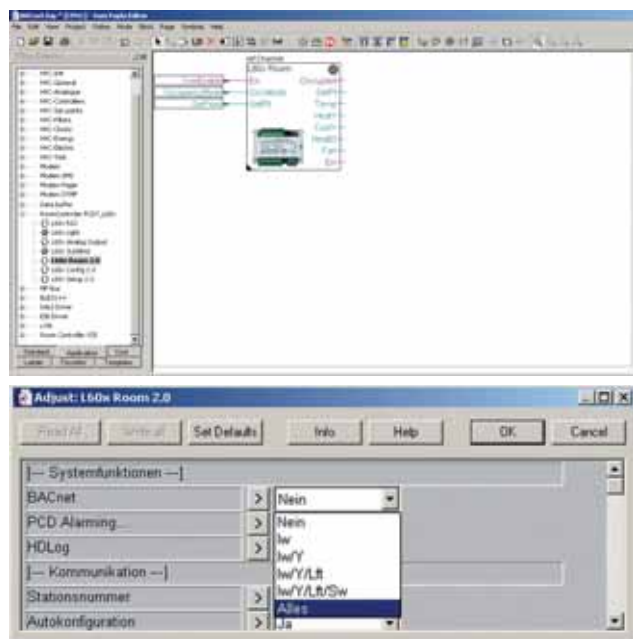

BACnet® Adjust Window

### BACnet® configurator in the Saia PG5® Controls Suite

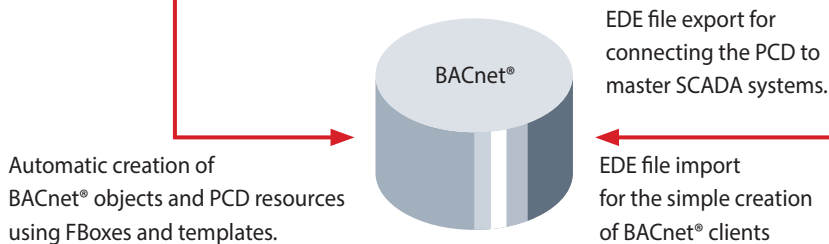
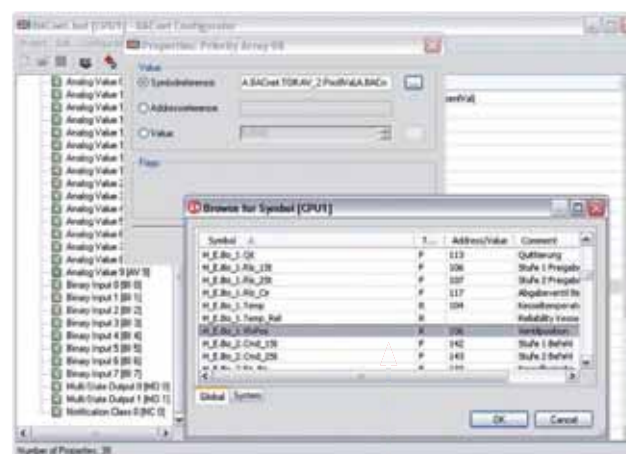

### Order information

Model	Description
PCD7.R560	BACnet® options module for PCD1.M0, PCD1.M2, PCD2.M5, PCD3.M5 and PCD3.M6 for slot M1 or M2
PCD7.R562	BACnet® options module for PCD1.M0, PCD1.M2, PCD2.M5, PCD3.M5 and PCD3.M6 for slot M1 or M2 incl. 128 MB for program backup and file system
PCD3.R560	BACnet® options module for PCD3.M3, PCD3.M5 and PCD3.M6 for I/O slot 0...3
PCD3.R562	BACnet® options module for PCD3.M3, PCD3.M5 and PCD3.M6 for I/O slot 0...3 incl. 128 MB for program backup and file system

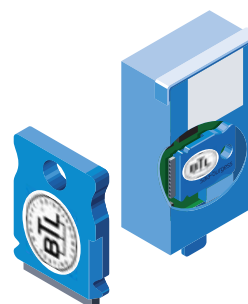

1 SBC Software

2 Communication & interaction

3 SBC S-Web Technology



\* For the availability see chapter C2 Product status



## 2.6.2 LONWORKS® The building automation system field bus

### The standard for building services

LONWORKS® technology is a standardised communication protocol which is well-established in building and industrial automation systems. Properties such as the decentralised intelligence, modular design, requirement-based interfaces and the capability to adjust to existing infrastructures makes LONWORKS® an interesting option for the transfer of data in the field layer and for backbone systems. The individual network participants, the so-called nodes, are able to exchange event-controlled data among themselves. LONWORKS® forms the platform for manufacturer-independent communication in multi-service building automation systems.

### PCD systems

LONWORKS® is available as a communications option for practically all PCD systems. PCD classic controllers are connected to the Saia PCD® COSinus operating system via IP 852 (Ethernet). LON® FTT10 is also possible using a communication module, whereby each module supports max. 254 network variables. The PG5 contains a suitable LON resource configurator for configuring the LON nodes and an FBox library for commissioning, testing, transmitting and receiving network variables.

PCS controllers can be connected directly to an FTT10 using a communication option. Configuration also takes place in the PG5, whereby configurations of up to 800 network variables are permitted. A comprehensive Saia PG5® FBox library makes it possible to establish the connection to the application program for almost every type of standard network variable. A LON options module is always required for using the LON-over IP (IP 852). A PCD7.R58x is used for memory slots M1 or M2 for PCD3.M5/M6-, PCD2.M5-, PCD1.M2- and PCD1.M0 controllers. The PCD3.R58x module is available for I/O slots 0...3 for PCD3.M3 controllers without M1/2 slots.

### Recommendations/system limits

Model	Option	Interface	PG5 configuration, system limits
PCD3.M5560	1× PCD7.R58x* 4× PCD3.F240**	IP 852 FTT10	Recommended for configurations of up to 2000 network variables Suitable for BACnet® and LONWORKS® in parallel operation
PCD3.M5540 PCD3.M5340	1× PCD7.R58x*	IP 852	Recommended for configurations of up to 1500 network variables
PCD3.M3330 PCD3.M3120	1× PCD3.R58x*	IP 852	Recommended for configurations of up to 1000 network variables
PCD2.M5540	1× PCD7.R58x*	IP 852	Recommended for configurations of up to 1500 network variables
PCD1.M2xx0	1× PCD7.R58x* 2× PCD2.F240**	IP 852 FTT10	Recommended for configurations of up to 1000 network variables
PCD1.M0160	1× PCD7.R58x*	IP 852	Recommended for configurations of up to 1000 network variables
PCD1.M2020 Without Ethernet	2× PCD2.F240**	FTT10	Recommended for configurations of up to 500 network variables

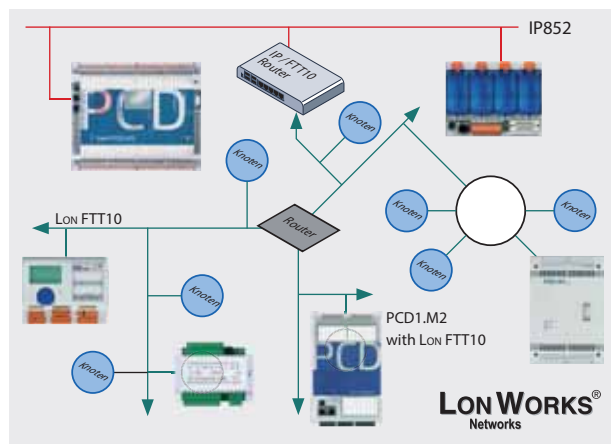

### Typical applications of a LONWORKS® infrastructure

- ▶ Heating, ventilation and climate control
- ▶ Light control
- ▶ Shading control
- ▶ Security
- ▶ Energy management, etc.

A "LON communication module" is also required to connect the LON FTT10. This module provides PCD controllers with a LONWORKS® interface but without a router function. PCD1.M2 controllers require the PCD2.F2400 module and PCD3 controllers the PCD3.F240 module.

External LON FTT10-/IP gateways are also required to connect FTT10 devices directly to the management system or other LON IP 852 devices, for example. In place of a router, the application program can also copy network variables on IP 852 via PCD resources from any system.



Standard Ports : #1628 And #1629

\* LON-over IP can only be used on PCD controllers with Ethernet interfaces. An external IP 852 config server is also required for commissioning and binding.

\*\* For information on the availability of the LON FTT10 communication module, see Chapter C2 Product status.



**LON IP and FFT10, efficient engineering with templates  
LON configurator**

**PG5 resources**

LON resource files (V13 XML)

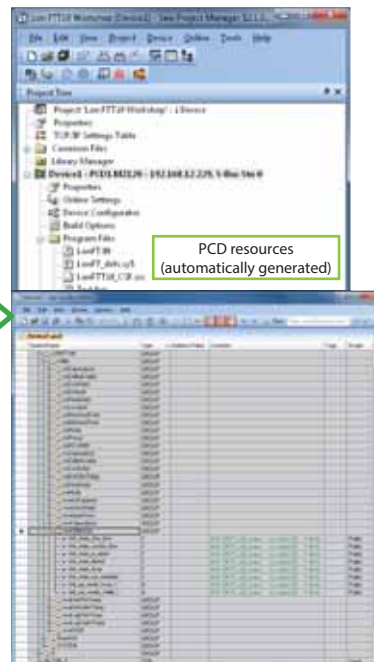
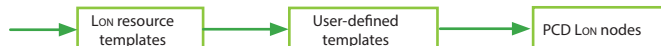
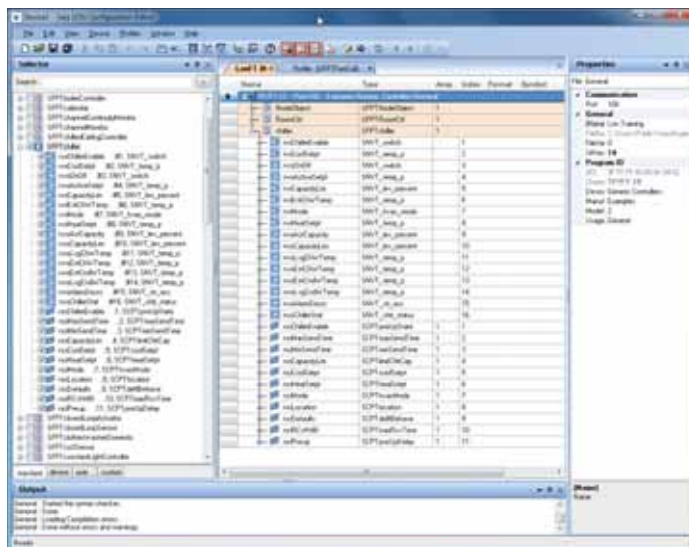
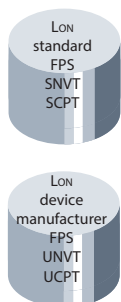

**Configurations**

Configuring a PCD host node can be very extensive depending on the size of the project. With little input, the system integrator is able to use the proven template concept to derive many hundreds of identical nodes from a single definition and automatically create PCD resources. Templates created by the device manufacturer and self-generated XML templates can be used. LONWORKS® standard templates can be supplemented in the LON IP configurator with additional information such as used resources, scaling, etc., and saved as separate templates. Templates created

this way can be combined in any manner and reworked again to create the LON nodes. This increased level of reusability of the templates makes engineering a decisive competitive advantage.

**Standard network variables SNVT**

Being implemented as an IP stack for the Saia PCD® COSinus operating system allows a single PCD substation to define up to 2000 SNVTs (standard network variable types) and link to other PCDs or third party systems. Almost all of the SNVTs currently specified in LONMARK® are supported by the PCD systems.

**Order information**

Model	Description
<b>LON-over IP for PCD3.M3xxx   PCD3.M5xxx and PCD3.M6xxx</b>	
PCD3.R580	Flash memory module with LON-over IP firmware for PCD3.M3120 and ..M3330, plug-in to I/O slots 0...3
PCD3.R582*	Flash memory module with LON-over IP firmware for PCD3.M3120 and ..M3330, incl. 128 MByte for program backup and file system, plug-in on I/O slots 0...3
<b>LON-over IP for PCD3.M5xxx   PCD3.M6xxx   PCD2.M5xxx   PCD1.M2xxx and PCD1.M0xxx</b>	
PCD7.R580	Flash memory module with LON-over IP firmware for PCD1.M2xxx, PCD1.M0xx, PCD2.M5xxx and PCD3.M5xxx/..M6xxx, plug-in to slot M1 or M2
PCD7.R582*	Flash memory module with LON-over IP firmware for PCD1.M2xxx, PCD1.M0xx, PCD2.M5xxx and PCD3.M5xxx/..M6xxx, incl. 128 MByte for program backup and file system, plug-in to slot M1 or M2
<b>LON FFT10 for PCD1.M2xxx   PCD3.M5x6x   PCD3.M6x6x</b>	
PCD2.F2400*	LONWORKS® interface module for up to 254 network variables with slot for PCD7.F110S, F121S, F150S, F180S
PCD3.F240*	LONWORKS® interface module for up to 254 network variables with slot for PCD7.F110S, F121S, F150S, F180S
<b>LON FFT10 for PCS1</b>	
PCS1.C88x	Freely programmable compact controllers with integrated LONWORKS® interface module

\* For information on the availability, see Chapter C2 Product status.

## 2.6.3 Modbus

# Modbus

Modbus is a communication protocol based on a master/slave or client/server architecture. It is wide-spread and supported by many manufacturers and devices. In many cases, Modbus is therefore the common denominator for transferring data between different devices and systems.

### Modbus with Saia PCD®

Modbus comes in three forms:

- ▶ Modbus ASCII data are transmitted in ASCII format via serial interfaces (RS-232, RS-485).
- ▶ Modbus RTU data are transmitted in binary format via serial interfaces (RS-232, RS-485).
- ▶ Modbus-TCP data are transferred in TCP/IP or UDP/IP packets via Ethernet.

### Supported Modbus function codes

- 1 Read Coils
- 2 Read Discrete Inputs
- 3 Read Holding Registers
- 4 Read Input Registers
- 5 Write Single Coil
- 6 Write Multiple Coils
- 7 Write Single Holding Register
- 8 Write Multiple Holding Registers

### Number of connections

Each Saia PCD® system is able to establish up to a maximum of 26 connections. Of these, the Saia PCD® controller is able to use a maximum of 10 for client connections. The remaining connections can be used as server connections to the same Saia PCD® controller.

### Application example

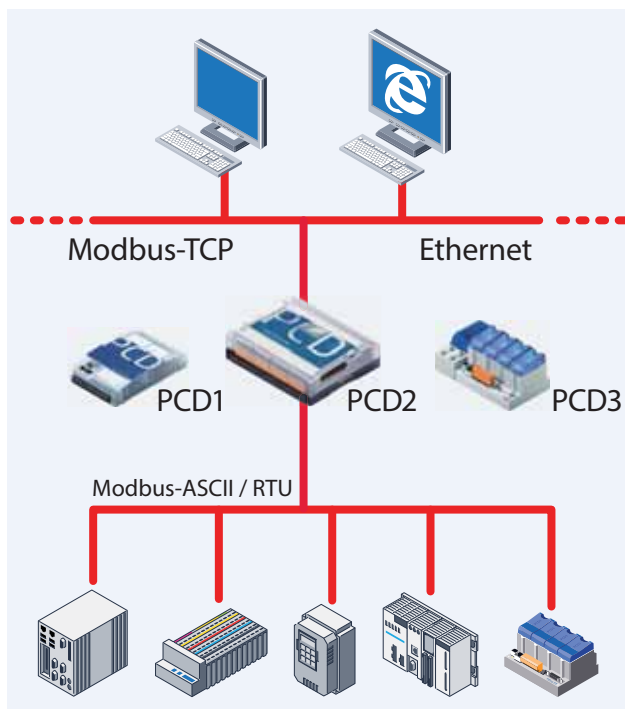

The Modbus protocol is supported in the Saia PCD® COSinus operating system by all Saia PCD1.M0\_, Saia PCD1.M2\_, Saia PCD2.M5\_ and Saia PCD3 controllers. Client and server functionalities are available for all types of protocol. Ethernet interfaces and serial interfaces (RS-232 and/or RS-485) are already included in the PCD controller basic devices. Additional plug-in interface modules can be used to operate up to 9 serial Modbus interfaces per PCD system.

Media Mapping: adjustable by the user  
 Mapping Areas: max. 10 pro UID  
 Number of servers: max. 4 per PCD system  
 Number of unit IDs: max. 10 pro PCD-System  
 Number of channels: max. 10 pro PCD System

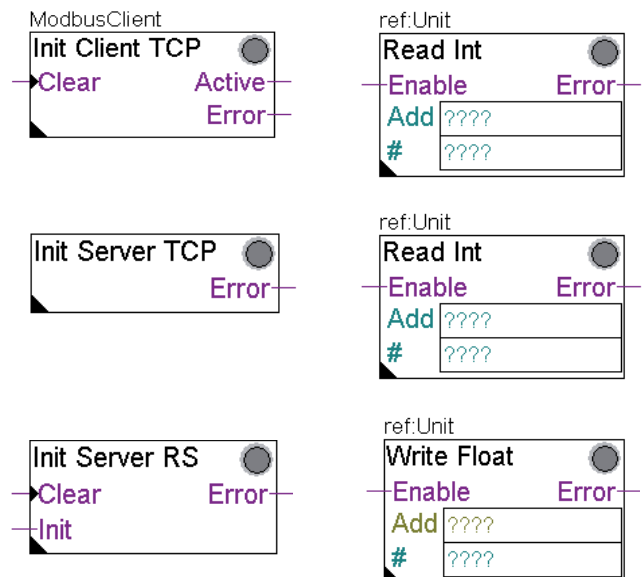

▲ Convenient Fulpa FBoxes or CSF commands are available for configuring and programming the exchange of data.

◀ Together with the integrated automation server, external systems can also be easily linked to master Web+IT automation environments via Modbus.

## 2.6.4 KNX

### Communication drivers for electrical systems and room automation

#### Communication drivers

An efficient networking of building services requires multi-service functions and components for communicating with external devices. The KNX communication driver is a PG5 FUPLA library with comprehensive function modules (FBoxes) for sending and receiving almost all of KNX data types (DPT). Depending on which interface is available for accessing the KNX network (RS-232 or Ethernet), the selected components can be linked to either Saia PCD® or PCS systems.

The direct connection via Ethernet makes access to KNX data even quicker and more powerful.

#### Features

- ▶ Use of drivers for all SBC automation stations
- ▶ Simple communication using Fulpa modules
- ▶ Comprehensive support of KNX Data Point Types (DPT)
- ▶ The drivers support the simple restructuring of existing systems with KNX-BCU1 on the KNX-BCU2 interface
- ▶ Standard UDP/IP port: #3671
- ▶ Communication drivers for:
  - ▶ Serial KNX BCU-1 interfaces via RS-232 (not recommended for new products)
  - ▶ Serial KNX BCU-2 interfaces via RS-232
  - ▶ KNXnet/IP (EIBnet/IP) communication

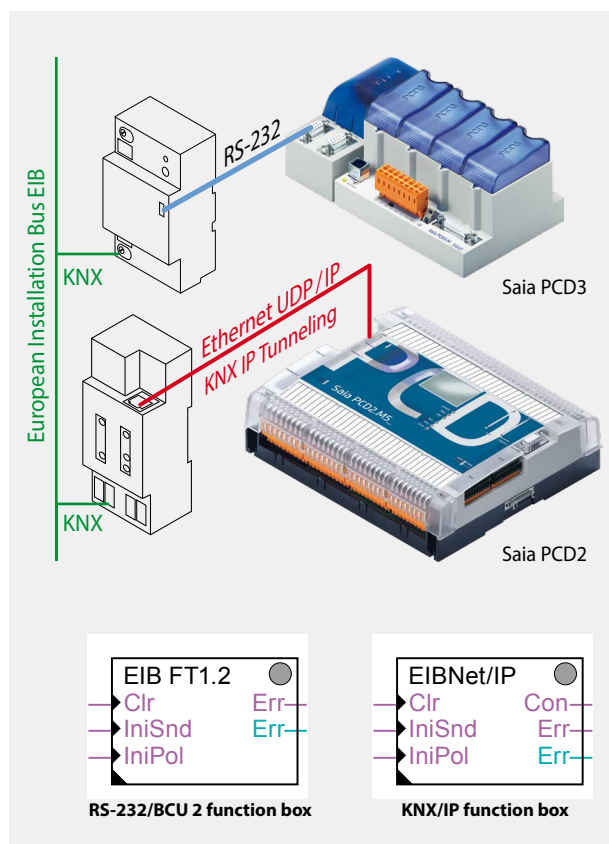

#### Order information

Model	Description
PG5-EIB	PG5-KNX/EIB (KNX standard) communication library for Saia PCD® and PCS controllers for serial and IP-based communication

#### Components of other providers

Weinzierl KNX IP Interface 730 ( <a href="http://www.weinzierl.de">www.weinzierl.de</a> )	KNXnet/IP-Gateway
Weinzierl KNX IP Router 750 ( <a href="http://www.weinzierl.de">www.weinzierl.de</a> )	KNXnet/IP incl. Router use
ABB IPS/S2.1 EIB/KNX IP Interface ( <a href="http://www.abb.com">www.abb.com</a> )	KNXnet/IP-Gateway
ABB IPS/R2.1 EIB/KNX IP Router ( <a href="http://www.abb.com">www.abb.com</a> )	KNXnet/IP incl. Router use
Weinzierl KNX BAOS 870 ( <a href="http://www.weinzierl.de">www.weinzierl.de</a> )	Serial (RS-232) KNX interface with BCU-2 protocol



#### Compatibility

As of 2012, the tried-and-tested SIEMENS® Gamma Instabus interfaces are no longer available. The actual devices are no more fully compatible. The interface from «Weinzierl Engineering GmbH» are recommended as a replacement.

#### Ethernet Gateways

When planning, it is important to take into consideration that some available Ethernet gateways usually only support one communication channel. As a result, every PCD or service tool, ETS for example, needs its own interface to the KNX-Bus.

#### Serial converter

However, connecting using BCU-1 protocols is strictly advised against. The BCU-1 protocol can cause telegrams to be lost between the gateway and the controller.

## 2.6.5 EnOcean

### Communication driver for wireless sensors and actuators



EnOcean is the inventor and manufacturer of the patented basic «self-powered wireless sensor technology». EnOcean was recognised as the first ISO/IEC wireless standard for optimised solutions with low energy consumption.

The “EnOcean alliance” is a manufacturers’ interest group which, over time, has developed a wide range of self-powered components for building automation systems based on EnOcean technology, such as switches, sensors, actuators and gateways,.

#### Communication driver

The EnOcean components are connected to the Saia PCD® controllers via external wireless gateways via serial RS-485 or IP interfaces. The FBox library provides communication modules for transmitting and receiving EnOcean telegrams.

Generic FBoxes are available for EnOcean devices. Device-specific FBoxes are available for manufacturer-specific devices, such as room control units (Sensortec, Thermokon and Omnio), which do not use the EnOcean standard profile. Universal communication FBoxes also offer the option of processing any EnOcean telegram in the PLC program.



#### Connection diagram for the RS-485 wireless receiver

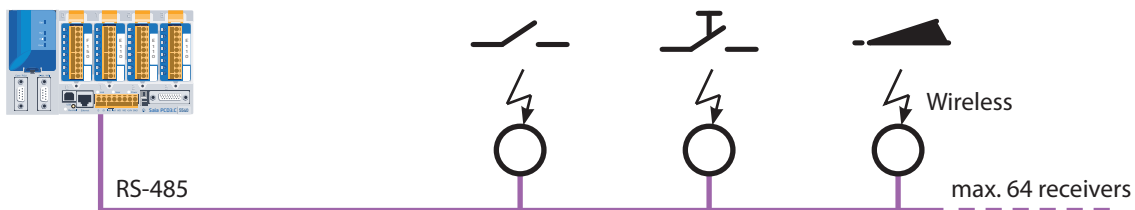

The number of transmitters per receiver is limited only by the distance and the reception quality.

#### Order information

Model	Description
PG5 – EnOcean	PG5 – EnOcean communication library for Saia PCD® and PCS controllers for serial (EVC-Mode) and IP-based communication.
Q.SRC65-RS 485E	EnOcean wireless receiver with RS-485 interface (unidirectional), IP65 casing with external aerial
Q.STC65-RS 485E	EnOcean wireless receiver/transmitter with RS-485 interface (bidirectional), IP65 casing with external aerial

#### Sensortec components ([www.sensortec.ch](http://www.sensortec.ch))

EOR700EVC	EnOcean wireless receiver with RS-485 interface (unidirectional), white IP20 casing with internal aerial and signal strength indicator
EOR710EVC	EnOcean wireless receiver/transmitter with RS-485 interface (bidirectional), white IP20 casing with internal aerial and signal strength indicator



The number of required wireless gateways depends heavily on the structural conditions. Pillars and furniture can create “dead spots” and walls can dampen the wireless signal depending on their design. Additional information and a brief planning guide are contained in the EnOcean manual (see [www.sbc-support.com](http://www.sbc-support.com))

## 2.6.6 M-Bus

### Field bus modules for capturing consumption data



#### M-Bus master interface modules

M-Bus (EN 1434-3) is an international standard for remote meter reading. The M-Bus connection is formed using the PCD2.F27x0 / PCD3.F27x communication modules in slots 0...1 on the PCD1.M2\* and 0...3 on the PCD2.M5 and PCD3. This makes it possible to capture all water, heat or energy quantities in an automation station. The measurement data is subsequently processed in an FBox library in the Saia PCD® FUPLA. The interface modules are fitted with a power supply and two separate M-Bus interfaces. Depending on the design, the integrated power supply is sufficient for up to 240 M-Bus standard slave modules whereby it can be distributed as required across the two ports.

 The PCD2.F2700 and PCD3.F270 M-Bus master modules are compatible with existing FBox libraries based on an RS-232 interface.

The PCD2.F2710...F2730 and PCD3.F271...F273 master modules require the Engiby M-Bus-Library.

FBoxes for SBC energy meters with M-Bus are supported by the Engiby library. The usage licence for these FBoxes is included in the basic package from PG5 2.0 onwards.

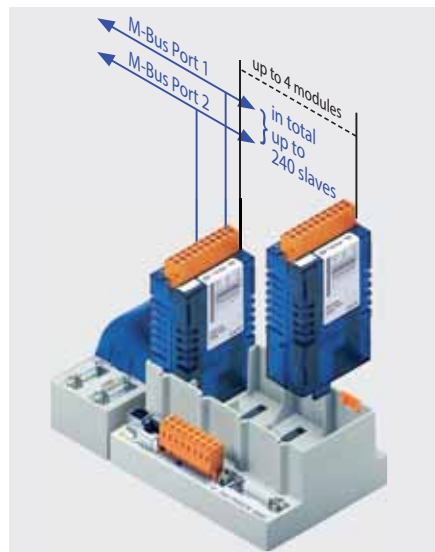

#### Usage

In PCD controllers, M-Bus is connected without a slot for M-Bus master modules via an external signal converter. RS-232 or RS-485 interfaces are used depending on the converter.

#### Driver settings

The respective PCD communication interface is specified in the Engiby library -Bus driver FBox. Attention should also be paid to the converter interface parameters such as Baud rate, time out, etc.

#### Driver license free

- M-Bus Drivers**
  - M-BUS Master
  - M-BUS Master Reset



#### Saia Energy Meters license

- M-Bus Electricity Saia**
  - Saia ALE
  - Saia ALE/AWD Extended
  - Saia AWD



#### Engiby M-Bus-Library, license required

- M-Bus Electricity**
  - M-Bus General
  - M-Bus Heating
  - M-Bus Water/Volume

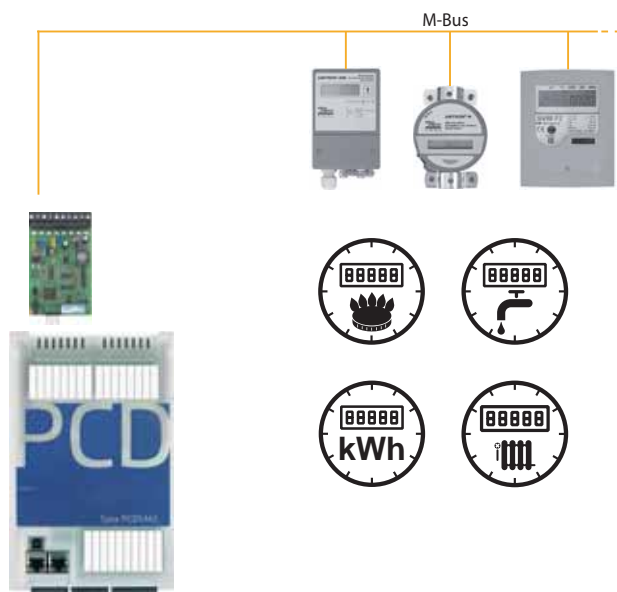

Application example: PCD1.M2120 with M-Bus activation.  
\* PCD1.M2110R1 Slot 0 only

#### PCD1/PCD2 ordering information

Model	Description	Weight
PCD2.F2700	M-Bus master interface for up to 240 slaves	60 g
PCD2.F2710	M-Bus master interface for up to 20 slaves	60 g
PCD2.F2720	M-Bus master interface for up to 60 slaves	60 g
PCD2.F2730	M-Bus master interface for up to 120 slaves	60 g



PCD2.F27x0

#### PCD3 ordering information

Model	Description	Weight
PCD3.F270	M-Bus master interface for up to 240 slaves	80 g
PCD3.F271	M-Bus master interface for up to 20 slaves	80 g
PCD3.F272	M-Bus master interface for up to 60 slaves	80 g
PCD3.F273	M-Bus master interface for up to 120 slaves	80 g



PCD3.F27x



## 2.6.7 DALI

### Field bus module for lighting systems



#### DALI master interface module

DALI is a communication system for lighting control, standardised according to IEC 62386-101/102. It was originally developed for stage technology and today it is used in a wide range of applications including building automation systems. Installation is easy. The DALI Bus simply needs 2 unshielded wires which can be threaded through the same cable together with the power supply, usually 230 V.

The light parameters are standardised. All upstream devices therefore have the same parameters for dimming, grouping and scenes, irrespective of the type of lighting.

The DALI master module includes the Bus power supply for up to 64 DALI participants. The extensive PG5 FBox library has function modules for commissioning, operating and servicing with the PLC program. External software tools or other components are not required.

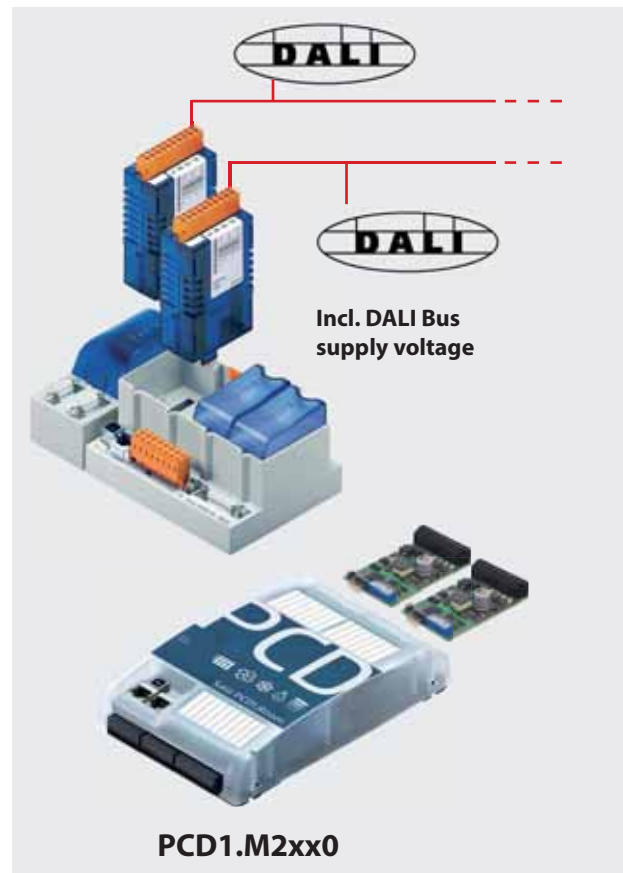

#### DALIF26x Driver

- Backup to Flash
- Configuration Manager
- DALIF26x Driver
- Edit Groups
- Edit Scene Levels
- Exchange addresses
- Get Status Range
- Query numeric
- Random addressing
- Read Memory
- Read Status
- Read Status Range
- Receive Commands
- Receive Raw
- Send Command Inputs
- Send Command Online
- Send Power Control
- Send Scene
- Write Memory

PG5 – DALI FBox library



PCD3.F261



PCD2.F2610

#### Order information

Model	Description	Application note	Weight
PG5 – DALI	PG5 – DALI communication library for connecting DALI lighting control systems	From PG5 2.0.220	---
PCD2.F2610	DALI master interface for up to 64 DALI devices incl. Bus power supply	PCD1.M2110R1: I/O slot 0 PCD1.M2xx0: I/O slot 0-1 PCD2.M5xx0: I/O slot 0-3	60 g
PCD3.F261	DALI master interface for up to 64 DALI devices incl. Bus power supply	PCD3.Mxxx0: I/O slot 0-3 PCD3.T666: I/O slot 0-3	80 g



SBC PCD® DALI master communication modules are supported from PCD firmware 1.16.48 and PG5 2.0.220 onwards. PCD firmware of version 1.19.21 and above is required to use the extended "DALI Multimaster" FBox library 2.6.010.



## DALI communication library

### Commissioning and servicing made easy

The "DALI F26x Driver" Fbox is positioned once when the program starts in order to initialise it. The "Configuration Manager" Fbox then parameterises all the DALI participants on the bus. The FBox also provides pre-defined symbols for extended use, e.g. in S-Web. The parameters can also be used securely in the PCD file system. The "Backup to Flash" FBox stores all DALI parameters in parallel in two files. This guarantees the retention of data in PCD systems without the need for batteries, e.g. in the Smart-RIO PCD3.T666.

When commissioning DALI systems, it is usual to install all DALI participants then issue the addresses and set the parameters via the DALI commissioning software. The "Random addressing" and "Exchange addresses" modules are available in the Saia PG5® – DALI library for this purpose.

Parameterisation takes place after the addressing process using the "Configuration manager" FBox. To provide a better overview, group and scene parameters can alternatively be set using the "Edit Groups" and "Edit Scene Levels" FBoxes.

### Operation

The "Send Command Inputs", "Send Command Online", "Send Power Control" and "Send Scene" FBoxes are available for transmitting DALI commands. These FBoxes cover all standard DALI commands.

The receipt of master telegrams is also supported by the "Receive Commands" and "Receive Raw" FBoxes. "Receive Raw" is useful for receiving non-standard telegrams. The raw data can then be processed further in the application program.

The lamp status can be requested using the "Read Status" FBox. The «Query numeric» FBox provides the application program with access to a further 21 DALI standard data points such as the current light level.

The "Read Memory" Fbox is used to read any of the data from a DALI device. It is therefore possible to request brightness and presence information from one sensor, which would not be accessible with the DALI standard methods.

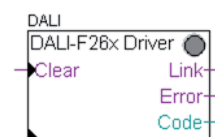

Driver module  
(1 × per interface)

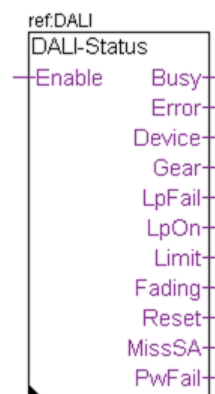

Status monitoring  
(1 × per monitored element)

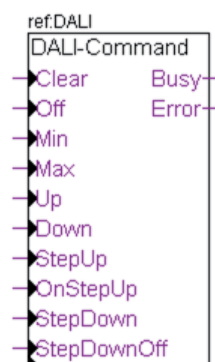

Lighting control on/off, dimmable  
(1 × per lamp/group)

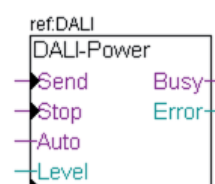

Lighting control direct  
(1 × per lamp/group)

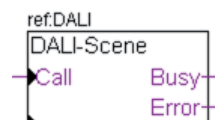

Scene controller  
(1 × per scene)



The current DALI standard does not guarantee a real multi-master function. Multi-master capable products such as those of Tridonic, Osram or Zumtobel are either based on the new draft DALI extension E DIN 62386-103 (2011-08), or accept the loss of telegrams in bus collisions. Permanent polling, e.g. of the status, should therefore be avoided in "multi-master" projects. The maximum number of DALI master devices can be restricted to 8 units, for example, depending on the product and hardware manufacturer.

## 2.6.8 MP-Bus Field bus module for Belimo MP-Bus devices



### MP-Bus master interface module

MP-Bus is a Belimo communication system used to connect Belimo MP-/MFT(2)\* field devices such as valve and shutter position drives or VAV controllers and room air sensors in building automation systems. Installation is easy. In addition to the 24V AC/DC power supply, the MP-Bus needs just one unshielded wire which can be run through the same cable.

Up to 8 drives can be attached to one communication channel. The total length of the mains cable depends on the diameter of the selected cable and the number and output of the connected drives\*\*. A total length of approx. 100 m is usually reached. Since the length of the connection and the number of drives is limited, no other demands such as termination resistors or shielded cable are placed on the bus topology.

In addition to the connected drives, sensors can be connected directly via a drive or MP-Bus add-on modules.

The extensive Saia PG5° FBox library has function modules for communicating with the PLC program. The drives are addressed using the communication driver FBox and can then exchange data with the application program via the respective FBoxes.

The Belimo components are usually commissioned from the application program using the SBC FBoxes. Only a few components such as VAV controllers require additional Belimo parameterisation tools to adjust their operational parameters.



PCD1 modular expansion with MP-Bus interfaces

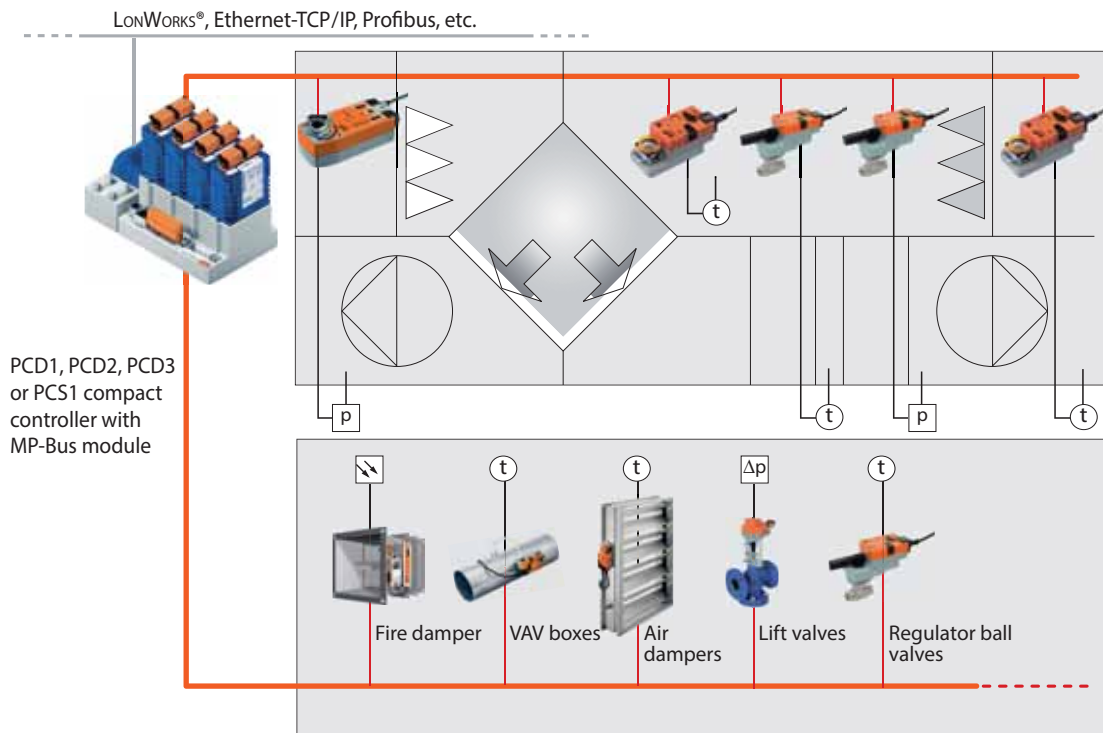

Application example: HVAC system with a PCD3.M5 and up to 64 MP-Bus drive units on 8 MP interfaces



















\* MP and MFT are Belimo designations. MP = Multi-point; MFT= Multi-functional technology

\*\* For further information on the system layout, see the Belimo documentation, [www.belimo.com](http://www.belimo.com)

# MP-Bus

## Overview

Automation station	On-board; Slot A, A1 and A2				I/O slot #0...#3			
	MP-Bus module	Total	Number of MP-Bus-		MP-Bus module	Total	Number of MP-Bus-	
			Cables	Drives			Cables	Drives
PCD3.M3xxx / M5xxx	---	---	---	---	PCD3.F21x, PCD3.F221, PCD3.F240	4	---	---
						+ PCD7.F180S	4	32
							4	32
PCD3.Compact   PCD3.WAC	PCD7.F180S	1	1	8	---	---	---	---
								
PCD2.M5xxx	PCD7.F180S	2	2	16	PCD2.F21x0, PCD2.F2210, PCD2.F2400	4	---	---
						+ PCD7.F180S	4	32
							4	32
PCD1.M2x20 and PCD1.M2x60	PCD7.F180S	1	1	8	PCD2.F21x0, PCD2.F2210, PCD2.F2400	2	---	---
						+ PCD7.F180S	2	16
							2	16
PCD1.Room	PCD7.F180S	1	1	8	PCD2.F21x0, PCD2.F2210, PCD2.F2400	1	---	---
						+ PCD7.F180S	1	8
							1	8
PCD1.M0160E0	PCD7.F180S	1	1	8	---	---	---	---
								
PCS1.C4xx / .C6xx / .C8xx	PCD7.F180S	1	1	8	---	---	---	---
								

## MP-Bus | Function modules (FBox)



All Belimo MP drives can exchange data with the PCD application program via a suitable FBox from the MP-Bus FBox library. The master communication FBox has to be positioned once at the beginning of the application program. It controls the communication and fault recognition and also makes methods for addressing the MP drives available for commissioning and service.

Type/performance categories	Figure	Sensors	MP-Bus FBox
<p><b>Communication drivers</b></p>			
<p><b>Ventilation applications</b></p> <p>Damper drives without safety function: LM24A-MP (5 Nm), NM24A-MP (10 Nm) SM24A-MP (20 Nm), GM24A-MP (40 Nm)</p> <p>Damper drives with safety function: TF24-MFT (2 Nm), LF24-MFT2 (4 Nm), SF24A-MP (20 Nm)</p> <p>Damper drives linear: LH24A-MP100 / 200 / 300 (150 N) SH24A-MP100 / 200 / 300 (450 N)</p> <p>Damper drives rotary: LU24A-MP (3 Nm)</p>			
<p><b>Safety applications</b></p> <p>Drives for fire dampers: BF24TL-T-ST (18 Nm) BFG24TL-T-ST (11 Nm)</p> <p>Gateway for conventional fire damper drives: BKN230-24-C-MP</p>			
<p><b>Room and system applications</b></p> <p>VAV compact controller: LMV-D3-MP (5 Nm), NMV-D3-MP (10 Nm) SMV-D3-MP (20 Nm)</p> <p>VAV compact controller linear: LHV-D3-MP (150 N)</p> <p>VAV universal controller: VRP-M</p>			
<p><b>Water applications</b></p> <p>Lift drives without emergency function: LV24A-MP-TPC (500 N), LVC24A-MP-TPC (500 N), NV24A-MP-TPC (1000 N), NVC24A-MP-TPC (1000 N), SV24A-MP-TPC (1500 N), SVC24A-MP-TPC (1500 N), EV24A-MP-TPC (2500 N)</p> <p>Lift drives with emergency function: NVK24A-MP-TPC (1000 N), NVKC24A-MP-TPC (1000 N), AVK24A-MP-TPC (2000 N) Closing point adjustable, emergency setting adjustable</p> <p>Drives for control ball valve without emergency function: LR24A-MP (5 Nm), NR24A-MP (10 Nm), SR24A-MP (20 Nm)</p> <p>Drives for control ball valve with emergency function: TRF24-MFT* (2 Nm), LRF24-MP (4 Nm), NRF24A-MP (10 Nm), SRF24A-MP (20 Nm)</p> <p>Drives for butterfly valve without emergency function: SR24A-MP-5 (20 Nm), GR24A-MP-5/-7 (40 Nm)</p>			 

\* only active sensors and switches can be connected

# MP-Bus | Function modules (FBox)

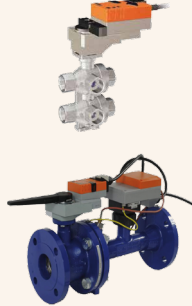
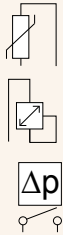
Continued

Type/performance categories	Figure	Sensors	MP-Bus FBox
<p><b>Water applications (continued)</b>                      Drives for 6-way control ball valve:                      LR24A-MP (5 Nm)                      NR24A-MP (10 Nm)</p> <p>Electronic pressure-independent control ball valve (EPIV):                      P6..W..E-MP</p>			<pre> ref:Channel MP 6 Way -En Err -Res Sen -Cool SEr -Heat Pos Me1 Me2 Me3 DAAd ????  ref:Channel MP EPIV20 -En Err -Res V% -Vol Vol -Opn Sen -Cls Pos Me1 Me2 Me3 DAAd ????                     </pre>
<p><b>Room sensors</b>                      Room combi-sensor, depending on design with temperature, CO<sub>2</sub>, VOC and relative humidity:                      MS24A-R..-MPX</p>			<pre> ref:Channel MP THCV Sensor -En Err Tmp Hum CO2 VOC VOCg VOCt Flush Aln Dln ErrT ErrH ErrC ErrV DAAd ????                     </pre>
<p><b>Generic data transfer</b>                      For reading and transmitting data points not contained in the device-specific FBox. This FBox is used as a functional extension for MP-Bus FBoxes and can only be used together with a device FBox specific to that device or a generic device FBox.</p>			<pre> ref:Channel MP PEEK -En Err -Val Val DAAd ????  ref:Channel MP POKE -En Err -Val Val DAAd ????                     </pre>
<p><b>Third party devices</b>                      FBoxes are available for the following third party MP-Bus devices                      PTH sensor from wmag AG, Switzerland                      UST-3, UST-5 from wmag AG, Switzerland</p> <p>Each MP-Bus device can also be connected via generic devices and peek/poke FBoxes in PCD application programs.</p>			<pre> ref:Channel MP PTH -Res Err Wrn Def Hum  ref:Channel MP UST 3 -En Err -Vlt Sen R11 SEr R12 U1 R13 U2 In1 U3 In2 In3 DAAd ????  ref:Channel MP Generic -En Error DAAd ????  ref:Channel MP PEEK -En Err -Val Val DAAd ????  ref:Channel MP POKE -En Err -Val Val DAAd ????                     </pre>

## 2.6.9 Other drivers

### www.engiby.ch communication drivers

Field bus, standard/universal interfaces	
Schneider Modbus	Schneider, Modicon and Telemecanique and many other devices via point-to-point connections – modem – RS-232 – RS-422 – RS-485 Bus – TCP/IP – UDP/IP
M-Bus	Heating cost meter, water meter, impulse meter, electricity meter
3964(R) / RK512	Siemens: Point-to-point and multi-point connection
S-Bus for TCP/IP	S-Bus driver for multi-master applications
S-Bus for RS-xxx	S-Bus driver for quick response time with priority
S-Bus for modem	S-Bus driver for modem applications with high level of reliability and security
ESPA 444	Message send
	Message receive
	Message forward and route via SMS, pager or TAP
IEC 870-5-101	Power plant/energy management
IEC 870-5-103	Switching station controller
IEC 870-5-104	Power plant/energy management
Text output	Configuration tool for transmitting formatted text event-controlled via serial interfaces, TCP or UDP. Also supports SMS and Syslog messages
Text parser	Configuration tool for reading and analysing PCD text input
SNMP trap	Alarms/notification (NMS)
EIB	Configuration tool for the Saia EIB communication driver
<b>Controller/energy</b>	
ExControl	Light and shading functions with remote access via RS-232 or Ethernet
Menerga	Menerga controller
APC	Uninterrupted power supply
TRSI	WITnet concept, remote control
COMSAB / York	SABROE compressor control device:
	– PROSAB II
	– UNISAB S / R / RT / RTH
Luxmate	Lighting controller BMS ZUMTOBEL
<b>Alarm/messages/access</b>	
Cerberus	Siemens-Cerberus alarm systems (extended driver)
DMS 7000	Siemens-Cerberus alarm systems (reduced driver)
Tyco MX	Tyco MX 1000 and 4000 alarm systems
Zetadress	Tyco Zetadress intrusion detection system
Fidelio / FIAS	Hotel management system
Securiton, BMA, EMA	Fire and burglar alarm system
TechTalk	Access control system
<b>Video / Audio</b>	
Ernitec	Video matrix control
Dalmeier P-serial	Video control panel
Grundig VAZ	Video matrix
Commend	Interphone-System
<b>Other</b>	
Wilo/EMB	Pump controller
Grundfos pump control	Genibus via RS-485
	G100 gateway via RS-232 and Profibus-DP
ebmBUS	ebmPapst motor controller
Clock and GPS	Time signals received for DCF77 - Time and position received via GPS
	Time and mete data received from Elsner station
Marksman	Road traffic counter

### Saia Burgess Controls communication drivers

P-Bus	Communication driver to Siemens P-Bus I/O layer
N2-Bus	Communication driver to JCI-N2-bus for connecting JCI master or slave systems

### For German-speaking customers: Communication drivers from Kindler Gebäudeautomation GmbH, www.kga.de

<b>Danfoss</b>	
KGA.Danfoss	FBox library for communicating with VLT 6000 / FC100 Danfoss® frequency inverters with the standard FC communication protocol



# B3

## SBC S-Web Technology

Automation systems with sophisticated SCADA functions “embedded” in every device.

- ▶ Alarming
- ▶ Trending
- ▶ Visualising
- ▶ Standard web browser as service interface



### 3.1 The aim of S-Web: Using what you know and what already exists

Page 224

No need to continue using proprietary SCADA/management PC software. Each interest group gets exactly what it needs; there's nothing unnecessary to confuse the user. Current end devices and existing already mastered on-site technology is sufficient.

### 3.2 The S-Web system architecture: SCADA in every automation device

Page 225

The functional basic structure of a single automation device is used to illustrate how SBC S-Web systems are designed for machines, plants and distributed properties.

### 3.3 Real life examples of SBC S-Web

Page 227

Four projects are presented to illustrate how thousands of S-Web systems have been implemented in the field. They explain how the systems move from design to realisation and operation.

### 3.4 Engineering Information

Page 229

What should You know when realising and integrating SBC S-Web system?  
How do they differ from conventional PC-based SCADA/HMI solutions?

### 3.5 Tender information – what changes with S-Web

Page 233

The typical tender for automation/ICA systems still involves the current strict separation of control engineering and process control and management functions on separate layers. SBC S-Web combines different functions in a single device. This can also be seen in the tenders.

### 3.6 SBC S-Web system tools and products

Page 237

What is available from SBC? How are system components of other manufacturers incorporated?  
What software tools are available for creating projects?

### 3.7 Using Automation Server as a technical basis

Page 241

Automation Server functions in every SBC device are the technical requirements for SBC S-Web systems. What sort of functions are they? What benefits do they provide?

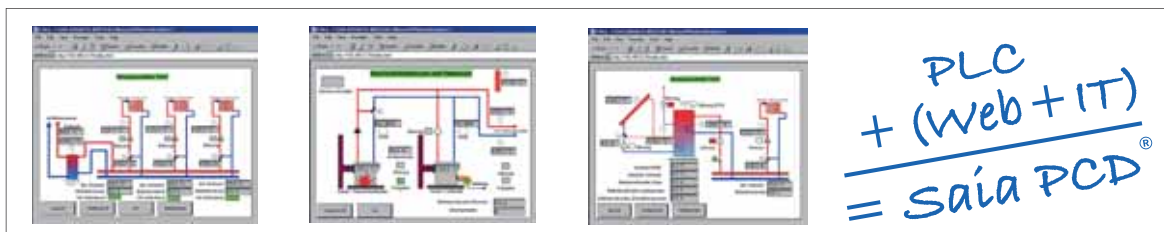

▲ Practical example of Web HMI pages created using Saia PG5® Web Editor

### 3.1 The aim of S-Web:

Using what you know and what already exists. Using less of the unknown and complex.

We as a company, and our technology are focused on being as lean as possible. The aim of being lean is to achieve ever more using less. That is only possible by using what you already have to the max. As little as possible should be introduced on top of this. SBC S-Web is completely aligned to this principle.

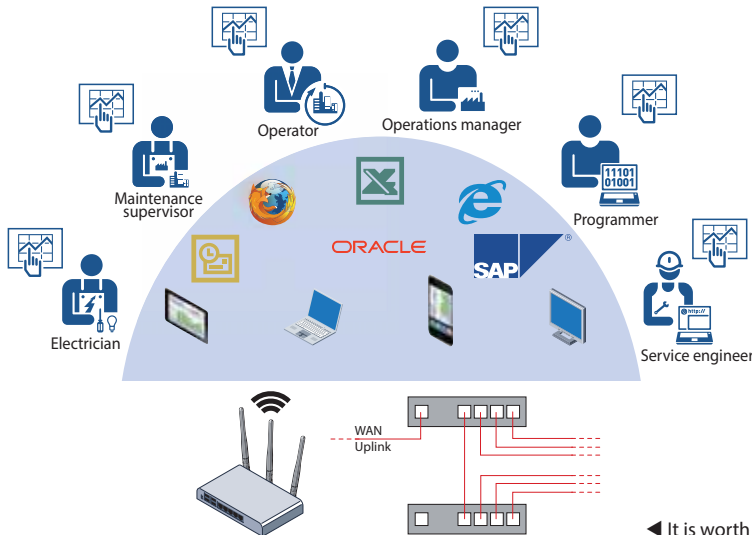

#### SBC S-Web optimises use of

- ▶ existing software
- ▶ existing personnel resources
- ▶ existing infrastructure and end devices

#### SBC S-Web systems

- ▶ make special SCADA Software unnecessary
- ▶ reduce the need for trained personnel in the operation
- ▶ make an investment project simpler and more favourable

◀ It is worth using what already exists on site to the max. There is already so much there.



**Software:** Management functions can be solved using dedicated software. This has to be purchased, installed, configured, maintained and educated/trained. It can usually do far more than it is actually used for and is therefore complex. SBC S-Web makes such dedicated management/SCADA software unnecessary. Simply use the software which is already available everywhere.



**Human resources:** Monitoring, control and management functions are possible for all interest groups/individuals. Everyone is able to optimise their area of responsibility in a way tailored to them. No-one needs to be an automation specialist, no-one needs special tools, no-one has to wait to carry out analysis or improvements.



**Infrastructure and end devices:** SBC S-Web can be integrated simply and safely in existing LAN/WAN infrastructures. Practically all existing end devices can be used. This raises acceptance and reduces expense. This is possible by providing each control unit with sophisticated SCADA functions via many globally recognised technical standards.

#### Using what already exists?

- ▶ Use less of the new, unknown and complex as possible



PLC  
+ (Web+IT)  
= Saia PCD®



S Web

In order to realise SCADA/management/operating functions using SBC S-Web, only those technologies are used which already exist and have been mastered on site. They are globally recognised, non-proprietary Web+IT standards. The required functions can be flexibly adapted over the entire life cycle of a system and kept simple to master. This is possible because the basic characteristics of the classic PLC technology are also integrated in the S-Web systems. A unique combination!

## 3.2 The S-Web system architecture: SCADA functions in every automation device

The conventional ICA automation device just regulates and controls. The third essential core component, the SCADA function, is outsourced and realised "elsewhere". Ten years ago, this was a practical solution since memory and processor power were expensive and limited. Since then, memory and performance have become cheap. All the functions necessary for the automated system can now be realised in a single device as a single project. Today, each new Saia PCD® has better performance and more memory than a normal desktop PC from the year 2000.

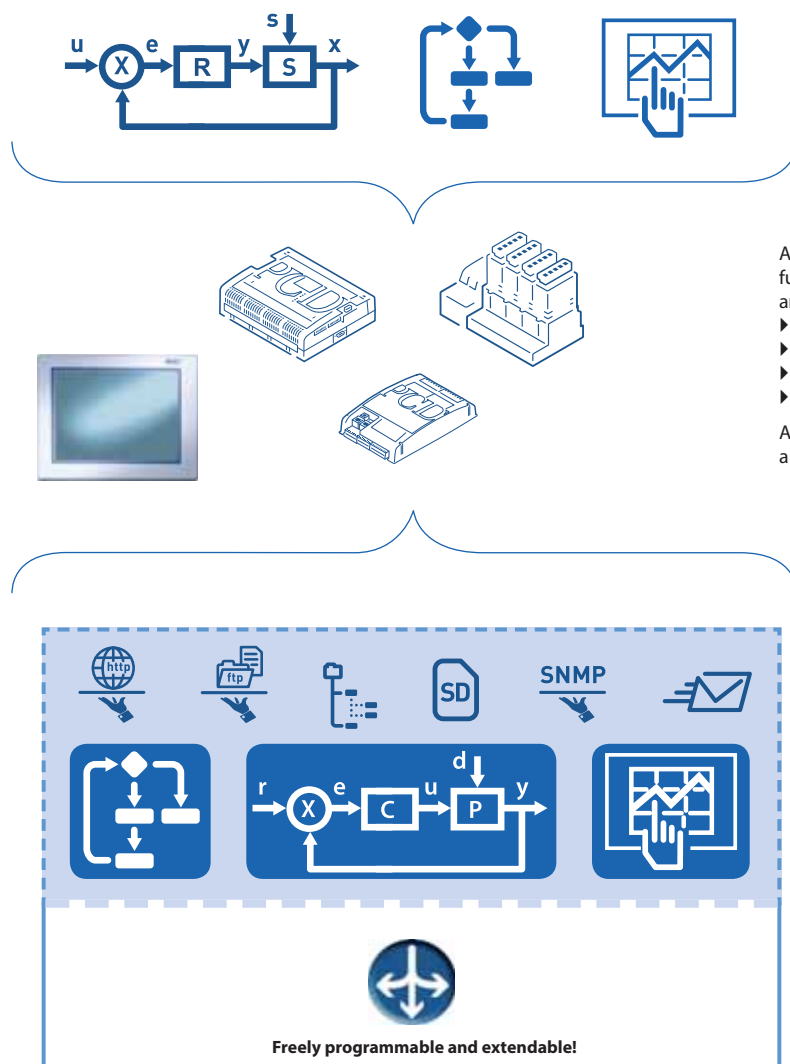

▲ **Functional design of Saia PCD® control units:** The entire automation application is on board. The combination of globally standardised, non-proprietary Web+IT functions known as Automation Server form the interface to the environment. The freely programmable design and modular extensibility of the controller ensure the "perfect fit" for current task formulation over a life-cycle of 15-20 years, without the need for new investment.

## For the benefit of the users and operators of plants / properties

► Technological advancement creates huge structural changes in the automation pyramid

**Previously,** only PCs had the necessary resources for management/control functions. The SCADA/management software was loaded onto them. The automation/field levels were closely linked using bus systems. This has since become outdated.

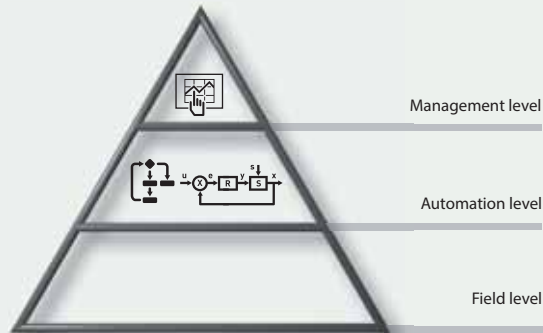

**Today with SBC S-Web:** Every unit has its own fully integrated automation function. Even simple field installations now already have their own SCADA function which guarantees local optimisation and reliable operation. There are short paths and direct exertion of influence. Control/management functions do not have to be laborious and expensive by the data transfer running through the automation layer to the management layer and back.

All automation functions (control and management functions) are integrated in every device

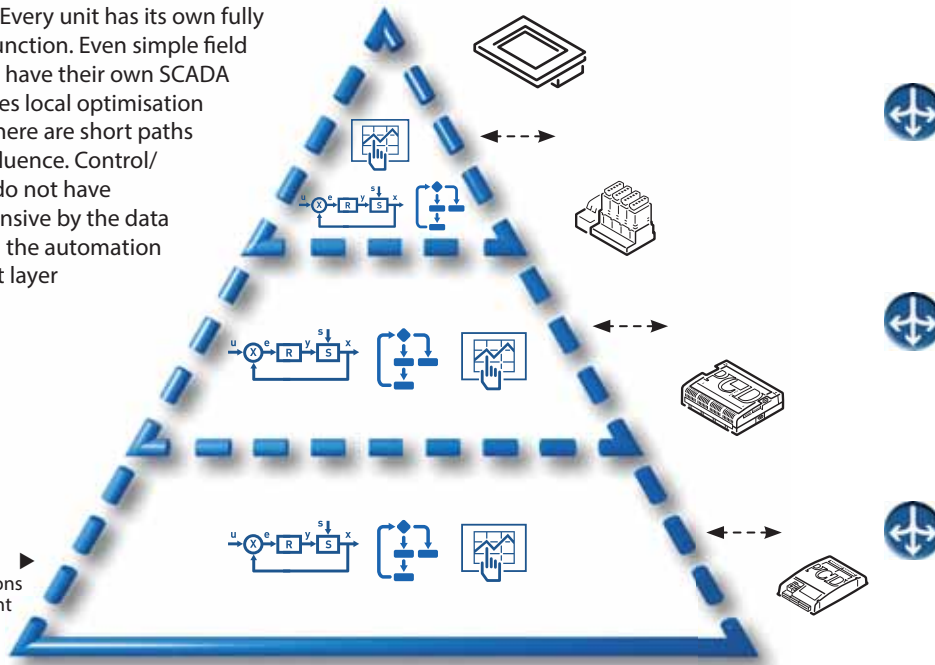

Saia PCD® devices can be freely programmed and extended with Saia PG5 across all levels and throughout the entire life-cycle.

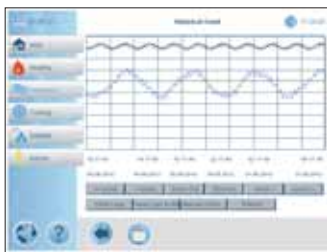

▲ SBC S-Web Trending



▲ SBC S-Web Alarming

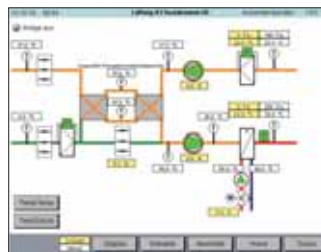

▲ SBC S-Web System Visualisation



▲ SBC S-Web Service Interface

↓ SBC S-Web standard application in live operation: [www.pcd-demo.com](http://www.pcd-demo.com)

**BACnet has a comparable system model:** BACnet is the only globally recognised and widely spread standard for building automation systems. It is based on exactly the same system model as Saia-PCD units. However, SBC S-Web realises the management/control function in buildings with the combination of the known =PLC +Web+IT; without introducing another standard to a building.





## 3.3 Real life examples of SBC S-Web

### Marc Cain Building

Bodelhausen/Germany

POM-certified HVAC system (Peace Of Mind) and room control technology for the head office of this international fashion company provides a better climate and low energy consumption.



The performance requirements for the automation of the building were set at a high level right from the beginning with the aim of achieving "Peace of Mind" certification from TÜV. Thanks to this approach, the design study integrated all the HVAC aspects of the building into one single, flexible control project. The thermal energy, for example, is produced by various sources and its distribution is controlled to minimise energy consumption. In a complex installation, this is only possible thanks to the ability of the control system to integrate seamlessly all devices independently of their communication capabilities.

The Marc Cain system comprises 25 automation devices. 24 Saia PCD3.M5x40 cover the individual system components/sub-sections. One Saia PCD3.M5x60 forms a master control/management level for the entire property. Now any browser device in the network (LAN/WAN) can be used to access the local operator application of each individual system or even directly access the control/management application of the master Saia PCD3.M5x60. Complex system schematics naturally require suitably sized displays; a PDA/mobile phone is not large enough for this.

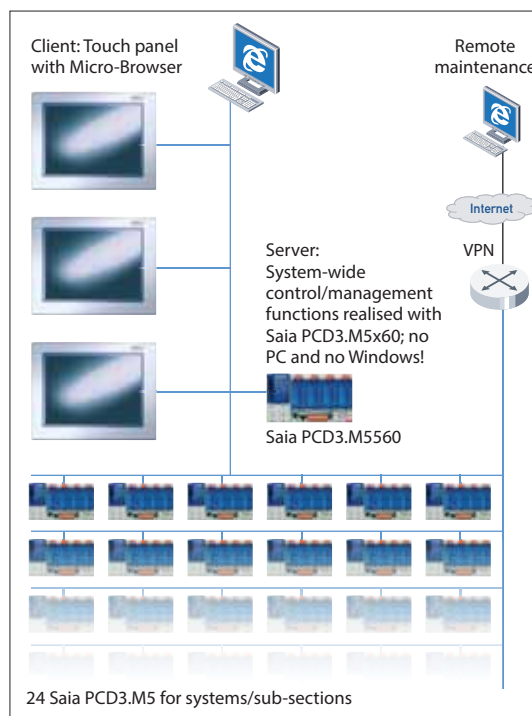

### Lucerne Conference Centre

Lucerne/Switzerland

The renovation and expansion of the Lucerne Conference Centre achieved the Minergie Standard and revitalised this important meeting place.



The 13,000 m<sup>2</sup> of the four halls of the Lucerne Conference Centre provide the most modern technological exhibition area able to meet all usage requirements. The range of different events also require a flexible architecture for lighting, ventilation and air conditioning in order to comply with the energy efficiency requirements of Minergie-certified conference centres. The extensive usage of bus technology in the planned building services, such as DALI for the lighting and MP Bus for the HVAC, allowed it to be integrated into the Saia PCD® controller with little effort and operated using web technology. The very high level of flexibility of our programmable controllers and a design based on open-web technology which made high levels of investment in expensive visualisation systems superfluous, were crucial to the award.

The Lucerne Conference Centre operating and monitoring concept is based entirely on SBC S-Web. It does not require a PC/Windows-based control or management system. Trend data are recorded directly in the automation device and visualised using the available web templates. The system comprises 2000 physical data points distributed among eight PCD3.M3330 automation devices. There are eight 10" Micro-Browser devices installed per system component for operational purposes. There are three 15" web panels with the Windows CE operating system for providing a global overview.

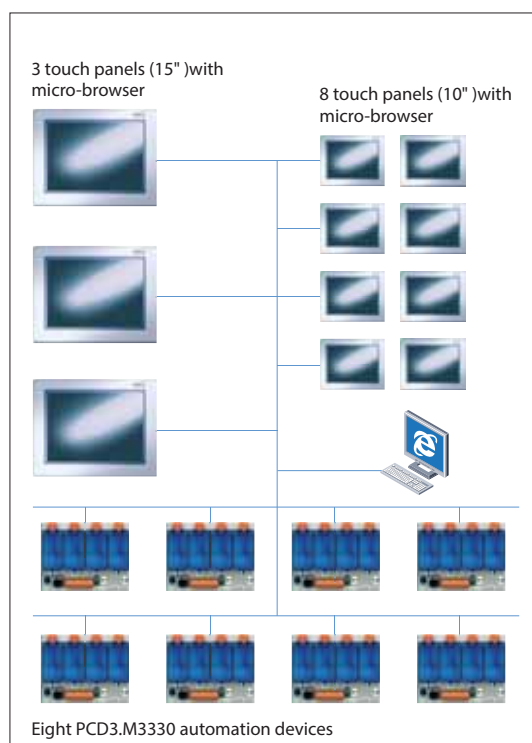

## Academic Medical Centre

Amsterdam/Netherlands

One of the top ten academic hospitals in the world relies on Saia PCD® controllers for a better climate and reduced energy consumption

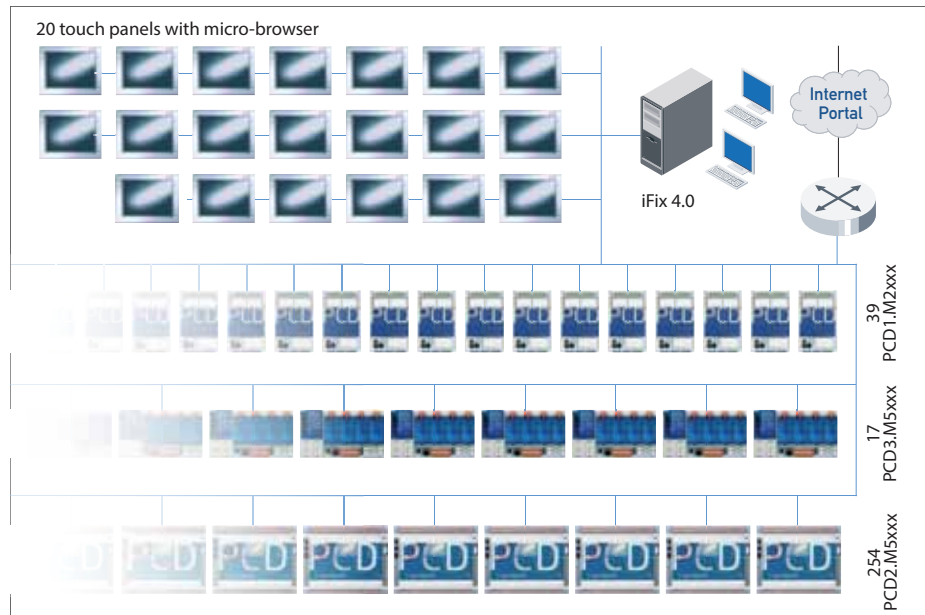

AMC wanted to refurbish and extend the controls systems, step by step, over several years, without fearing the costs and difficulties of possible changes in automation station generation. They started using Saia PCD® controllers in their buildings, processes and utilities in 2000. More than 10 years later, the choice is still considered as the right one. This is supported by the transparent integration of the newest Saia PCD® generation, the general use of Ethernet, data logging on flash and the reliability of the installed base. The communication capabilities of Saia PCDs which make it possible to connect to all systems make the life of the system integrator simpler.

▲ The local conditions in the individual parts of the system and building were resolved in this application using S-Web. A total of 310 automation stations (Saia PCD®) are integrated in the property automation system. The entire clinic is operated, controlled and managed as a functional unit. In hospitals, the high volume of visitors and the ventilation/cooling system are "mission critical". In this respect it is therefore preferable to operate a central iFIX 4.0 PC/Windows-based control/management system parallel to SBC S-Web. SBC S-Web is not able to make the classic SCADA software completely superfluous in this instance.

## European Research Centre CERN

Geneva/Switzerland

The entire enormous CERN site consisting of 430 operational buildings relies entirely on SBC S-Web.

Thanks to Web+IT standards, it has no need for a dedicated central office or master control/management layer.



Around 10,000 people work in the 430 buildings at CERN. Each building is fully independent. SBC S-Web forms their control/management layer. There is no need for dedicated SCADA software/PC hardware. The existing and already mastered CERN Web+IT technology is sufficient for integrating the consumption data across the site and for monitoring purposes. Operation of the building technology does not require the purchase of, installation of or training on dedicated Windows software. Automation projects are awarded by CERN throughout Europe. Thanks to SBC S-Web, system integrators all over Europe are able to realise autonomous projects for CERN or improve existing systems. There is no need to involve or reintegrate a central BMS application.



With S-Web, CERN benefits from a technology it discovered itself in 1989.

Source: Wikipedia



### 3.4 Engineering information

Which resources does a Saia PCD® require for SBC S-Web?

#### The basic structure of an operational S-Web system

The basic structure is simple. Enter the device addresses in the client. The Automation Server of the Saia PCD® devices makes the application/Saia PCD® data available. How large and comprehensive can this be in the various types of Saia PCD® devices?

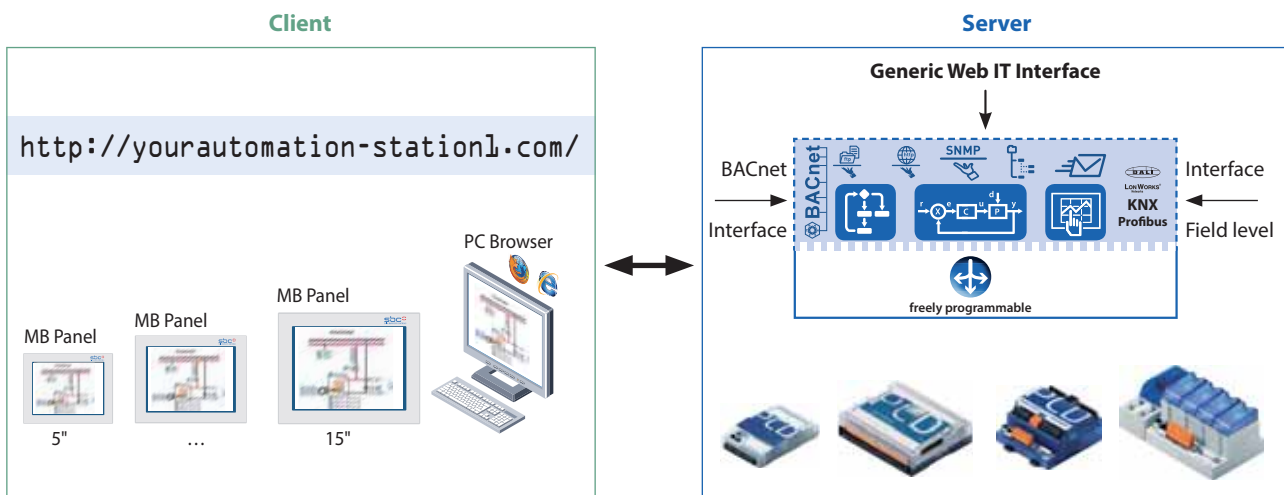

Browser device Which display size?  
Which display resolution?  
Which device type?

The browser device is usually determined by the mounting/  
installation location and the requirements in terms of display size  
and resolution.

Saia PCD® controller application server How many data points?  
How many trends?  
How many images/elements?

The type of controller is determined by the number of required inputs/  
outputs, the range of functions and the memory requirements.

#### Basic orientation: device selection

Every fully independent functional automation system can be illustrated as a hierarchy in the classic form of a pyramid. The differences between systems lie in the scope/power of the respective applications. In other words, the range of required functions and connected field layers.

Large, complex sites can generate large pyramids with 2-3 hierarchical layers. The resources must be designed according to the size of the pyramid and the position at which a Saia PCD® automation device is used. The ability to move Saia PCD® applications to all three basic platforms and the high modularity even with regard to extending the memory capacity means that SBC S-Web systems can be continuously extended even after they have been commissioned. The following illustrates a good basic orientation to ensure the initial installation is already well suited.

#### Basic applications

- ▶ Up to 50 I/O
- ▶ Up to 20 trends
- ▶ Up to 100 alarms
- ▶ Up to 30 web-pages

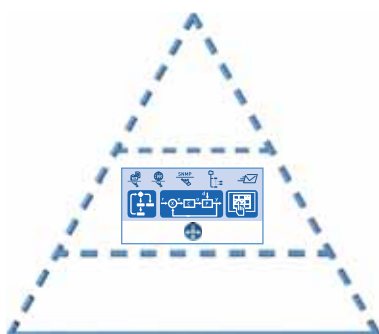

Saia PCD® controller	Max. I/O	Program memory	Onboard Flash memory	Additional memory	
PCD1.M2120	50	128 kByte	8 MByte <sup>1)</sup>	1× PCD7.R550M04 <sup>1)</sup>	1× 4 MByte
PCD1.M2160	50	1 Mbyte	128 MByte <sup>2)</sup>	1× PCD7.R550M04 <sup>1)</sup>	1× 4 MByte
PCD3.M2130V6	102	512 kByte	1 MByte <sup>1)</sup>	---	---
PCD3.M2230A4Tx	78	512 kByte	1 MByte <sup>1)</sup>	1× PCD7.R-SDxxxx <sup>1)</sup>	1× 1 GByte
PCD3.M3xxx	1023	512 kByte	---	4× PCD3.R550M04 <sup>1)</sup> 4× PCD7.R-SDxxxx <sup>1)</sup>	4× 4 MByte 4× 1 GByte

<sup>1)</sup> 900 files per memory module  
<sup>2)</sup> 2400 files per onboard memory



The Saia PCD® controls and visualises a machine, a simple building with a ventilation system, a heating circuit or a complex room, etc.

### Mid-level applications

- ▶ Up to 500 I/O
- ▶ Up to 60 trends
- ▶ Up to 1000 alarms
- ▶ Up to 100 web-pages

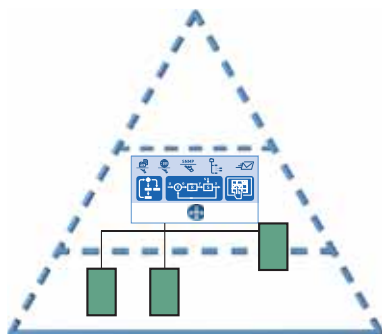

Saia PCD® controller	Max. I/O	Program memory	Onboard Flash memory	Additional memory	
PCD3.M5xxx	1023	1 MByte	---	2× PCD7.R550M04 <sup>1)</sup> 4× PCD3.R550M04 <sup>1)</sup> 4× PCD7.R-SDxxx <sup>1)</sup>	2× 4 MByte 4× 4 MByte 4× 1 GByte
PCD2.M5xxx	1023	1 MByte	---	2× PCD7.R550M04 <sup>1)</sup> 4× PCD3.R550M04 <sup>1)</sup> 4× PCD7.R-SDxxx <sup>1)</sup>	2× 4 MByte 4× 4 MByte 4× 1 GByte

<sup>1)</sup> 900 files per memory module

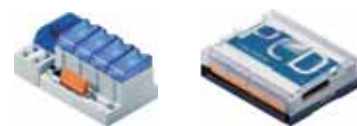

◀ The Saia PCD® controls several system components and includes the SCADA/visualisation functions of the entire system/all parts of the building

### Top-level applications

- ▶ Up to 2500 I/O (entire system)
- ▶ Up to 120 trends
- ▶ Up to 2000 alarms
- ▶ Up to 300 web-pages

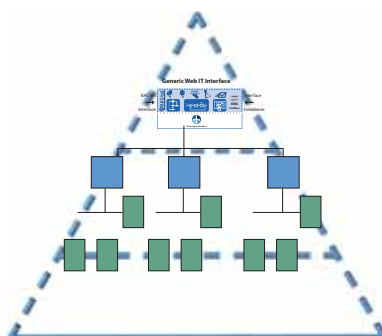

Saia PCD® controller	Max. I/O	Program memory	Onboard Flash memory	Additional memory	
PCD3.Mxx60	1023	2 MByte	128 MByte <sup>2)</sup>	2× PCD7.R550M04 <sup>1)</sup> 4× PCD3.R550M04 <sup>1)</sup> 4× PCD7.R-SDxxx <sup>1)</sup>	2× 4 MByte 4× 4 MByte 4× 1 GByte
PCD7.D4xxxT5F	---	1 MByte	128 MByte <sup>2)</sup>	---	---

<sup>1)</sup> 900 files per memory module

<sup>2)</sup> 2400 files per onboard memory

Client & server in one device: The Saia PCD7.D4xxxT5F micro-browser panels are simultaneously server and client. The demanding control function can be realised using the Saia PG5® software tool.



◀ The Saia PCD® contains the master control and management functions for many distributed systems or large integrated buildings.

### Dimensioning the data storage for S-Web applications

The dimensioning of the data storage must take into consideration the size of the web project and the historical data (trend data) which needs to be stored. The following reference values can be used as guideline to provide a rough estimate.

#### Memory requirement for S-Web pages:

The calculation of the memory requirements for web pages is based on the number of web pages, number of GIF graphics used and the IMaster Java applets. The following reference values can be used as guideline to provide a rough estimate.



S-Web page  
approx. 10 kByte/page

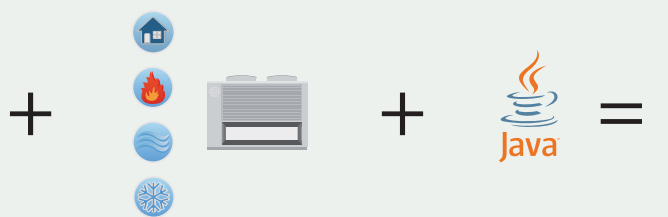

GIF graphics  
1... 10 kByte

Java applet  
approx. 350 kByte

**Memory requirement for web projects**

A project with 30 HMI pages will therefore need approx. the following memory requirement:

$(30 \times 10 \text{ kByte}) + (100 \times 5 \text{ kByte GIF graphics}) + 350 \text{ kByte} = \text{memory requirement for web project approx. 1150 kByte}$

## Memory requirement for trend data

Recorded using CSV files in flash file system

The trend data are stored in groups of max. 10 data points per Saia PG5® Fupla FBox and CSV file.

Header.ref.MemoryM1

HDLLog File 3.0

- En Busy
- Val0 WrOK
- Val1 Error
- Val2 Buffer
- Val3 DelRdy
- Val4 IdxStat
- Val5
- Val6
- Val7
- Val8
- Val9
- Store
- WrFile
- DelFile
- Dir

Dir: ????

>

Time	SmuTime	SmuTime1	CosTime	CosTime1
22.12.2008 14:13:22.438	0.019	0.98	9.9	9999
22.12.2008 14:13:32.001	0.039	39.94	9.2	9210
22.12.2008 14:13:52.001	0.068	58.46	8.2	8253
22.12.2008 14:14:02.000	0.071	71.73	6.9	6967
22.12.2008 14:14:12.002	0.084	84.14	6.4	6403
22.12.2008 14:14:22.001	0.090	93.2	3.6	3623
22.12.2008 14:14:32.011	0.040	36.54	1.6	1699
22.12.2008 14:14:42.000	0.099	99.96	0.2	291
22.12.2008 14:14:52.000	0.085	87.38	-2.2	-2272
22.12.2008 14:15:02.001	0.09	90.92	-4.1	-4161
22.12.2008 14:15:12.001	0.08	80.84	-6.8	-6866
22.12.2008 14:15:22.001	0.067	67.54	-7.3	-7373
22.12.2008 14:15:32.000	0.061	61.66	-8.6	-8668
22.12.2008 14:15:42.000	0.058	58.46	-8.4	-8435

>

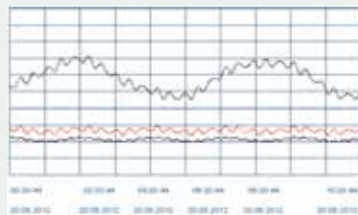

▲ One CSV file is created per FBox with max. 10 data point values per entry. The memory requirement for one entry: approx. 30 Byte (time stamp) + 10 Byte/data point

▲ Trend display in web browser. A max. of 10 trend curves can be displayed per window.

▲ The Saia PG5® Fupla FBox can record and store up to 10 data points

In the following calculation example, 20 data points are recorded for visualisation in trend curves. Ten data points should be recorded for the optimisation phase at intervals of 1 minute and a further 10 data points should be recorded for long-term monitoring at intervals of 15 minutes.

The memory requirement for 10 data points at 1 minute intervals in one day:

$$60 \text{ (mins)} \times 24 \text{ (hours)} \times [30 \text{ Byte (time stamp)} + 10 \text{ (data points)} \times 10 \text{ Byte}] = \mathbf{187.2 \text{ kByte per day}}$$

With this quantity of data it is worth creating a new file every day.

The data should be stored in the controller for a month.

This gives a memory requirement of approx.  $30 \times 187.2 \text{ kByte} = \mathbf{5.616 \text{ MByte per month divided among 30 files.}}$

The memory requirement for 10 data points at 15 minute intervals in one day:

$$4 \text{ (15 mins)} \times 24 \text{ (hours)} \times [30 \text{ Byte (time stamp)} + 10 \text{ (data points)} \times 10 \text{ Byte}] = \mathbf{12.48 \text{ kByte per day}}$$

With this quantity of data, a new file can be created each week  $\rightarrow 7 \times 12.48 = \mathbf{87.36 \text{ kByte per week}}$

The data should be stored in the PCD for a year.

This gives a memory requirement of approx.  $52 \text{ (weeks)} \times 87.36 \text{ kByte} = \mathbf{4.543 \text{ MByte per year divided among 52 files.}}$

### What type of memory modules should be used?

Web pages and log data can be stored in the onboard flash memory and/or the plug-in flash cards.

The web projects and basic data logging with small quantities of data can be stored on the onboard flash memory (depending on the type of CPU) or the plug-in **PCD7.R55xM04** flash memory module. Unlike the onboard memory, flash cards can be exchanged and replaced with new cards. It is therefore easy to archive data or transfer it from one controller to another.

Only the **PCD7.R-SDxxxx** SD flash card module should be used for intensive data logging.

Onboard memory for **6 years** of data monitoring



A Saia PCD3.Mxx60 CPU can record 10 data points for up to 6 years for long-term monitoring in the 128 MByte onboard flash memory. The programmable PCD7.D4xxxT5F SBC micro-browser panel and the PCD1.M2160 both also have a large onboard flash memory and are ideal for monitoring tasks. The plug-in PCD7.R-SDxxxx SD flash card with a memory capacity of up to 1 GByte lasts even longer and can store data for decades in a Saia PCD® controller.

### Important information for using the flash memory module

A memory module supports max. 900 files.

S-Web uses up to 70% of the nominal physical memory.

The size of a single file should not exceed 1 MByte. This guarantees that all the files can be sent via the Saia PCD® as email attachments.

The calculation examples are reference values without BACnet or Lon communication.



PCD7.R-SDxxxx



PCD7.R55xM04

### Internet access without public IP addresses and shortening the load times

The S-Web concept with the SBC Web Connect software (part of the Saia PG5® Controls Suite) enables access to all web servers, even without public IP addresses. This is achieved by installing the SBC Web Connect software on a local frontend PC. In this case, the frontend PC simply requires a registered IP address. This provides all browser PCs (without additional software) on the Intranet and Internet access to the web servers in all PCD devices, and thanks to the gateway function, this is also possible over several network layers. This makes the SBC Web Connect software fully transparent for the user. The connection is established in the browser as usual by entering the URL (e.g. [www.frontend.com/PCD-controller/web-page.html](http://www.frontend.com/PCD-controller/web-page.html)). Large files such as images or summary pages can also be stored on the frontend PC to relieve the memory in the PCD controller and optimise the download times. If necessary, OPC servers or a SCADA system can also be operated on the frontend PC in addition to the web application.

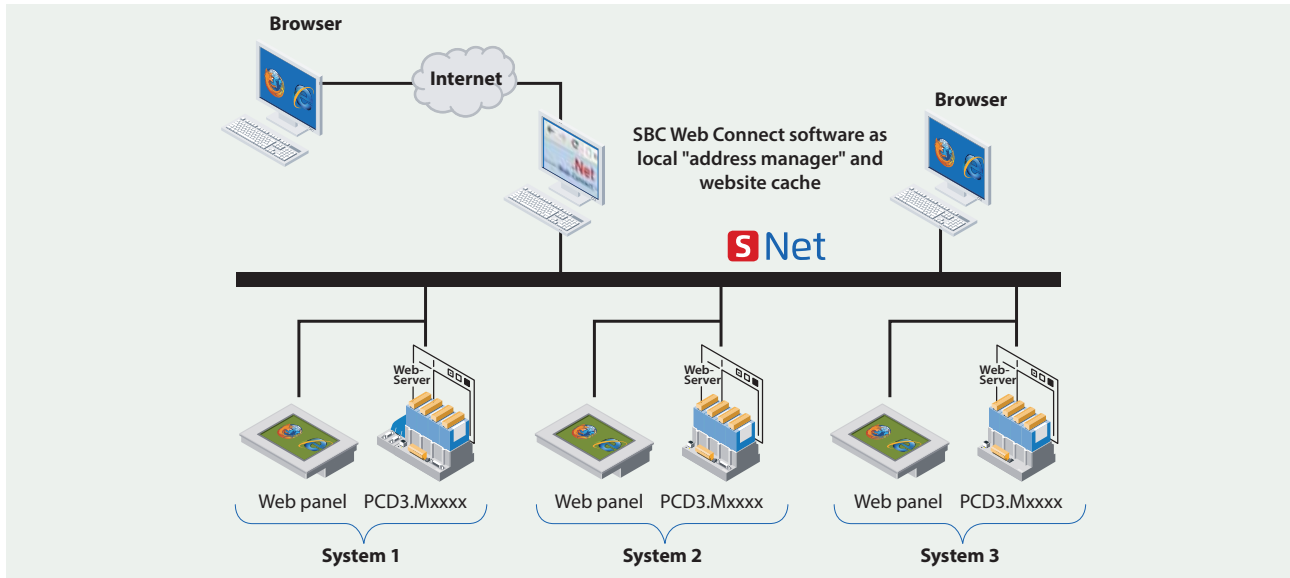

▲ SBC Web Connect can also be used to access the PCD-Web-Server in the local network even without public IP addresses. The user interface is always the same whether it is operated locally or remotely.

### Local or "remote" operation

The same user interface with the same current data from the decentralised PCD-Web-Servers is always available everywhere. The decentralisation of the data and functions considerably reduces the cost of developing the application, administration and support.

### The S-Web operation and monitoring interface does not depend on part of the ICA application

The Saia PG5® Web Editor and the Saia PG5® are two independent, autonomous applications. However, Saia PG5® Web Editor 8 can directly access the Saia PG5® defined symbols/names in the background. Symbols/names which are only used locally can also be defined in the Web Editor application.

The ICA application created in the Saia PG5® does not have to be modified or recreated if the visualisation application is modified. The Web Editor automatically links the defined symbols to the physical addresses used on the automation device.

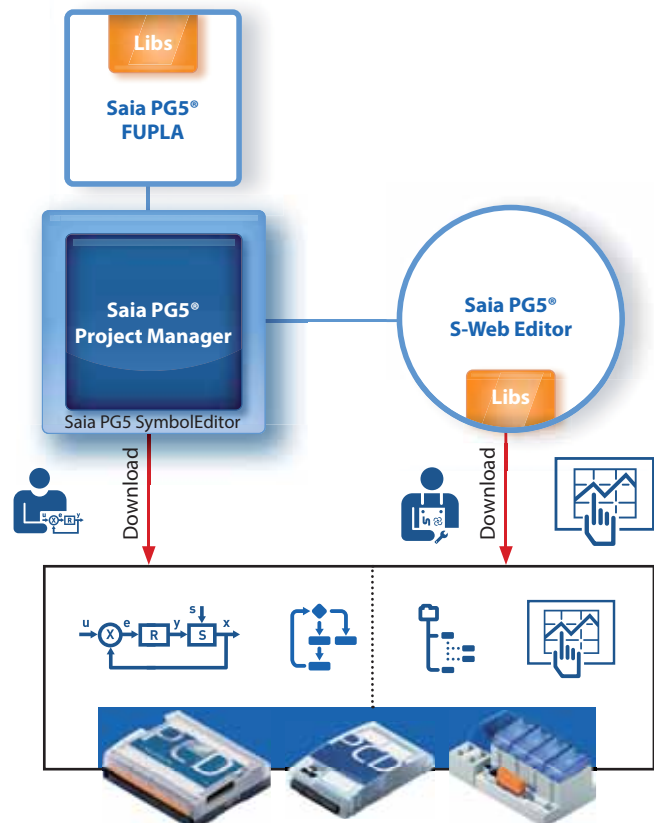

▲ ICA and web HMI applications can be loaded independently of one another into the PCD controller



If the ICA application is modified so that the physical addresses change (which is the case if Clean All Files is activated, for example), the web application does not have to be adjusted. However, a download is required to link the new symbolic addresses.

### 3.5 Tender information

#### What is the difference with S-Web?

The on-site technology is mainly determined by the planning and tender specification processes. In single incremental developments, it is enough to continue maintaining existing planning and design specification standards. However, if the technological development results in large structural changes, the planning process also requires large changes which can then affect the resulting tender specification. This chapter is a guide for planners who want to further develop their tender specification standard in this sense.

#### Technical basis of the "old" automation pyramid

- ▶ Replacement of the analog control technology
- ▶ Master ↔ Slave
- ▶ MHz/MByte PC technology
- ▶ Proprietary/closed technology

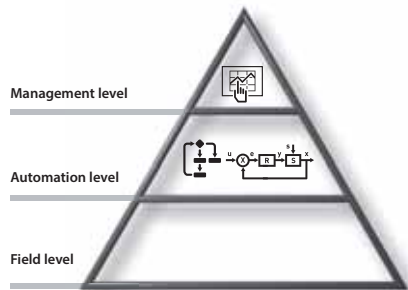

#### Functional structure of "old" automation pyramids

Automated system's core function distributed across various levels and different devices → Proprietary number of different buses, gateways and expensive integration. "Total integration" is propagated as an "emergency" solution by large manufacturers.



#### Technical basis of "lean" automation pyramids:

- ▶ Replacement of dedicated control/management PCs
- ▶ Client ↔ Server/local remote
- ▶ GHz/Gigabyte technology in automation device
- ▶ Web+IT technology/open for all

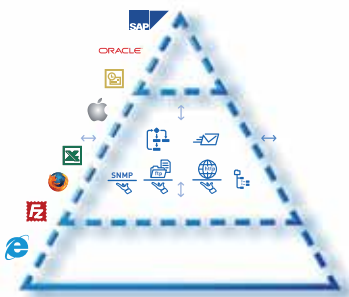

#### Total integrated system pyramid

Everything from a single source. Single operator. Opposite of lean.



#### Functional structure of "lean" automation pyramids

All core functions of the automated system possible in one device. Interaction of all devices via Web+IT standards. Integration from field to control layer provided via LAN/WAN.

SBC S-Web is an innovative system comprising a combination of technical innovations and non-proprietary, globally recognised technologies. It has therefore been steadily developing for more than 10 years. SBC S-Web is causing a paradigm change in automation technology in terms of operation, monitoring and management. It makes the boundaries of the classic automation pyramids transparent and integrated, both internally and externally.

#### Structure of lean automation systems

All the measurement/control devices of this structure have the same functional structure and capabilities = PLC + Web + IT. Each automation device can have relationships in the client and the server to every other automation device and residual web/IT technology in the property. This makes it possible to maximise use, reduce operational expenses and create a highly flexible life-cycle. But what does this mean for the tender specifications?

- ▶ Lean automation system: all core functions of the automation (PLC+Web+IT) integrated in that automation device enable the integration and interaction of all devices from the field level to the control level.

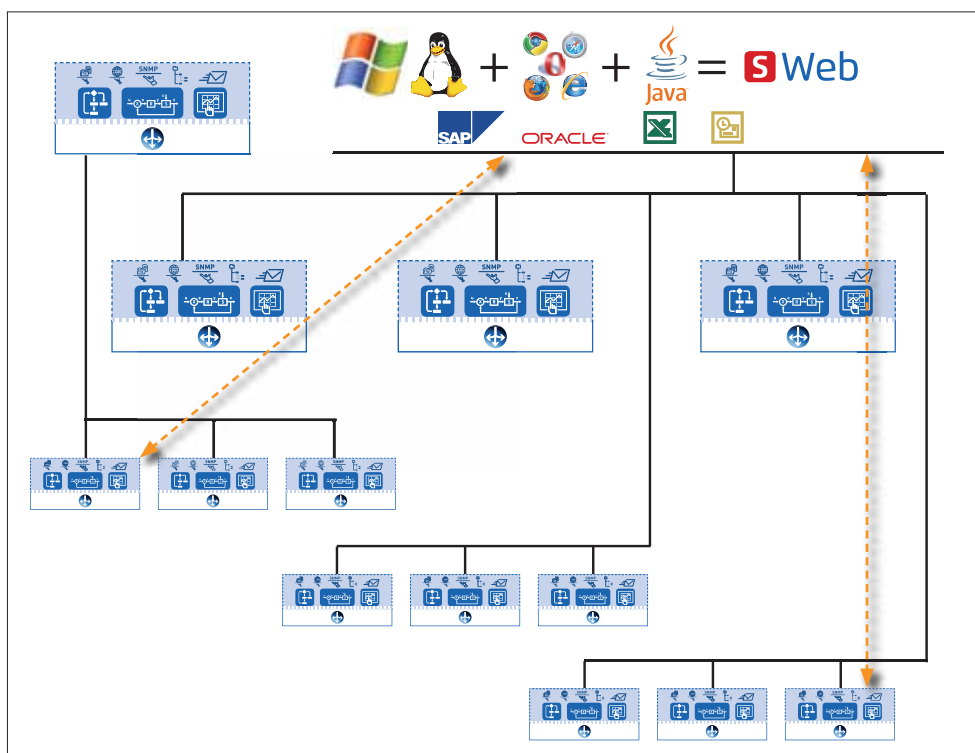



## What difference does S-Web make to lean automation tender specifications?

<b>01.01 LOT: Ludwig-Erhard Street 22.....</b>	<b>17</b>
<b>01.01.01 Network and Building Management system.....</b>	<b>17</b>
01.01.01.01 Network system.....	17
01.01.01.02 Server system.....	18
01.01.01.03 Building Management system .....	19
<b>01.01.02 HVAC system automation.....</b>	<b>43</b>
01.01.02.01 Hardware.....	43
01.01.02.02 Renovation work.....	48
01.01.02.03 Cables / Installation / Removal.....	48
01.01.02.04 Services.....	48
<b>01.01.03 Room automation.....</b>	<b>50</b>
01.01.03.01 Hardware.....	53

▲ Extract: Structure of a classic tender specification

### 1. Should the PC be included in the automation pyramid?

A dedicated designed control PC (Windows PC) and control/management software is no longer needed for recording and for regular operation of the ICA technology of a property/site. Every device and system already has its own integrated control/management function.

### 2. Local versus central – bottom-up versus top-down

In the individual systems, the control/management function is already designed as part of the “automation levels”. This is realised in the form of SCADA web pages which are loaded via the automation devices’ web servers and displayed in the browser. A system and all connected devices/ sub-sections can be maintained, optimised and monitored in this way. The historical operating data and alarms are stored locally in the automation devices.

Analogy: As with SBC S-Web, with BACnet the “SCADA” function is integrated as an object in the BACnet automation device!

### 3. The end of extremism:

#### Text displays in the field - 21” system images in the control centre

A single text display on the system does not provide the operators needs. A large screen in the remote control centre is also of little help: its complexity is also slightly daunting for non-specialists. S-Web brings usable, practical system conditions “on site” and everywhere where a network connection is available. Depending on the complexity of the application, a 5-10” touch panel with web browser is designed for the system control cabinet. A text display is not suitable for the web technology. The local browser panel works only as a client and loads its applications from the control devices (server) as required. Every browser device connected to the LAN/WLAN (PC/mobile device) also has access to the plant operating/monitoring.

15,00 pcs System services SDI V-GLT  
Visualisation of the process data with the following program points:

- full graphical, object oriented plant images (including scanned photos) with dynamic fade-in, change of color and animation
- resp. creation of html pages for web based visualisation
- Operation out of the plant image
- Graphical, user defined selection menus
- Installation and activation of the visualisation

▲ Example of a real design specification for lean automation: Each system already has a SCADA function embedded.

S-Web requires fewer fixed on-site panels than classic technology.

This reduces costs and saves space.



OZ	Quantity	Unit	unit price EUR	total amount EUR
*** required position without total amount				
03.02.0020		software for operator device		
as OZ (Pos.-Nb. 10))				
however, as a cabinet operator panel without graphical images and without storing the data to the harddisk				

◀ This separate item is no longer needed with SBC S-Web. Browser touch panels do not need any dedicated software.



#### 4. Quo Vadis: PC-based control/management software?

With S-Web, the entire automated system/ICA operation of a property is ensured without PC/Windows applications. However, classic PC applications are still useful and necessary in many cases. Trough the autonomy of the automation level enables these PC applications to be less closely coupled to the automation pyramid and therefore more “replaceable”. Using S-Web reduces the service expense associated with integrating PC applications. It is only necessary to realise the truly over-arching, global process views. The system- and object-specific views are already realised by S-Web and can be requested via a browser.



The PC application undertakes the useful task of automatically capturing the decentrally distributed operating data/ applications of a property. If the decentralised data files are not deleted, the reliability has a heterogeneous data redundancy.

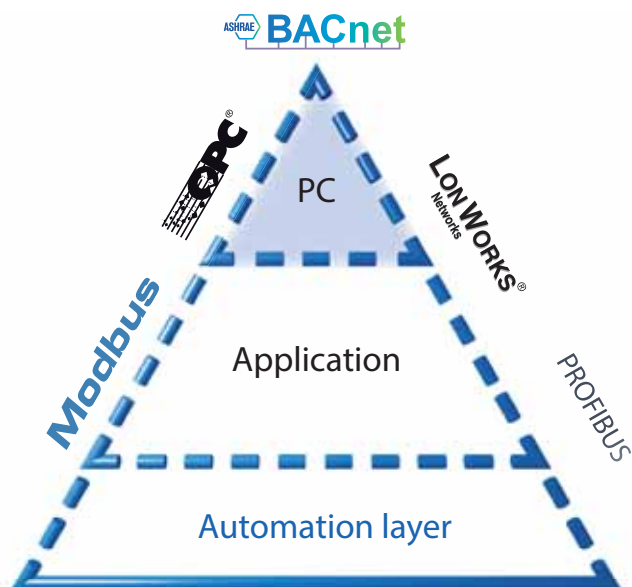

◀ Classic PC-based control and management systems can be easily combined with S-Web. Existing control/management/SCADA software can be used in parallel with S-Web by using tried and tested mechanisms (e.g. OPC, BACnet). SBC S-Web also allows access to data directly via the web server CGI-Calls; without any middleware such as OPC (for more information on this, see page 240 “Web server standard CGI interface”)

#### Saia Visi.Plus: The PC-based management/SCADA software with ideal fit for SBC S-Web.

The Saia Visi.Plus objects/templates are visually/graphically identical to those of SBC S-Web. This means it has the same look and feel whether it is a Windows or a browser application. This makes the boundaries seamless. In practice, SBC S-Web and Saia Visi.Plus are often used in parallel. This is particularly the case when optimising the operation of many systems and large properties. For such tasks, Saia Visi.Plus can be used without license fees. (For further detail please see chapter B1.2 “Application software for Windows PCs”)



◀ Saia Visi.Plus: Ideal with integrated Saia PCD® and S-Web.

### The results of classic tenders:

This technology is installed in properties and then has to be maintained and extended over the following 15-20 year life-cycle!

Superior standard systems and operating stations have access to the system data via special drivers and middleware.

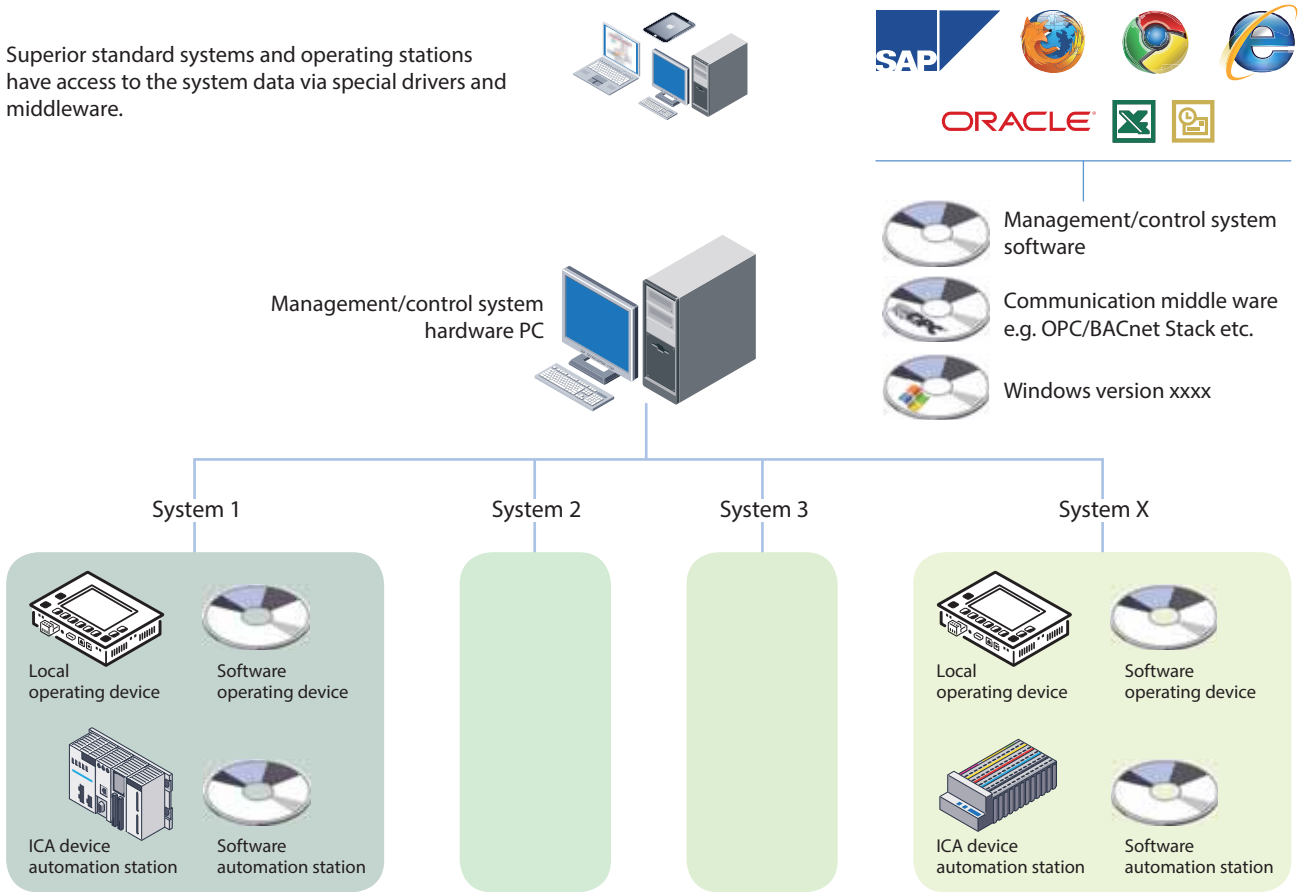

▲ Classical structure with complex hierarchies → consuming installation, inflexible and expensive in maintenance and care.

### The results of lean automation system design specifications with S-Web:

The control/management function is realised where it is needed. The automated system uses as little additional software/hardware as possible. Direct coupling of all devices via Web+IT standards – without middleware/special products.

Superior standard systems and operating stations have direct access to the system data any time, anywhere.

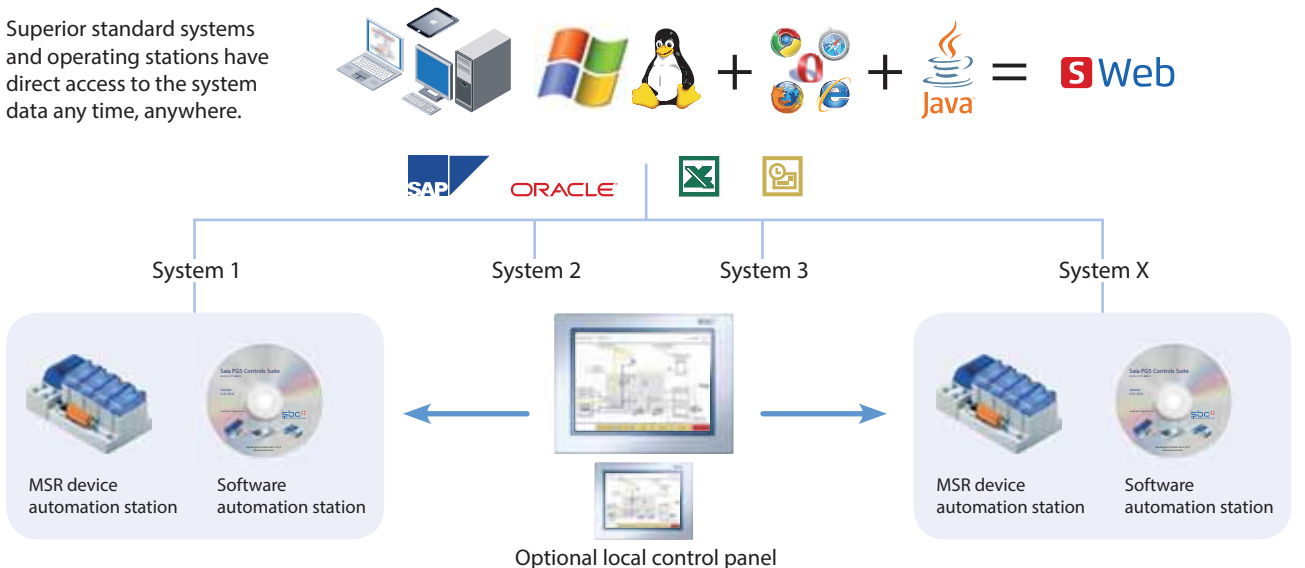

▲ Lean automation with slim-line structures:

Web/IT interfaces and SCADA functions integrated in the ICA device → high degree of flexibility and easy to maintain/expand.

### 3.6 Products/tools

#### PC Software

**Saia PG5® Web Editor**  
Efficient engineering of graphical interactive interfaces



**SBC.Net**  
Gateway and proxyserver functions

Detailed information in Chapter B1 Software

#### SBC Micro Browser

Dedicated web browser for automated systems with SBC S-Web. Integrated in Saia PCD® Web Panel MB



**SBC Micro Browser Apps** for "third party hardware"

- ▶ Apple App
- ▶ Android App



Detailed information in Chapter A2 Operation and Monitoring

#### S-Web accessories

Memory for the automation station to store historical data.



**Base module for the SD Flash memory**

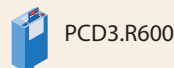

PCD3.R600



PCD2.R6000

#### SD-Flash memory

512 MByte  
PCD7.R-SD512



1024 MByte  
PCD7.R-SD1024



Memory module  
PCD7.R5xx

Detailed information in Chapter A1.1 Saia PCD® system description

#### Industrial web panel with Windows operating system

Immediately operational without software installation



- ▶ Specially designed for use with SBC S-Web technology for automated systems.
- ▶ SBC.Net is pre-installed
- ▶ Ideal for linking Windows applications or proprietary Microsoft .Net applications to the automation world.



Detailed information can be found in chapter A2 "Operation and monitoring".

#### Using a SBC S-Web system with devices belonging to the existing infrastructure

Each PC can be used to visualise the Saia PG5® Web HMI pages. The web HMI pages created using the Web Editor are interpreted by a Java applet in the browser on the PC.

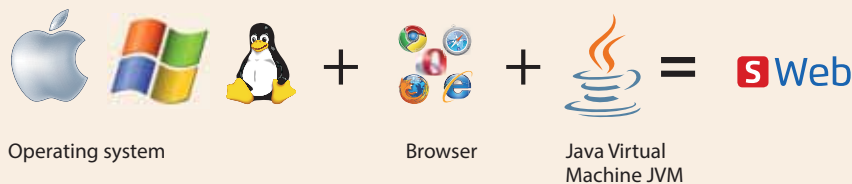

Office PC with browser and Java on board

Any device made available by an operating system with the support of a browser and Java engine can be used with SBC S-Web.

## S-Web pages and S-Web projects are created using Saia PG5® Web Editor

The Saia PG5® Web Editor is designed with simplicity and efficiency in mind. Suitable thanks to web technology. The Web Editor also places no limitation on the number of pages and allows maximum freedom in terms of function and design. If that is what you want and need. A large standard library with graphical objects and templates is provided for normal users.

In Web Editor you are not tied to a fixed grid and are completely free in terms of the design and structure of the Web-HMI pages. Visualisation elements can be arranged freely. System images can aid the user during operation. The entire application can be split into smaller sectional views across several pages.



▲ Projects created using the Web Editor can be used across various devices.



▲ No specifications for the placement of visible elements. Free graphical design possible.

### Create once, use on many devices

An S-Web project which has been created using the Saia PG5® Web Editor can be used simultaneously by various browser devices.

The appearance of the page and the operating philosophy do not change.

The S-Web application is executed using a standard web browser and Java applet. With Saia PCD® Web Panel the application runs in the SBC Micro Browser which has been specially developed for ICA technology/automation.

## Realising management and optimisation functions

The trending and alarming functions are stored as templates in the libraries of the Web Editor and can be used directly in this form.

Various templates are available for displaying trend curves. All the media in the automation device can be historically recorded and visualised in an online trend curve. The alarming function records and stores alarms and events and visualises current and historical alarms with different template objects.

The templates consist of a collection of standard elements. They can be adjusted at any time as required to the application conditions using Saia PG5® Web Editor. Or they can be used as a basis for creating your own collection of templates.



▲ Trending template adjusted to meet the specific needs of the customer



▲ Historical trending with the default template



▲ Alarming with the default template

### Using Saia PG5® HeaVAC Lib- and Saia PG5® DDC Suite templates

The Saia PG5® HeaVAC- and Saia PG5® DDC Suite library provide the user with a collection of pre-assembled function and system objects with graphical templates. They are designed for primary HeaVAC technologies and general building automation systems. The templates can be transferred unaltered and also adjusted to meet the conditions of the application if necessary. A detailed description of the libraries can be found in Chapter B1 Software.

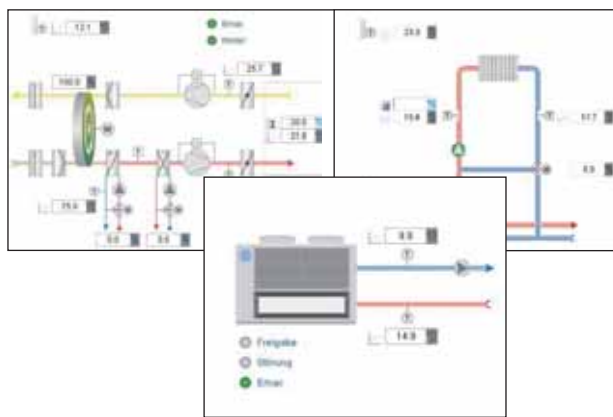
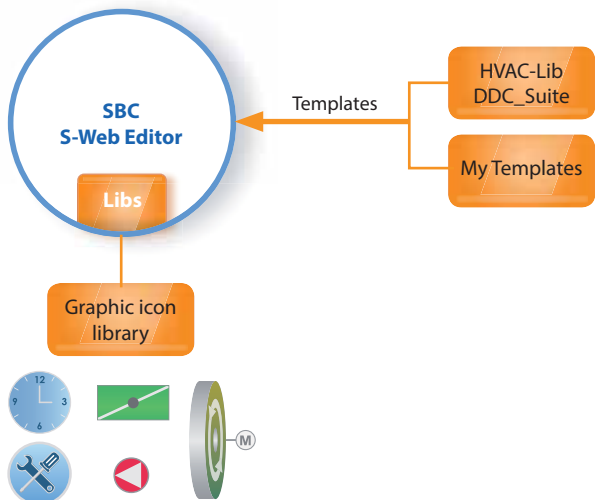

▲ Web Editor contains comprehensive template and graphics libraries for the programmer for efficient engineering. It is also possible to create your own templates.

### Little time required to create a successful result

Saia PG5® Web Editor makes it possible to achieve a “basic fit” quickly and efficiently. This means that the basic necessary functions for acceptance are realised.

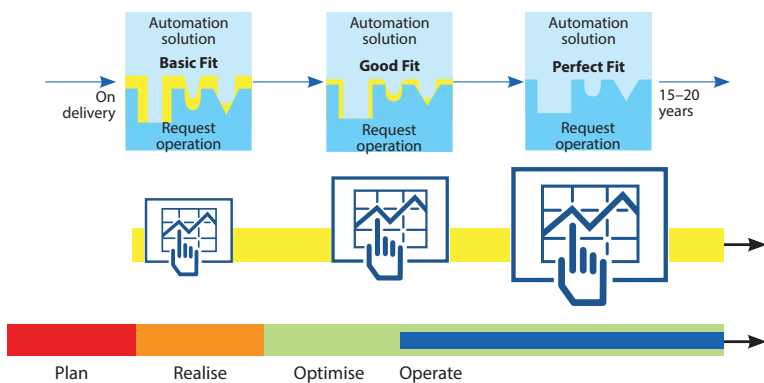

The SBC S-Web application can be adjusted at any time during the initial optimisation phase of the system and later during continuous operation to meet the actual, individual requirements. The way to good fit and perfect is always open, nothing is installed and nothing is closed off.

▲ The maximum degree of engineering freedom is given over the entire life-cycle for optimisation and adjustment; for operator, installer and service provider.

### Adjusting S-Web projects following acceptance

The S-Web applications of a Saia PCD® automation station can be adjusted and expanded completely independently of the local regulation/logic project. The core ICA functions are realised using the Saia PG5 software tool and loaded into the Saia PCD®. The Saia PG5® Web Editor can also be used to load new S-Web applications into the Saia PCD®. It is also possible for several S-Web projects to work on one and the same automation device in parallel. This makes it possible to create sub-projects for specific user groups (e.g. for service or operators). It is thus possible to influence the diversity of the browser devices being used.

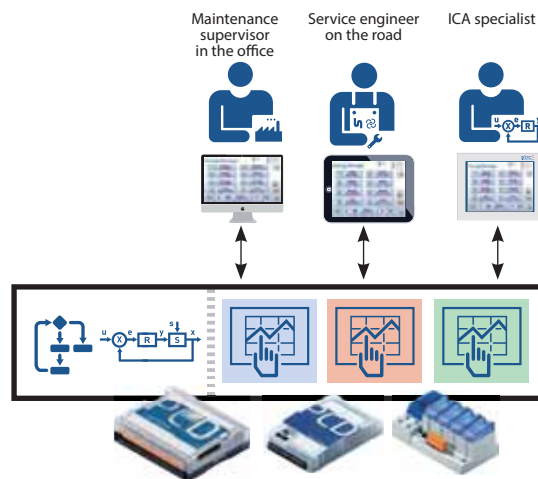

▲ Several HMI applications adjusted/optimised to the respective user groups are possible on one controller.



**Standard PCD-Web-Server CGI interface**

The COSinus integrated HTTP web server has a standardised Common Gateway Interface (CGI). The CGI interface supports the direct access (reading and writing) to all PCD media (register, flags, DB/texts, I/Os, etc.) and the file system (up/download, delete, etc.)

A client (browser, Java or MS.Net application) can then access the data on a PCD controller by entering the URL and corresponding CGI command directly (without using specific drivers).

Java, .Net Application

```

public void getFileStream(String URI, String Folder, String FileName)
{
    // INIT SubClasses
    MyWebRequest myWebRequest;
    MyWebResponse myWebResponse;

    MyWebRequest = MyWebRequest.Create(URI);
    MyWebResponse = MyWebRequest.GetResponse();

    Stream stream = MyWebResponse.GetResponseStream();
    ...
}
    
```

URL command in web browser



SBC Micro Browser



The Saia PCD® Web-Server processes requests/orders via the CGI interface and sends the client the requested information.



Microsoft.Net or Java already have the categories "WebRequest" and "WebResponse" available for requests made to a web server.

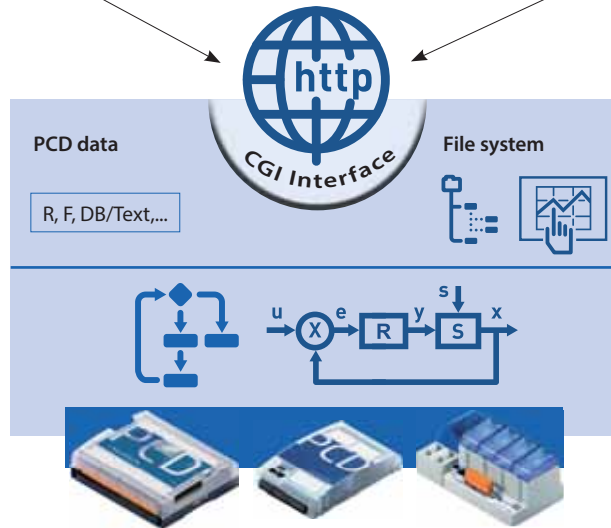

▲ The Saia PCD® Web-Server provides an open CGI interface in addition to the HTTP server.



**SBC.Net Suite**

The SBC.Net Suite includes components and class libraries for communicating via S-Bus (master and slave) or the CGI interface. It allows the basic integration of Saia PCD® data in a Windows application without having to worry about communication drivers (middleware) or CGI syntax. Further information can be found in Chapter B1 Software.

**Accessing the Saia PCD® Web-Server with MS Office applications**

Microsoft Office products support the integration of external web sources. This makes it very easy to visualise the data of a Saia PCD® controller in an MS Office application. The MS Office products can also access via the CGI interface of a Saia PCD® Web-Server to read or write data using the VBA programming language.

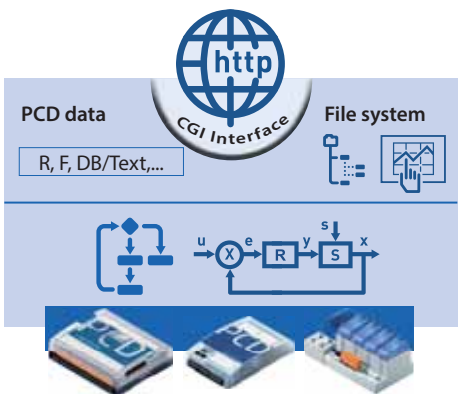
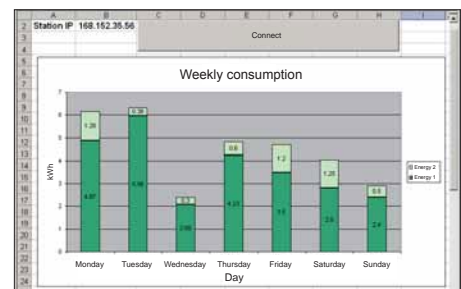

Saia PCD® data can be linked to a cell using Microsoft Excel. The data in the linked Saia PCD® will be permanently updated for as long as the Excel application is running. All this occurs without any of the specific driver software/ middleware required by other systems.



### 3.7 Using an Automation Server as a technical basis for S-Web

An Automation Server is part of the COSinus operating system and is therefore integrated in all Saia PCD® controllers. It comprises common web/IT technologies and guarantees the exchange of data between the operator/user and automation without any proprietary hardware or software. Specially adjusted automation functions and objects form the relevant counter piece in the controller application. The IT/web functions are therefore seamlessly integrated in the automation device in the best way possible and can be used efficiently.

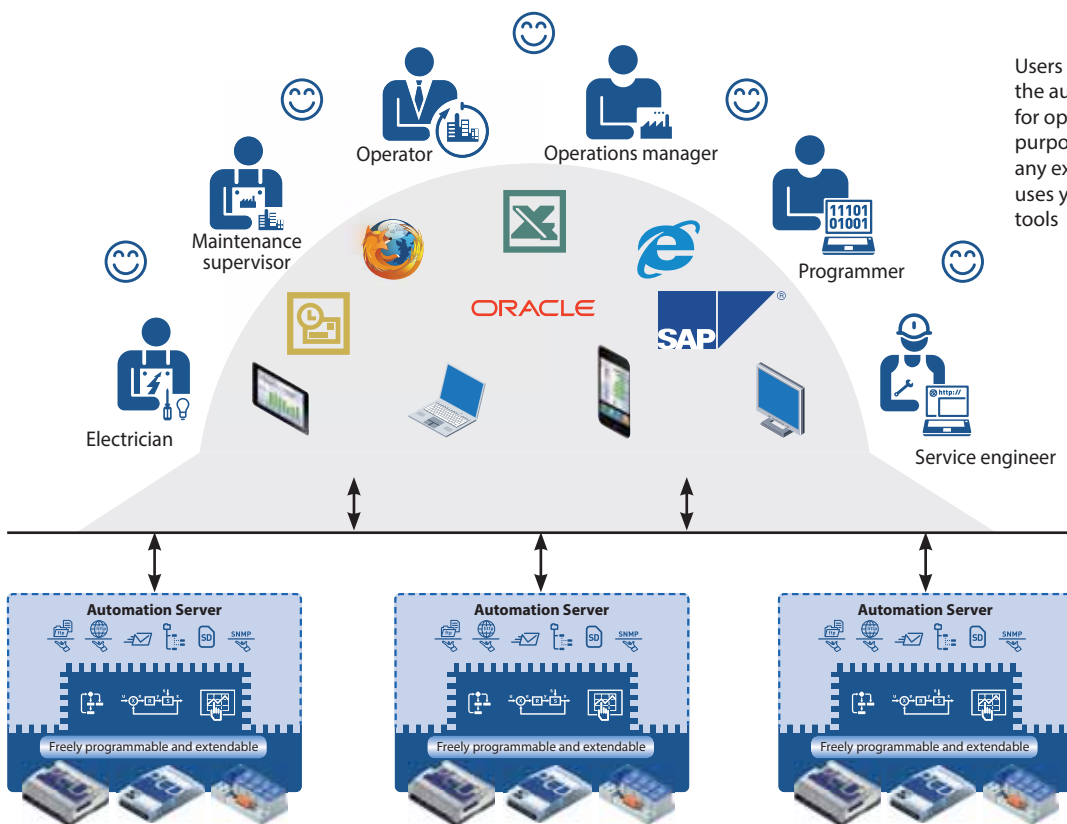

Users are able to access the automation device directly for operation and maintenance purposes. There is no need for any extra software as it simply uses your standard software tools

Ideally, every automation device will have an Automation Server: each device can be accessed equally and complex communication hierarchies are unnecessary.

#### Automation Server components



**Web server**

The system and process are visualised in the form of web pages and can be requested from the web server using browsers such as Internet Explorer, Firefox, etc.



**FTP server**

Files can be loaded onto or read from the automation device via the network using standard FTP clients (e.g. Filezilla).



**File system**

Process data, records, etc. are stored in easy-to-access files. Standard formats make it easy to process them further, e.g. with Microsoft Excel



**E-mail**

Critical system statuses, alarms and log data can be sent by email.



**Flash memory**

Their large storage capacity means Saia PCD® controllers do not rely on a master PC system, even over a long time period. The data storage capacity of the Saia PCD® controller can be expanded to up to 4 GByte by installing a SD flash card.



**SNMP**

**SNMP agent**

Messages and alarms are transmitted according to IT standards. Access to automation data with IT management system.

**SNTP, DHCP, DNS, etc.**

Other standard protocols for simple integration in existing IT infrastructures



# C

## Annex

<b>C1</b>	Planning Guide	243
<b>C2</b>	Status: Product launch and availability	249
<b>C3</b>	Type Index	251





## 2. Definition of device family

Saia PCD® devices as user programmable instrumentation, control and automation (ICA) equipment with a design that is either flat, compact or cassette-type. Modular and expandable device series with enough reserves to allow expansion of communications for the device family.

### Specification

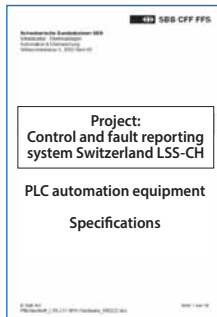

### Requirement from specification

**Description:** Two stage partial air conditioning system with plate heat exchanger, air heater and air cooler. Ventilation with manual/emergency operation. A control cabinet is to be provided for the installation of electrical and automation technology.

**Controller:** Flexible, modular and expandable controller

**Interfaces:** Basic interfaces – Ethernet / USB energy measurement M-Bus; expandability option

**Expansion reserve:** At least 20 % expansion reserve

**Data:** Recording/storage of operational data

### Selection criteria

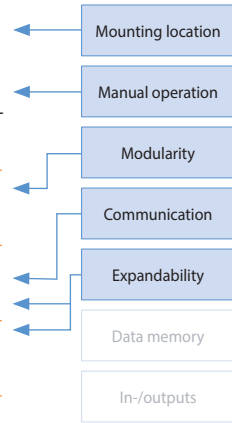

Index	Reading active	Emergency stop	Control functions
1	1	1	1
2	1	1	1
3	1	1	1
4	1	1	1
5	1	1	1
6	1	1	1
7	1	1	1
8	1	1	1
9	1	1	1
10	1	1	1
11	1	1	1
12	1	1	1
13	1	1	1
14	1	1	1
15	1	1	1
16	1	1	1
17	1	1	1
18	1	1	1
19	1	1	1
20	1	1	1
21	1	1	1
22	1	1	1
23	1	1	1
24	1	1	1
25	1	1	1
26	1	1	1
27	1	1	1
28	1	1	1
29	1	1	1
30	1	1	1
31	1	1	1
32	1	1	1
33	1	1	1
34	1	1	1
35	1	1	1
36	1	1	1
37	1	1	1
38	1	1	1
39	1	1	1
40	1	1	1
41	1	1	1
42	1	1	1
43	1	1	1
44	1	1	1
45	1	1	1
46	1	1	1
47	1	1	1
48	1	1	1
49	1	1	1
50	1	1	1

**Maximum PLC flexibility**  
Sustainable automation solutions require maximum flexibility in expansion and function. The greater the need for flexibility and expandability, the more weight should be placed on open, modular systems. The basic "USB / Ethernet" communication interfaces for programming and data exchange are the basis for sustained system usability.

**Mounting in control cabinet**  
Modular systems are generally used when mounting is required inside closed electrical control cabinets. The «Flat» or «Cassette» system forms do not differ in function, but may affect space availability in the cabinet.

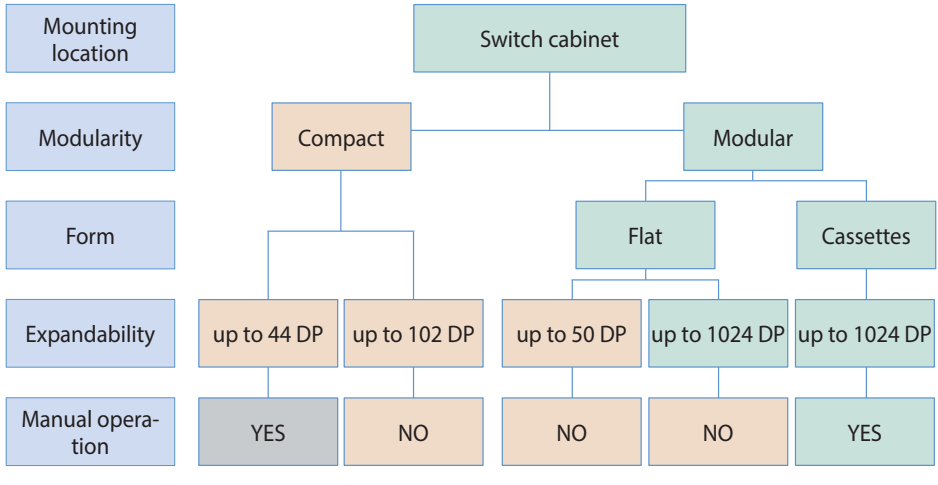

**System selection**  
Device families PCD1 / PCD2 and PCD3 meet the specification requirements regarding basic communications interfaces. Device families PCD2 and PCD3 meet the requirements for modularity and expandability. Based on its direct manual/emergency operation capability, the PCD3 family is chosen. For further selection criteria, see steps 3 and 4.

System families	COMPACT		MODULAR		
	PCS1	PCD3 Compact	PCD1	PCD2	PCD3
Ethernet/USB					
Modularity		(-)			
Expandability					
Manual operation					
	Meets requirement only in manual/emergency operation	Similar to the PCD3 family with reduced expandability. Without manual/emergency operation	Meets requirement of basic interfaces with reduced expandability. Without manual/emergency operation	Meets requirement of basic interfaces and expandability. Without manual/emergency operation	Meets requirements of basic communications, expandability and manual/emergency operation





### 4. Definition of in-/outputs

Various plug-in I/O modules allow the modular systems to be expanded and adapted as required. The system can therefore be adjusted or added to at any time.

#### Specification

### Sample Project

Project:  
Control and fault reporting system Switzerland LSS-CH

PLC automation equipment  
Specifications

#### Requirement from specification

**In-/outputs:** Connections: spring terminals (0.5–1.5 mm<sup>2</sup>, rigid or flexible conductor); terminals pluggable. Module replacement should be possible without any additional tool.

#### Selection criteria

- Mounting location
- Manual operation
- Modularity
- Communication
- Expandability
- Data memory
- In-/outputs

Physical I/O functions									
		Outputs				Inputs			
		BO	BC	BI	AI				
0	1								
1	2								
2	3								
3	4								
4	5								
5	6								
6	7								
7	8								
8	9								
9	0								
0	1								
1	2								
2	3								
3	4								
4	5								
5	6								
6	7								
7	8								
8	9								
9	0								
0	1								
1	2								
2	3								
3	4								
4	5								
5	6								
6	7								
7	8								
8	9								
9	0								
0	1								
1	2								
2	3								
3	4								
4	5								
5	6								
6	7								
7	8								
8	9								
9	0								
0	1								
1	2								
2	3								
3	4								
4	5								
5	6								
6	7								
7	8								
8	9								
9	0								
0	1								
1	2								
2	3								
3	4								
4	5								
5	6								
6	7								
7	8								
8	9								
9	0								
0	1								
1	2								
2	3								
3	4								
4	5								
5	6								
6	7								
7	8								
8	9								
9	0								
0	1								
1	2								
2	3								
3	4								
4	5								
5	6								
6	7								
7	8								
8	9								
9	0								
0	1								
1	2								
2	3								
3	4								
4	5								
5	6								
6	7								
7	8								
8	9								
9	0								
0	1								
1	2								
2	3								
3	4								
4	5								
5	6								
6	7								
7	8								
8	9								
9	0								
0	1								
1	2								
2	3								
3	4								
4	5								
5	6								
6	7								
7	8								
8	9								
9	0								
0	1								
1	2								
2	3								
3	4								
4	5								
5	6								
6	7								
7	8								
8	9								
9	0								
0	1								
1	2								
2	3								
3	4								
4	5								
5	6								
6	7								
7	8								
8	9								
9	0								
0	1								
1	2								
2	3								
3	4								
4	5								
5	6								
6	7								
7	8								
8	9								
9	0								
0	1								
1	2								
2	3								
3	4								
4	5								
5	6								
6	7								
7	8								
8	9								
9	0								
0	1								
1	2								
2	3								
3	4								
4	5								
5	6								
6	7								
7	8								
8	9								
9	0								
0	1								
1	2								
2	3								
3	4								
4	5								
5	6								
6	7								
7	8								
8	9								
9	0								
0	1								
1	2								
2	3								
3	4								
4	5								
5	6								
6	7								
7	8								
8	9								
9	0								
0	1								
1	2								
2	3								
3	4								
4	5								
5	6								
6	7								
7	8								
8	9								
9	0								
0	1								
1	2								
2	3								
3	4								
4	5								
5	6								
6	7								
7	8								
8	9								
9	0								
0	1								
1	2								
2	3								
3	4								
4	5								
5	6								
6	7								
7	8								
8	9								
9	0								
0	1								
1	2								
2	3								
3	4								
4	5								
5	6								
6	7								
7	8								
8	9								

### 5. Device composition



Switch cabinet automation

	COMPACT		COMPACT		
	PCS1	PCD3 Compact	PCD1	PCD2	PCD3

#### Definition of device family

DEVICE FAMILY	Ethernet/USB		•	•	•	•
	Modularity		(-)	•	•	•
	Expandability			•	•	•
	Manual operation	•				•

#### Definition of communication

COMMUNICATION	Ethernet port (switch)		1	2	2	2
	Interfaces	4	4	8	15	13
	M-Bus	External	External	Internal	Internal	Internal
	Data memory/ file system		•	•	•	•

#### Definition of in-/outputs

<b>PCD3.E165</b> Binary input module with 16 inputs 24 VDC / feedback LED	<b>PCD3.W340</b> Analogue input module with 8 inputs; universally selectable Active/passive	<b>PCD3.W800</b> Analogue output module with 4 outputs 0...10VDC; 3x manual operation	<b>PCD3.A810</b> Binary output module 230VAC with 4 relays; output contacts manually operable	<b>PCD3.A400</b> Binary output module 24 VDC with 8 transistor output contacts	<b>PCD3.C100</b> Expansion housing 4 slots with PCD3.K010
--	--	--	--	---	--

#### System and device composition: Saia PCD3

		Total
▶ PCD3.M5540	CPU for user program	1
▶ PCD3.E165	Input module, digital	2
▶ PCD3.A810	Output module, digital 230VAC	1
▶ PCD3.A400	Output module, digital 24VDC	1
▶ PCD3.W340	Input module, analogue	1
▶ PCD3.W800	Output module, analogue	1
▶ PCD3.C100	Expansion housing	1
▶ PCD3.K010	Connection plug	1
▶ PCD7.R551M04	Flash data memory module	1

**i** The selected PLC - PCD3.M5540 - meets all requirements of the specification and data point list. Other CPU types from the PCD3 family are also possible.

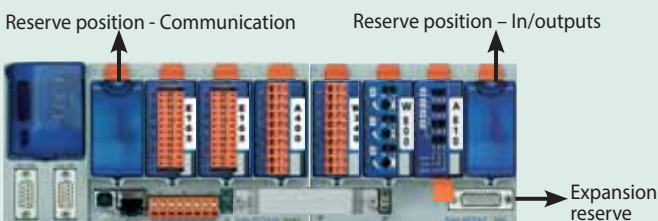

#### Saia PCD® function matrix

Product family	Saia PCD3	Saia PCD2	Saia PCD1	Saia PCD3 comp.	PCS1
Function					
High expandability (> 500DP)	•	•			
Ethernet interface	•	•	•	•	
USB programming interface	•	•	•	•	
PS232 programming port (PGU)	•	•			•
Maximum number of interfaces	13	15	8	4	4
BACnet on IP	•	•	•		
BACnet MS / TP	•	•	•		
LON on IP	•	•	•	•	
LON FTT 10	•	•	•		•
FTP	•	•	•	•	
http direct	•	•	•	•	
Web server	•	•	•	•	•
Data memory - file system	•	•	•	•	
Battery	•	•	•	•	
Manual/emergency operation	•				•
Integral display		•			•
Functional expandability	•	•	(•)	(•)	(•)
Freely programmable	•	•	•	•	•
Modular	•	•	•		
Software - platform compatible	•	•	•	•	•



## Status: Product launch and availability

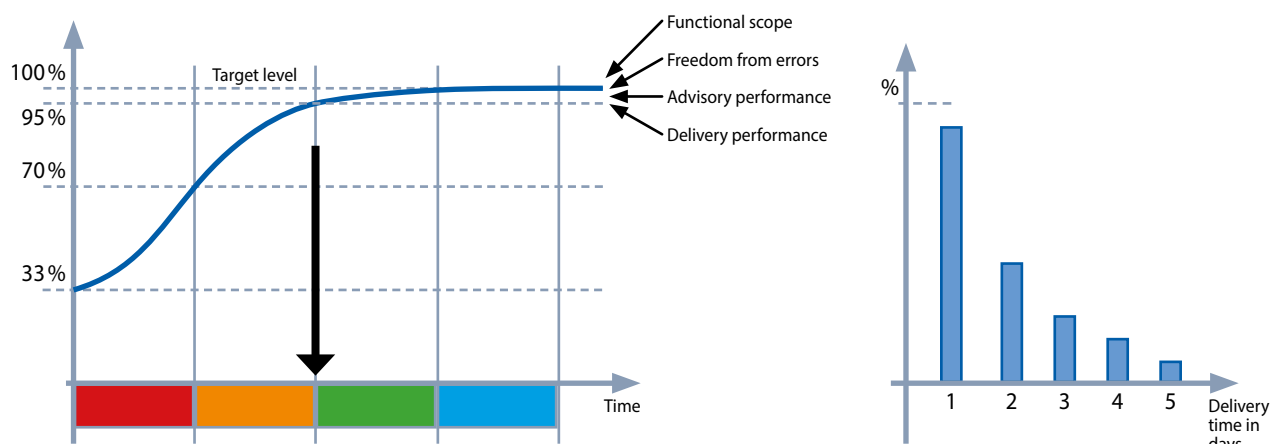

Natural learning curve when introducing products into manufacturing, logistics, support, documentation and function

### Target delivery performance

- 80 % of deliveries in 2 working days
- 95 % of deliveries in < 1 week
- On-time delivery > 98.5 %

### Release status of products

Product maturation is an evolutionary process and follows a maturation and learning curve. It starts with a product idea, which many people and divisions within the company then work on for a long time to reach all the new product's various targets. These targets represent the function and design of the product. The manufacturer's performance and quality standards must also be achieved.

At Saia Burgess Controls the product maturation process is represented with colour codes. These are described in the table below.

These colour codes are used on a dedicated web-page: [www.sbc-support.com/services/product-status](http://www.sbc-support.com/services/product-status).

They document the actual status of all products currently in field trials or market launch. Please consult the web-page if you wish to use a product marked in this catalogue as „\* Not released at time of printing“.

\* Not released at time of printing. For information about product status, see page XXX.

### Meaning of product status colour codes

	Function/design	Logistics/availability	Support
blue	Series production improvements have been incorporated. Final polish applied to design and function.	Product quantities have reached target volume and flow smoothly even when demand surges.	Training for product is standardized. Online support and FAQs established.
green	Products are available in series production quality and may be used with no particular technical constraints or risks.	Unrestricted sale. Products from our own production are available ex stock. Shipping volume is on the rise.	All SBC sales and support organizations have the necessary product skills. Its use can be fully supported.
orange	Products are available in series production quality. In the pilot phase, any deficits of function or design are found and corrected.	Products for 'restricted' sale. Delivery not yet ex stock. Quantity limited. Customers are informed about pilot status of product.	Product is known throughout organization. Support capability is still limited to a few individuals.
red	Laboratory and functional models are available for laboratory and field trials. Not for sale. Not for use in customer production setting.	No product orders accepted. Scheduling in a new key project may well be possible. Inquire about delivery dates!	Developers and product managers advise on function and look after laboratory and field trials.







## Type Index

Article	Weight [g]	Catalogue page
4 104 7420 0	1	125
4 104 7485 0	4	125
4 104 7493 0	10	34
4 104 7502 0	8	34
4 104 7515 0	8	34
4 104 7539 0	150	-
4 104 7719 0	189	52
4 104 7720 0	189	52
4 104 7758 0	106	52
4 104 7759 0	56	57
4 109 4849 0	10	67
4 109 4873 0	25	-
4 109 4881 0	25	-
4 111 4927 0	40	67
4 121 4910 0	70	-
4 310 8681 0	10	67
4 310 8686 0	2	33, 34
4 310 8723 0	100	33, 34
4 310 8750 0	-	-
4 310 8755 0	-	-
4 310 8756 0	-	-
4 329 4819 1	1	33, 34
4 405 4847 0	17	52
4 405 4869 0	9	52
4 405 4916 0	20	52
4 405 4917 0	20	52
4 405 4918 0	20	52
4 405 4919 0	20	52
4 405 4920 0	20	52
4 405 4921 0	9	-
4 405 4931 0	5	-
4 405 4932 0	6	-
4 405 4933 0	7	-

Article	Weight [g]	Catalogue page
4 405 4934 0	8	34
4 405 4935 0	9	-
4 405 4936 0	11	34
4 405 4937 0	15	-
4 405 4938 0	15	-
4 405 4941 0	60	67
4 405 4952 0	15	34
4 405 4954 0	15	34
4 405 4955 0	16	-
4 405 4956 0	15	34
4 405 4995 0	12	34
4 405 4998 0	13	34
4 405 5027 0	6	34
4 405 5028 0	4	34
4 405 5048 0	6	34, 52
4 405 5054 0	9	52
4 405 5055 0	9	-
4 405 5056 0	9	-
4 405 5057 0	9	-
4 405 5066 0	11	36
4 405 5079 0	5	36
4 507 4817 0	3	34, 49, 52, 57, 61, 65
4 639 4898 0	10	34
AAE1D5F10KR3A00	130	124
ALD1B5F10KA2A00	75	118, 124
ALD1B5F10KA3A00	75	124
ALD1B5FS00A2A00	80	118, 121
ALD1B5FS00A3A00	80	121
ALD1D5F10KA2A00	80	118, 124
ALD1D5F10KA3A00	75	124
ALD1D5FD00A2A00	80	118, 123
ALD1D5FD00A3A00	80	123
ALD1D5FM00A2A00	80	118, 122

Article	Weight [g]	Catalogue page
ALD1D5FM00A3A00	80	122
ALD1D5FS00A2A00	80	118, 121
ALD1D5FS00A3A00	80	121
ALE3B5F10KC2A00	215	118, 124
ALE3B5F10KC3A00	215	124
ALE3B5F500C2A00	230	118, 121
ALE3B5F500C3A00	230	121
ALE3D5F10KA2A00	220	118, 124
ALE3D5F10KA3A00	220	124
ALE3D5F11KC3A00	220	124
ALE3D5FD10C2A00	190	118, 123
ALE3D5FD10C3A00	190	123
ALE3D5FM10C2A00	190	118, 122
ALE3D5FM10C3A00	190	122
ALE3D5FS10C2A00	190	118, 121
ALE3D5FS10C3A00	190	121
AWC3D5WS00C2A00	190	118, 121
AWD1D5WS00A2A00	80	118, 121
AWD3B5W10MC2A00	190	118, 124
AWD3B5W10MC3A00	190	124
AWD3B5WS00C2A00	190	118, 121
AWD3B5WS00C3A00	190	121
AWD3D5W10MC2A00	200	118, 124
AWD3D5W10MC3A00	200	124
AWD3D5WD00C2A00	190	118, 123
AWD3D5WD00C3A00	190	123
AWD3D5WM00C2A00	190	118, 122
AWD3D5WM00C3A00	190	122
AWD3D5WS00C2A00	190	118, 121
AWD3D5WS00C3A00	190	121
CJ211	52	-
CJ250	40	-
KFD11JVTN	117	140

Article	Weight [g]	Catalogue page
KFD12JVTN	116	140
KFE102NE1N	200	143
KFE103NE1N	200	143
KFE300NE9N	200	143
KFE302NE9N	200	143
KFT100JE1N	160	143
KFT200KE1N	200	143
KOL251H7MKVFN00	60	142
KOL360H7MRVFN00	60	142
KOP160J7MWVFN00	120	142
KOP170J7MWVFN00	120	142
KOP219K7MWWAN00	120	142
KOP560K7MWVFN00	160	142
PCD1.M0160E	300	62, 192
PCD1.M2020	400	55, 192
PCD1.M2110R1	450	58, 192
PCD1.M2120	400	55, 192
PCD1.M2160	400	55, 192
PCD2.A200	60	46
PCD2.A210	60	46
PCD2.A220	65	46
PCD2.A250	65	46
PCD2.A300	45	46
PCD2.A400	40	46
PCD2.A410	40	46
PCD2.A460	40	46
PCD2.A465	35	46
PCD2.B100	45	46
PCD2.B160	50	46
PCD2.C1000	500	43, 44
PCD2.C2000	1040	43, 44
PCD2.E110	35	46
PCD2.E111	35	46
PCD2.E112	40	46
PCD2.E116	35	46
PCD2.E160	40	46
PCD2.E161	40	46

Article	Weight [g]	Catalogue page
PCD2.E165	40	46
PCD2.E166	40	46
PCD2.E500	55	46
PCD2.E610	50	46
PCD2.E611	40	46
PCD2.E613	40	46
PCD2.E616	50	46
PCD2.F2100	60	48, 56, 60, 192
PCD2.F2150	60	48, 56, 60, 192, 208
PCD2.F2210	60	48, 56, 60, 192, 219
PCD2.F2400	60	56, 60, 192, 210, 219
PCD2.F2610	60	48, 56, 60, 192, 216
PCD2.F2700	70	48, 56, 60, 192, 215
PCD2.F2710	70	48, 56, 60, 192, 215
PCD2.F2720	70	48, 56, 60, 192, 215
PCD2.F2730	70	48, 56, 60, 192, 215
PCD2.F2810	60	48, 56, 60, 192, 219
PCD2.G200	80	47
PCD2.H112	24	46
PCD2.H114	27	46
PCD2.K010	40	44, 52
PCD2.K106	100	44, 52
PCD2.K221	240	34, 52, 77
PCD2.K223	330	34, 52, 77
PCD2.K231	140	34, 52, 77
PCD2.K232	220	34, 52, 77
PCD2.K241	120	34, 52, 77
PCD2.K242	200	34, 52, 77
PCD2.K261	100	-
PCD2.K263	445	-
PCD2.K271	100	-
PCD2.K273	290	-
PCD2.K281	200	-
PCD2.K283	650	-
PCD2.K510	100	34, 52
PCD2.K511	100	34, 52

Article	Weight [g]	Catalogue page
PCD2.K520	150	34, 52
PCD2.K521	150	34, 52
PCD2.K525	280	34, 52
PCD2.K551	340	34, 52
PCD2.K552	400	34, 52
PCD2.M5440	1000	41, 44, 191
PCD2.M5540	1000	41, 44, 192
PCD2.R6000	120	16, 49
PCD2.T814	120	48
PCD2.T851	120	48
PCD2.W200	35	47
PCD2.W210	35	47
PCD2.W220	40	47
PCD2.W220Z02	40	47
PCD2.W220Z12	40	47
PCD2.W300	40	47
PCD2.W305	55	47
PCD2.W310	40	47
PCD2.W315	55	47
PCD2.W325	55	47
PCD2.W340	40	47
PCD2.W350	40	47
PCD2.W360	40	47
PCD2.W380	40	47
PCD2.W400	35	47
PCD2.W410	45	47
PCD2.W525	50	47
PCD2.W600	40	47
PCD2.W605	60	47
PCD2.W610	45	47
PCD2.W615	60	47
PCD2.W625	60	47
PCD2.W720	45	47
PCD2.W745	40	47
PCD3.A200	85	27
PCD3.A210	90	27
PCD3.A220	90	27

Article	Weight [g]	Catalogue page
PCD3.A251	90	27
PCD3.A300	70	27
PCD3.A400	65	27
PCD3.A410	65	27
PCD3.A460	65	27
PCD3.A465	70	27
PCD3.A810	100	27
PCD3.A860	110	27
PCD3.B100	70	27
PCD3.B160	66	27
PCD3.C100	420	19, 70
PCD3.C110	260	19, 70
PCD3.C110Z09	260	36, 39
PCD3.C200	440	19, 70
PCD3.C200Z09	440	36, 39
PCD3.E009	47	34
PCD3.E110	60	27
PCD3.E111	60	27
PCD3.E112	60	27
PCD3.E116	60	27
PCD3.E160	65	27
PCD3.E161	65	27
PCD3.E165	65	27, 242
PCD3.E166	65	27
PCD3.E500	80	27
PCD3.E610	65	27
PCD3.E613	65	27
PCD3.F110	80	31, 192
PCD3.F121	80	31, 192
PCD3.F150	80	31, 192
PCD3.F160	7	31, 192
PCD3.F180	80	31, 192
PCD3.F210	100	31, 192, 219
PCD3.F215	100	31, 182, 208
PCD3.F221	80	31, 192, 219
PCD3.F240	80	31, 192, 210, 219
PCD3.F261	80	31, 192, 216

Article	Weight [g]	Catalogue page
PCD3.F270	80	31, 192, 215
PCD3.F271	80	31, 192, 215
PCD3.F272	80	31, 192, 215
PCD3.F273	80	31, 192, 215
PCD3.F281	80	31, 192, 219
PCD3.H112	65	27
PCD3.H114	70	27
PCD3.K010	50	21
PCD3.K106	170	21, 44
PCD3.K116	190	21, 44
PCD3.K225	185	73
PCD3.K261	140	-
PCD3.K263	140	-
PCD3.K281	140	-
PCD3.K283	140	-
PCD3.K800	270	-
PCD3.K810	400	-
PCD3.K860	200	-
PCD3.K861	170	-
PCD3.M2030V6	920	35, 193
PCD3.M2130V6	920	35, 193
PCD3.M2230A4T5	920	37, 39, 193
PCD3.M2330A4T1	940	37, 39, 193
PCD3.M2330A4T3	960	37, 39, 193
PCD3.M2330A4T5	920	37, 39, 193
PCD3.M3120	640	25, 192
PCD3.M3230	640	25, 192
PCD3.M3330	640	25, 192
PCD3.M5340	800	24, 192
PCD3.M5440	820	24, 192
PCD3.M5540	820	24, 192
PCD3.M5560	820	23, 192
PCD3.M6560	820	23, 192
PCD3.M6860	820	23, 192
PCD3.R010	60	34
PCD3.R550M04	60	32
PCD3.R551M04	60	-

Article	Weight [g]	Catalogue page
PCD3.R560	60	32, 209
PCD3.R561	80	32
PCD3.R562	80	32, 209
PCD3.R580	60	32, 211
PCD3.R582	60	32, 211
PCD3.R600	80	32
PCD3.T665	460	70, 72
PCD3.T666	480	70, 72
PCD3.T760	460	73
PCD3.W200	60	28
PCD3.W210	60	28
PCD3.W220	65	28
PCD3.W220Z03	65	28
PCD3.W220Z12	65	28
PCD3.W300	65	28
PCD3.W305	80	28
PCD3.W310	65	28
PCD3.W315	80	28
PCD3.W325	80	28
PCD3.W340	65	28
PCD3.W350	65	28
PCD3.W360	65	28
PCD3.W380	80	28
PCD3.W400	60	28
PCD3.W410	45	28
PCD3.W525	80	28
PCD3.W600	60	28
PCD3.W605	80	28
PCD3.W610	45	28
PCD3.W615	80	28
PCD3.W625	80	28
PCD3.W720	85	28
PCD3.W745	95	28
PCD3.W800	80	28
PCD7.D170	260	96
PCD7.D230	380	96
PCD7.D230Z11	380	-

Article	Weight [g]	Catalogue page
PCD7.D231	380	96
PCD7.D231Z11	380	-
PCD7.D232	390	96
PCD7.D232Z11	390	-
PCD7.D3100E	40	50
PCD7.D410-IWS	850	90
PCD7.D410-OWS	1300	90
PCD7.D410VT5F	2000	88, 89
PCD7.D410VT5Z11	2000	-
PCD7.D410VTCF	2000	86, 87
PCD7.D410VTCZ11	2000	-
PCD7.D412DT5F	2700	88, 89
PCD7.D412DT5Z11	2700	-
PCD7.D412DTPF	2700	86, 87
PCD7.D412DTPZ11	2700	-
PCD7.D412-IWS	1200	90
PCD7.D412-OWS	1600	90
PCD7.D450WTPF	475	86, 87
PCD7.D450WTPZ11	475	-
PCD7.D457-IWS2	1500	90
PCD7.D457-OWS2	1500	90
PCD7.D457VT5E0	1000	129
PCD7.D457VT5F	1000	88, 89
PCD7.D457VT5Z11	1000	-
PCD7.D457VTCF	1000	86, 87
PCD7.D457VTCZ11	1000	91
PCD7.D457VTCZ33	1000	91
PCD7.D457VTCZ34	1000	-
PCD7.D457VTCZ35	1000	91
PCD7.D457VTCZ36	1000	91
PCD7.D470WTPF	475	86, 87
PCD7.D470WTPZ11	475	-
PCD7.D5100TL010	4100	94, 95
PCD7.D5120TL010	4100	94, 95
PCD7.D6150TA010	6000	94, 95
PCD7.F110S	7	31, 36, 39, 48, 56, 60, 64

Article	Weight [g]	Catalogue page
PCD7.F121S	7	31, 36, 39, 48, 56, 60, 64
PCD7.F150S	7	31, 36, 39, 48, 56, 60, 64
PCD7.F180S	7	31, 36, 39, 48, 56, 60, 64, 219
PCD7.F7500	100	48
PCD7.H104D	170	116
PCD7.H104SE	170	116, 124
PCD7.H108S	180	117
PCD7.K412	146	-
PCD7.K413	180	-
PCD7.K422	104	-
PCD7.K423	146	-
PCD7.K456	180	-
PCD7.K830	380	79
PCD7.K840	60	-
PCD7.L100	95	74
PCD7.L110	97	74
PCD7.L120	120	74
PCD7.L121	368	74
PCD7.L130	80	74
PCD7.L200	95	74
PCD7.L210	95	74
PCD7.L252	100	141
PCD7.L260	50	141
PCD7.L290	25	141
PCD7.L291	25	141
PCD7.L300	95	74
PCD7.L310	95	74
PCD7.L320	150	74
PCD7.L400	95	74
PCD7.L410	150	74
PCD7.L450	100	74
PCD7.L452	250	141
PCD7.L490	20	141
PCD7.L500	90	74
PCD7.L600-1	500	105
PCD7.L601-1	500	105

Article	Weight [g]	Catalogue page
PCD7.L603-1	500	105
PCD7.L604-1	500	105
PCD7.L610	500	105
PCD7.L611	500	105
PCD7.L614	500	105
PCD7.L615	250	105
PCD7.L616	250	105
PCD7.L620	500	107
PCD7.L621	500	107
PCD7.L622	500	107
PCD7.L623	800	107
PCD7.L630	250	108
PCD7.L631	250	108
PCD7.L632	250	108
PCD7.L640	250	108
PCD7.L641	250	108
PCD7.L642	250	108
PCD7.L644	250	108
PCD7.L645W	200	108
PCD7.L645B	200	108
PCD7.L650	250	107
PCD7.L651	100	109
PCD7.L660	250	109
PCD7.L661	100	109
PCD7.L662	250	109
PCD7.L663	250	109
PCD7.L665	100	109
PCD7.L666	100	109
PCD7.L670	100	110
PCD7.L670-30	300	110
PCD7.L670-50	500	110
PCD7.L671	100	110
PCD7.L672	50	107
PCD7.L672-10	100	107
PCD7.L672-50	500	107
PCD7.L673	200	110
PCD7.L790N	250	103

Article	Weight [g]	Catalogue page
PCD7.L791N	250	103
PCD7.L792N	250	103
PCD7.L793N	250	103
PCD7.R550M04	10	32, 49, 56, 60, 64
PCD7.R551M04	10	245, 247
PCD7.R560	10	32, 49, 56, 60, 64, 209
PCD7.R562	10	32, 49, 56, 60, 64, 209
PCD7.R580	10	32, 49, 56, 60, 64, 211
PCD7.R582	10	32, 49, 56, 60, 64, 211
PCD7.R610	10	32, 49, 56, 60, 64, 129, 131
PCD7.R-CF1024	20	-
PCD7.R-CF128	20	-
PCD7.R-CF2048	20	-
PCD7.RD4-SD	35	-
PCD7.R-MSD1024	10	16, 32, 39, 49, 129, 131
PCD7.R-SD1024	10	16, 32, 39, 49
PCD7.R-SD256	10	-
PCD7.R-SD512	10	16, 32, 39, 49
PCD7.T161	80	74, 139
PCD7.T162	80	74, 139
PCD7.W600	15	55, 59, 63
PCD8.K111	200	67
PCD8.K120	260	206
PCD8.OPC-1	300	187
PCD8.OPC-3	300	187
PCD8.OPC-5	300	187
PCD8.OPC-DEMO	300	187
PCD8.OPC-OEM	300	187
PCD8.OPC-UL	300	187
PCD8.PG5-CORE	—	179
PCD8.PG5-DEMO	—	179
PCD8.PG5-ENDUSER	—	179
PCD8.PG5-EXTEND	—	179
PCD8.PG5-FBOXBLD	—	179

Article	Weight [g]	Catalogue page
PCD8.PG5-HVAC	—	179
PCD8.PG5-LIBDDC	—	179
PCD8.PG5-LIBHVAC	—	179
PCD8.PG5-LIBLON	—	179
PCD8.PG5-LIBMODEM	—	179
PCD8.PG5-LIBMPBUS	—	179
PCD8.PG5-LIBROOM	—	179
PCD8.PG5-UPGRDE	—	179
PCD8.PG5-WEB8-SA	—	179
PCD8.SBC.NETSUITE	300	186
PCD8.VP-BASIC	420	185
PCD8.VP-DEMO	420	185
PCD8.VP-ESPA	—	185
PCD8.VP-GE10	—	185
PCD8.VP-GE2	—	185
PCD8.VP-GE5	—	185
PCD8.VP-GEUL	—	185
PCD8.VP-MALM	—	185
PCD8.VP-MALMESPA	—	185
PCD8.VP-MALMVOICE	—	185
PCD8.VP-MINI	420	185
PCD8.VP-OPC1	—	185
PCD8.VP-OPC2	—	185
PCD8.VP-OPC3	—	185
PCD8.VP-PCALC	—	185
PCD8.VP-PCHART	—	185
PCD8.VP-PRT	—	185
PCD8.VP-PSMS	—	185
PCD8.VP-SBUS10K	—	185
PCD8.VP-SBUS25K	—	185
PCD8.VP-SBUS50K	—	185
PCD8.VP-SBUSUL	—	185
PCD8.VP-SNMP	—	185
PCD8.VP-STD	420	185
PCD8.VP-UPGRADE	—	185
PCD8.VP-WEB2	—	185

Article	Weight [g]	Catalogue page
PCD8.VP-WEB20	—	185
PCD8.VP-WEB5	—	185
PCS1.C420	1210	66, 67
PCS1.C421	1155	66, 67
PCS1.C422	1150	66, 67
PCS1.C423	1100	66, 67
PCS1.C620	1210	66, 67
PCS1.C621	1155	66, 67
PCS1.C622	1135	66, 67
PCS1.C623	1080	66, 67
PCS1.C820	1210	66, 67
PCS1.C821	1155	66, 67
PCS1.C822	1135	66, 67
PCS1.C823	1080	66, 67
PCS1.C880	1210	66, 67
PCS1.C881	1155	66, 67
PCS1.C882	1135	66, 67
PCS1.C883	1080	66, 67
PPCD8.VP-SBUS10K	—	185
Q.G736-AS2	200	79
Q.M716-KS1	250	56, 79
Q.NET-5TX	230	71, 138
Q.NET-8TX	400	71, 138
Q.OWSD457VT5E0	2900	129
Q.PS-AD1-2403	200	135, 137
Q.PS-AD1-2405	200	135, 137
Q.PS-AD2-2402F	300	135, 136
Q.PS-AD2-2405F	600	135, 136
Q.PS-AD2-2410F	600	135, 136
Q.PS-AD3-2405	700	135, 137
Q.PS-ADB-2405-1	680	135, 137
Q.SRC65-RS485E	200	214
Q.STC65-RS485E	250	214
Q.T726-RS1	240	79
Q.VM-09SAS/18	80	79









# Index of authors

## A Products

A 1	PCD – Automation station	
A 1.1	PCD – Basics	Kostas Kafandaris
A 1.2	PCD3	Urs Jäggi / Jonas Affolter
A 1.3	PCD2	Urs Jäggi / Daniel Ernst
A 1.4	PCD1	Daniel Keinath / Oliver Greune
A 1.5	PCS1	Daniel Keinath / Oliver Greune
A 1.6	Remote data points	Urs Jäggi / Bernhard Portner
A 1.7	Automation devices accessories	Daniel Ernst / Bernhard Portner
A 2	HMI Visualisation operating	Daniel Schossmeier
A 3	Dedicated room controllers	Bernhard Portner
A 4	Consumption data acquisition	Pascal Hurni
A 5	Cabinet components	Daniel Ernst / Bernhard Portner

## B Basic systems

B 1	SBC Software	Jürg Beyeler
B 2	Communication & interaction	Urs Jäggi / Oliver Greune
B 3	S-Web	Daniel Schossmeier / Urs Jäggi

### Be better informed – call up further information using QR codes and web codes

You can use this additional service for readers to access further information that can be called up on the Internet in the form of collections of links.  
And here's how it works:



#### Information with a QR code:

- Scan the QR code using your mobile device.
- You will be taken to a list of links with related information or directly to the desired content.

#### Information with a web code (= number):

- Open [www.saia-pcd.com/qr](http://www.saia-pcd.com/qr) in your browser
- Enter the desired web code in the «Web code» input field.
- A selection of related links that you can use to call up the desired information is generated.

#### Imprint Publisher

Saia-Burgess Controls AG  
Bahnhofstrasse 18 | 3280 Murten, Switzerland  
T +41 26 672 72 72 | F +41 26 672 74 99  
[www.saia-pcd.com](http://www.saia-pcd.com) | [info@saia-pcd.com](mailto:info@saia-pcd.com)

Subject to changes to technical details and figures. The latest version is available at: [www.sbc-support.com](http://www.sbc-support.com)

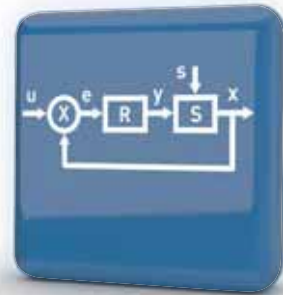

## Saia-Burgess Controls AG

Bahnhofstrasse 18  
3280 Murten, Switzerland  
T +41 26 672 72 72  
F +41 26 672 74 99  
[www.saia-pcd.com](http://www.saia-pcd.com)  
[info@saia-pcd.com](mailto:info@saia-pcd.com)