

## Temperature Sensors with G1/2" Hygienic

### Application

- temperature measurement in pipes and vessels
- front flush mounting
- high accuracy temperature measurement

### Application Examples

- controlling of CIP- / SIP-process
- measurement in vessels with agitators
- temperature measurement in UHT-plants

### Hygienic Design / Process Connection

- hygienic measurement point which is easy to sterilize (EHEDG, 3A-certificates)
- because of elastomer free sealing system, the connection will be without gaps and crevices
- CIP-/ SIP-cleaning up to 140°C
- food compatible materials according to FDA
- sensor completely made of stainless steel resp. PEEK (only front flush)
- adapters available for all current process connections

### Features

- front flush mounting available
- available with and without integrated transmitter
- defined position of the cable entry

### Options / Accessories

- 2xPt100
- transmitter mpu-4 for different ranges, output 4-20mA
- Pt100 chip with other classes of accuracy, e.g. 1/3 DIN B, 1/10 DIN B
- integrated LC-display mpu-LCD in the connecting head
- transmitters for PROFIBUS, HART, EX-zone
- fast response sensor tip 3mm and 4mm
- neck tube for temperature up to 250°C
- cables available in PTFE and other lengths

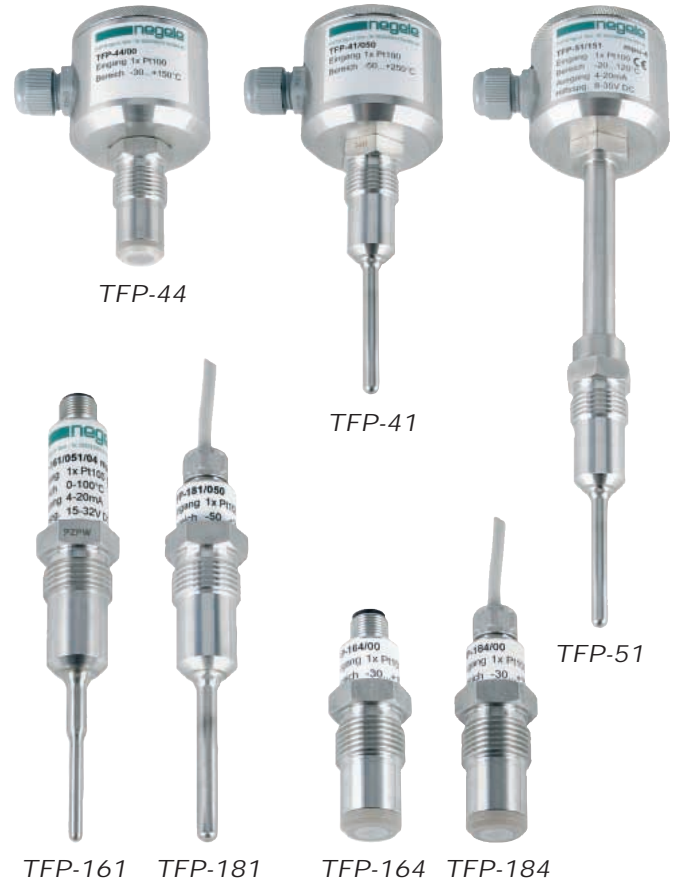

### Order Code

Temperature sensor	Model head Ø55mm	Insertion length [mm]	Transmitter	Range	Electrical connection	Diameter sensor tip	Further options
TFP-41	neck tube	50, 100, 150, 250mm	without*	-10...+40°C	PG*	3mm	1/3B
TFP-51	neck tube	special length	mpu-4	0...50°C	M12	4mm	1/10B
TFP-... / ..2	2xPt100	(for all sensors, except "front flush")	mpu-4p (programmable)	0...100°C		6mm*	2xPG**
TFP-44	front flush		mpu-10 (Profibus PA)	0...150°C		(for all sensors except 'front flush')	2xM12**
			mpu-4ex (EX-zone)	0...200°C			
			mpu-H (HART Protocol)				
			mpu-LCD (integ. display)				
Order example:		TFP-41/ 100 / mpu-4 / 0...150°C / M12 / 4mm / 1/3B				** only for model 2xPt100.	
Temperature sensor	Model head Ø19mm	Insertion length [mm]	Transmitter mpu-m	Range	Electrical connection	Diameter sensor tip	Further options
TFP-161		50, 100, 150, 250mm	.m	-10...+40°C	M12*	3mm	1/3B
TFP-181	cable	special length		0...50°C	cable*	4mm	1/10B
TFP-164	front flush	(for all sensors, except 'front flush')		0...100°C		6mm*	
TFP-184	cable and front flush			0...150°C	M12*		PTFE cable (TFP-181 and TFP-184 only)
				0...200°C	cable*		
Order example:		TFP-161/ 100 .m / 0...150°C / 4mm				*standard, no declaration needed.	

## Specification Temperature Sensor

Process connection	G1/2" hygienic	weld-in sleeve e.g. EMK-132 or EHG-25 / 1/2"
Insertion length	standard	0, 50, 150, 250mm
Material	head	stainless steel 303 (1.4305)
	protection tube	316 L (1.4404)
	TFP-44, -164, -184	PEEK
Sensing resistor	acc. ITS 90	1xPt100 class A
Protection class		IP69K

Temperature range	ambient	-50...+80°C
	sensor tip	-50...+250°C
	TFP-44, -164, -184	-50...+150°C
Operating pressure		max. 10bar
	TFP-44, -164, -184	max. 6bar
Electrical connection	cable junction	M16x1,5 (PG)
	plug-in	M12-plug 303 (1.4305) 4pins. 303 (1.4305) 4pins.
	fixed cable 2,5m	LIYY 4x0,25mm <sup>2</sup>
	option (>90°C)	PTFE 4x0,14mm <sup>2</sup>

## Transmitter mpu-4, -4p, -10, -4ex, -HART

Temperature range	standard	-10...+40, 0...50°C 0...100 / 150 / 200°C
Accuracy		<±0,1% (full scale)
Temperature drift	zero, span	<0,01%/K (full scale)
Electrical connection	supply	8...35VDC
Output	analog	4-20mA
Temperature range	ambient	-40...+85°C
	storage	-40...+120°C
Humidity	without condensate	0...98%

## Transmitter mpu-m

Temperature range	standard	-10...+40, 0...50°C 0...100 / 150 / 200°C
Accuracy		<±0,2% full scale
Temperature drift	zero, span	<0,02% full scale /K
Electrical connection	supply	12...36VDC
Output	analog	4-20mA
Temperature range	ambient	-50...+80°C

## Accuracy Class Pt100

Tolerances of Pt100 acc. ITS 90

Pt100	class B	class A	class 1/3B	class 1/10B
0°C	±0,3K	±0,15K	±0,10K	±0,03K
100Ω	±0,12Ω	±0,06Ω	±0,04Ω	±0,01Ω
100°C	±0,8K	±0,35K	±0,27K	±0,08K
138,5Ω	±0,30Ω	±0,13Ω	±0,10Ω	±0,03Ω

## Sensor tip diameter and response time

All temperature sensors are available with smaller sensor tips, to ensure a shorter response time. The below-mentioned times are according to a PT100 sensor in boiling water.

### Sensor tip ø6mm

validity:  $t_{50} \leq 3,0s$   
90%-time:  $t_{90} \leq 8,0s$

### Sensor tip ø4mm

validity:  $t_{50} \leq 2,4s$   
90%-time:  $t_{90} \leq 6,5s$

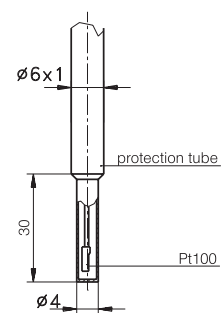
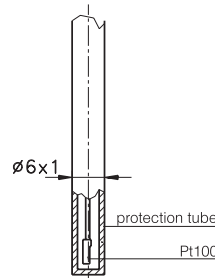

## Option: mpu-LCD

integrated LC-Display in the connection head

Specifications: please look on separate product informations



temperatur sensor  
with mpu-LCD  
(view from top)

### Features

- 4-digit display with green backlight
- temperature measurement in °C und °F
- easy range select by one button
- direct connection to the PLC
- lower costs for wiring because of 2-wire technology
- suitable for sensor monitoring

### Sensor tip ø3mm

validity:  $t_{50} \leq 0,5s$   
90%-time:  $t_{90} \leq 1,5s$

### Sensor front flush

validity:  $t_{50} \leq 5,7s$   
90%-time:  $t_{90} \leq 33,2s$

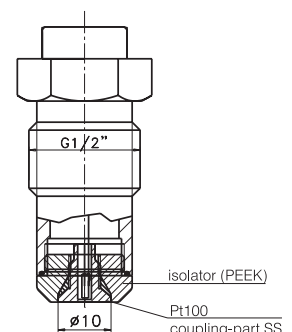
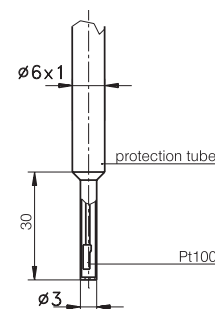

## Accessories



Simulator hsg-3



Calibration Device htr

## Drawings

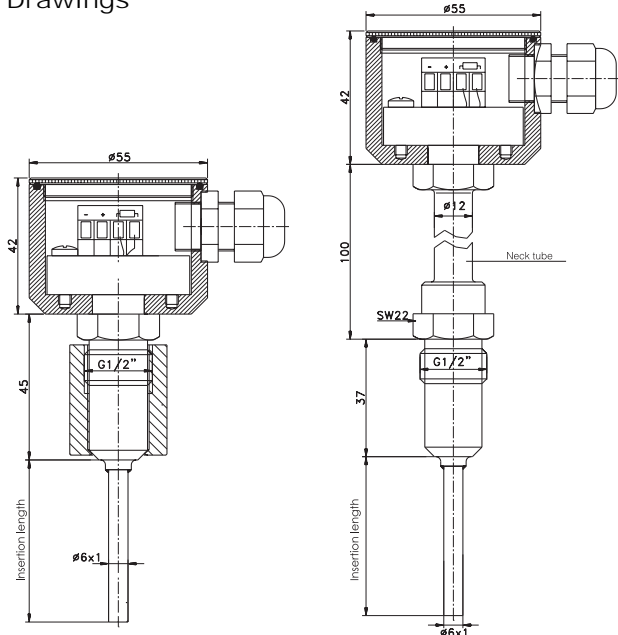

TFP-41

TFP-51

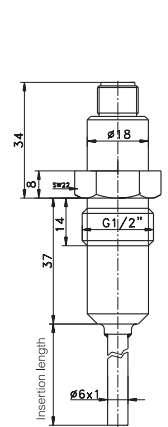

TFP-161

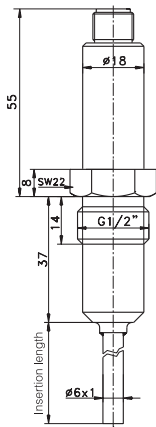

TFP-161.m

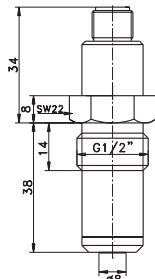

TFP-164

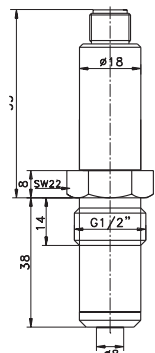

TFP-164.m

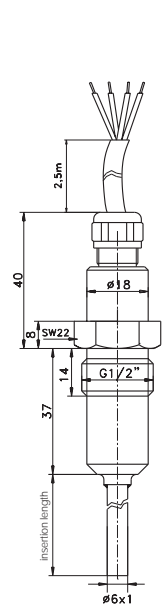

TFP-181

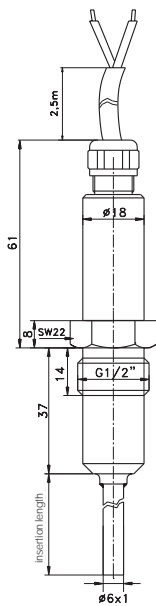

TFP-181.m

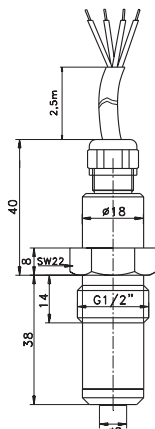

TFP-184

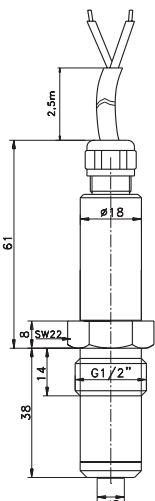

TFP-184.m

## Electrical connections

without transmitter

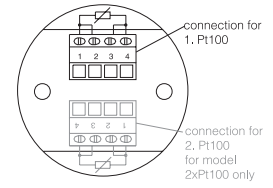

with transmitter  
mpu-4, -4p, -4ex, -10, -HART

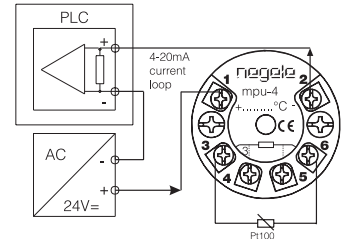

without transmitter  
M12 connection  
(view from the top)

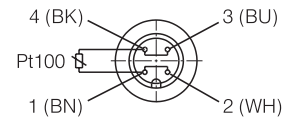

with transmitter mpu-m  
M12 connection  
(view from the top)

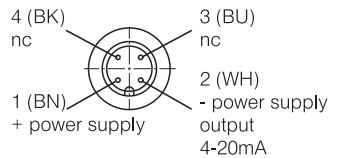

without transmitter  
cable connection

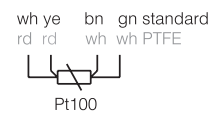

option 2xPt100  
cable connection

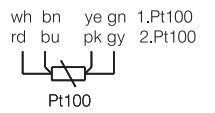

with transmitter mpu-m  
cable connection

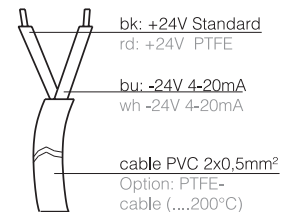







## Table Torque

Thread size	Sealing system	Torque min. [Nm]	Torque max. [Nm]
G1/2"	PEEK / SS	5	10
G1/2"	SS / SS	5	20

Important information: Use only Negele weld-in systems, to guarantee a safe function of the measurement point!

## Process connection G1/2" hygienic

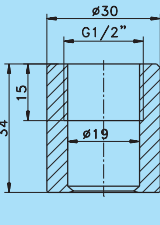
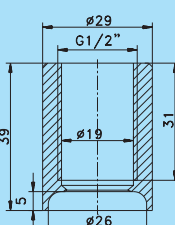
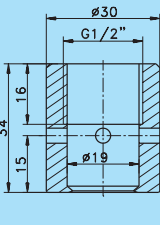
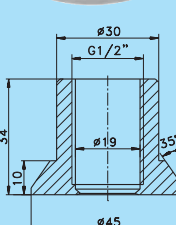
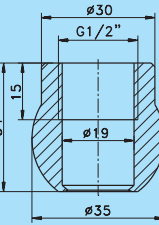
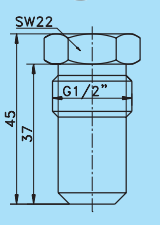



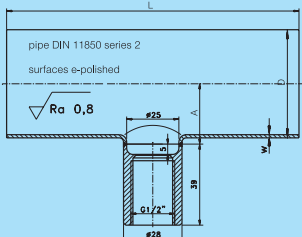

Cylindrical weld-in fitting (standard)	Cyl. fitting with weld-on ring (standard)	Cylindrical fitting with control-holes	Weld-in fitting with collar	Weld-in ball	Dummy flange BST
for vessels	for installation in pulled-out pipes	for vessels, with leakage detection	for thick-walled vessels	for sloped installation	to close existing measurement point
					
					
EMZ-132	EMS-132	EMZ-131	EMK-132	KEM-132	BST-130

## Dimension table EHG-... / 1/2"

Type	DN	L[mm]	A[mm]
EHG-25 / 1/2"	25	100	15
EHG-40 / 1/2"	40	120	22
EHG-50 / 1/2"	50	140	29
EHG-65 / 1/2"	65	160	38
EHG-80 / 1/2"	80	180	46

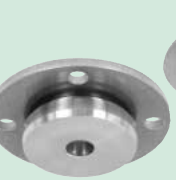
## Overview of all available process connections

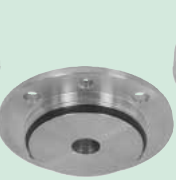
Thread size	TriClamp	Dairy flange (DIN11851)	DRD (press ring optional available)	Varivent-Inline	APV-Inline	BioControl	Adapter G1/2" hyg. / G1" hyg.
G1/2" adapter							
Pipe size							
DN25	AMC-132/1"-1,5"	AMK-132/25		AMV-132/25	-	-	AMG-1
DN40	AMC-132/1"-1,5"	AMK-132/40		AMV-132/40	AMA-132	AMB-50/1/2"	
DN50	AMC-132/2"	AMK-132/50	AMK-132/50	AMV-132/40	AMA-132	and	
DN65	AMC-132/3"	AMK-132/65		AMV-132/40	AMA-132	AMB-65/1/2"	
DN80	AMC-132/80	AMK-132/80	(only one size)	AMV-132/40	AMA-132	from DN40	
DN100	AMC-132/4"	AMK-132/100		AMV-132/40	AMA-132	up to DN100	